

25th
ANNIVERSARY

STARAX®

Yaşam kaliteniz...

2021-2 Fiyat Listesi

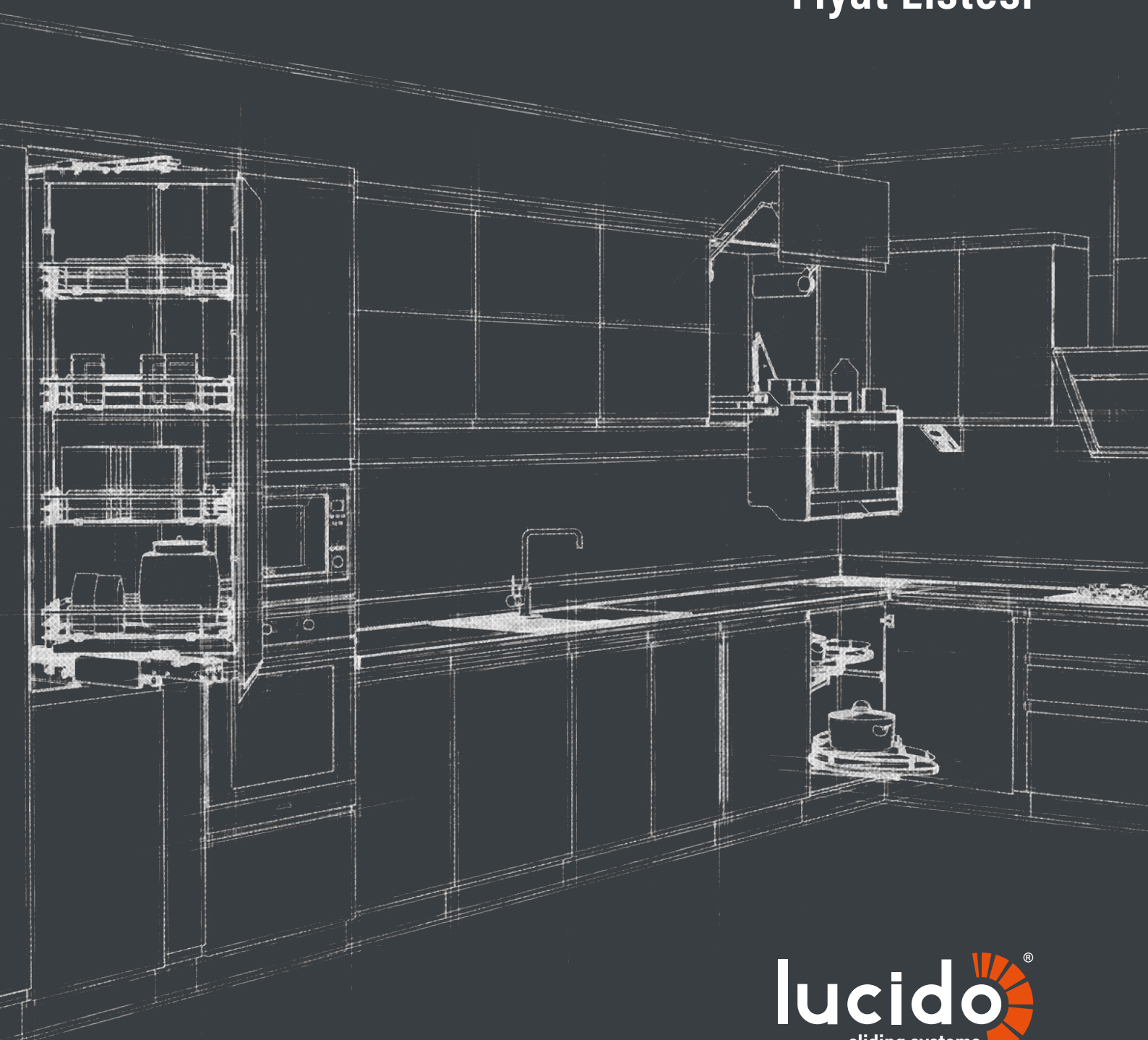

lucido®
sliding systems





STARAX 1996 yılında mutfak ve mobilya aksesuarları sektöründe hizmet vermek amacı ile kurulmuştur. Kurulduğumuz günden bu yana her yıl artan ürün çeşitliliği, büyüyen iş gücü ve kapasitemizle, doğaya, çevreye ve çalışanlarımıza saygı bilinciyle 25. yılımızda Tekirdağ Velimeşe Organize Sanayi Bölgesindeki 32.500m² kapalı, 10.000m² açık alana sahip fabrika binamızda genç dinamik çalışanlarımız ile kaliteden ödün vermeden üretime devam etmekteyiz.

AR-GE'ye verdiğimiz önem ile her geçen yıl ürün yelpazemizi geliştirerek sektöre yeni bir renk katmaktayız. Artan kapasitemiz, güçlenen deneyimli kadromuz ve yeni ileri teknoloji tesis ve makinelerimizle siz değerli müşterilerimize daha iyi hizmet vermenin haklı gururunu yaşıyoruz.

Yurtiçinde aranan marka olma özelliğimizi 90 ülkeye yaptığımız düzenli ihracatlarla yurtdışına taşımış olmanın yanı sıra, yeniliklere açık ve kendisiyle rekabet içinde olan bir firma olarak her geçen yıl vizyonumuzu genişletmekteyiz.

Ürün gruplarımız; fonksiyonel kiler sistemleri, ergonomik tezgah altı ve köşe dolabı üniteleri, mutfaklarınıza yeni bir estetik anlayışı getiren set arası aksesuarlar, dolap içi ideal kullanım alanları açan raf grupları, hayatımızı kolaylaştıran gardrop aksesuarları, çok amaçlı kolon grupları ve modern banyo aksesuarlarından oluşmaktadır.

Siz değerli müşterilerimizin güveni ve desteği ile her zaman daha çok çalışarak yolumuza devam edeceğiz...

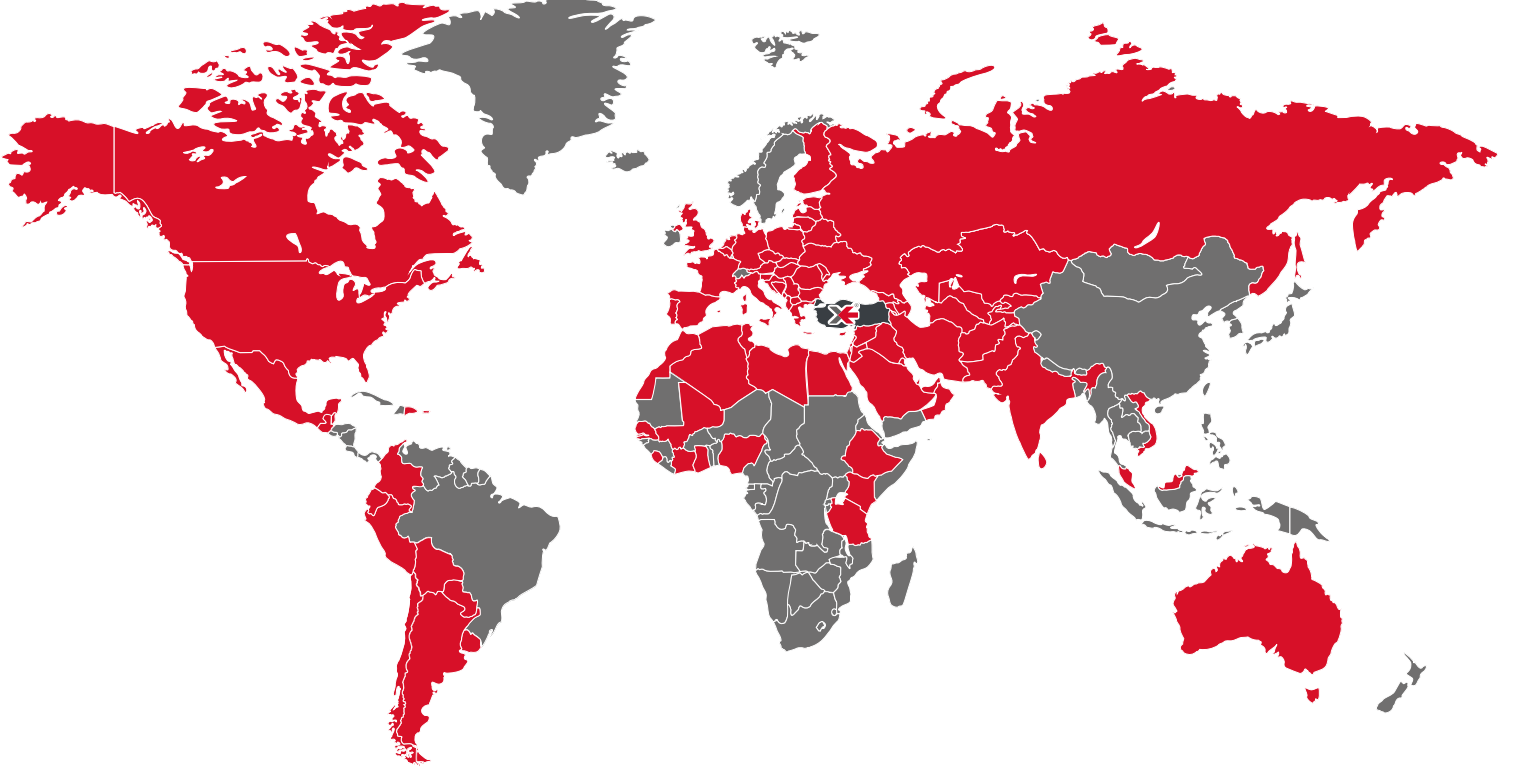

STARAX brand has been established in 1996 to serve in the kitchen and furniture accessories sector. Till today, every year we improved our product range, workpower and capacity, with respect to nature, environment and employees, we continue our production in our 25th year in our factory at Tekirdag Velimese Organized Industrial Zone with 32.500m² closed, 10.000m² open area and with young dynamic staff without compensation from product quality.

We are adding every year color to the sector by developing our product range and with importance we give to R&D. We are also proud of providing a better service to our valued customers with our increasing capacity, stronger experienced staff and new advanced technology facilities and machines.

Our brandname is well known in domestic market and we also export to around 90 different countries regularly. We are following changing trends, innovations and competing itself hereby every our vision is growing up.

Our product groups are functional larder systems, ergonomic under-workbench and corner units, midway accessories that bring new minds into our kitchens, shelf groups opening new useful areas inside of cupboards, wardrobe accessories that makes our live easier, multifunctional column groups and modern bathroom accessories.

We'll continue our way with the support and trust of our customers and always work more...



Kod : Ürün sipariş kodu (örn. S-1234-)
 Renk Seçenekleri : Ürün sipariş koduna ek olarak belirlenen renk kodu (örn. S-1234-C)



W : Ürünün en büyük genişlik ölçüsü (mm)
 D : Ürünün en büyük derinlik ölçüsü (mm)
 H : Ürünün en büyük yükseklik ölçüsü (mm)
 Ø : Ürünün en büyük çap ölçüsü (mm)
 C : Modül kapak genişlik ölçüsü (mm)
 Koli : Bir kolideki ürün miktarı (adet)
 2 Koli : İki kolideki ürün miktarı (adet)
 Hacim : Ürünün toplam koli hacmi (m³)
 Ağırlık : Ürünün toplam koli ağırlığı (kg)
 Yön : Ürünün modül içinden çıktığı yön (Sol / Sağ)
 : Yavaş ve sessiz kapanma sağlar



: Kaydırmaz yüzey



: Taşıma kapasitesi (kg)

Product Code : Products code (e.g. S-1234-)
 Color Options : Color code in addition to the product order code (eg S-1234-C)



W : The largest width of the product (mm)
 D : The largest depth of the product (mm)
 H : The largest height of the product (mm)
 Ø : The largest diameter of the product (mm)
 C : Width of the module (mm)
 Box : Product quantity in a box (pcs)
 2 Box : Product quantity in two boxes (pcs)
 Volume : Total box volume of the product (m³)
 Weight : Total box weight of the product (kg)
 Direction : Describes how the product comes out from the module (left / right)
 : Provides slow and silent closing



: Antislip Surface



: Product Carrying Capacity (kg)



Kiler

Larder

P 05-09

01



Tezgah Altı

Under-Workbench

P 10-26

02



Köşe Dolabı

Under-Workbench Corner

P 27-30

03



Set Arası

Midway

P 31-42

04



Dolap İçi Raf

Inside Cupboard Shelf

P 43-46

05



Gardırop

Wardrobe

P 47-60

06



Çok Amaçlı Kolon

Multi-Functional Column

P 61-65

07



Banyo

Bathroom

P 66-70

08



Sürme Kapak Sistemleri

Sliding Systems



Sürme Kapı Sistemleri

Sliding Door Systems



Aksesuar

Accessories

P 71-128

09



2 Sepet | 2 Baskets

Renk Seçenekleri
Color OptionsS-XXXX-C
CHROMES-XXXX-A
ANTHRACITE

Ürün Kodu				W x D x H (mm)	C (mm)	Koli	Hacim (m³)	Ağırlık kg.	
Tel	Fiyat	Ahşap	Fiyat					Tel	Ahşap
S-1101-	635,00₺	S-1501-	692,00₺	230 x 510 x 600-800	300	1	0,060	10,550	12,670
S-1102-	635,00₺	S-1502-	700,00₺	280 x 510 x 600-800	350	1	0,060	10,950	13,160
S-1103-	635,00₺	S-1503-	716,00₺	330 x 510 x 600-800	400	1	0,060	11,500	13,835
S-1104-	665,00₺	S-1504-	771,00₺	380 x 510 x 600-800	450	1	0,060	12,000	14,370
S-1105-	665,00₺	S-1505-	828,00₺	430 x 510 x 600-800	500	1	0,060	12,500	14,805
S-1106-	665,00₺	S-1506-	881,00₺	480 x 510 x 600-800	550	1	0,060	13,000	15,520

3 Sepet | 3 Baskets

Renk Seçenekleri
Color OptionsS-XXXX-C
CHROMES-XXXX-A
ANTHRACITE

Ürün Kodu				W x D x H (mm)	C (mm)	Koli	Hacim (m³)	Ağırlık kg.	
Tel	Fiyat	Ahşap	Fiyat					Tel	Ahşap
S-1107-	704,00₺	S-1507-	781,00₺	230 x 510 x 850-1100	300	1	0,076	13,000	15,050
S-1108-	704,00₺	S-1508-	809,00₺	280 x 510 x 850-1100	350	1	0,076	13,500	15,750
S-1109-	704,00₺	S-1509-	877,00₺	330 x 510 x 850-1100	400	1	0,076	14,400	16,715
S-1110-	736,00₺	S-1510-	920,00₺	380 x 510 x 850-1100	450	1	0,076	15,000	17,480
S-1111-	736,00₺	S-1511-	976,00₺	430 x 510 x 850-1100	500	1	0,076	15,200	18,085
S-1112-	736,00₺	S-1512-	1.032,00₺	480 x 510 x 850-1100	550	1	0,076	16,250	19,120

4 Sepet | 4 Baskets

Renk Seçenekleri
Color OptionsS-XXXX-C
CHROMES-XXXX-A
ANTHRACITE

Ürün Kodu				W x D x H (mm)	C (mm)	Koli	Hacim (m³)	Ağırlık kg.	
Tel	Fiyat	Ahşap	Fiyat					Tel	Ahşap
S-1113-	795,00₺	S-1513-	937,00₺	230 x 510 x 1100-1250	300	1	0,094	15,100	17,600
S-1114-	795,00₺	S-1514-	976,00₺	280 x 510 x 1100-1250	350	1	0,094	15,750	18,500
S-1115-	795,00₺	S-1515-	1.064,00₺	330 x 510 x 1100-1250	400	1	0,094	16,750	19,765
S-1116-	851,00₺	S-1516-	1.126,00₺	380 x 510 x 1100-1250	450	1	0,094	17,450	20,750
S-1117-	851,00₺	S-1517-	1.190,00₺	430 x 510 x 1100-1250	500	1	0,094	18,200	21,535
S-1118-	851,00₺	S-1518-	1.250,00₺	480 x 510 x 1100-1250	550	1	0,094	19,450	22,880

4 Sepet | 4 Baskets

Renk Seçenekleri
Color OptionsS-XXXX-C
CHROMES-XXXX-A
ANTHRACITE

Ürün Kodu				W x D x H (mm)	C (mm)	Koli	Hacim (m³)	Ağırlık kg.	
Tel	Fiyat	Ahşap	Fiyat					Tel	Ahşap
S-1119-	828,00₺	S-1519-	976,00₺	230 x 510 x 1250-1400	300	1	0,094	15,400	17,790
S-1120-	828,00₺	S-1520-	1.032,00₺	280 x 510 x 1250-1400	350	1	0,094	15,900	18,290
S-1121-	828,00₺	S-1521-	1.090,00₺	330 x 510 x 1250-1400	400	1	0,094	17,500	19,955
S-1122-	865,00₺	S-1522-	1.143,00₺	380 x 510 x 1250-1400	450	1	0,094	17,700	20,940
S-1123-	865,00₺	S-1523-	1.202,00₺	430 x 510 x 1250-1400	500	1	0,094	18,400	21,725
S-1124-	865,00₺	S-1524-	1.257,00₺	480 x 510 x 1250-1400	550	1	0,094	19,550	23,070

5 Sepet | 5 Baskets

Renk Seçenekleri
Color OptionsS-XXXX-C
CHROMES-XXXX-A
ANTHRACITE

Ürün Kodu				W x D x H (mm)	C (mm)	Koli	Hacim (m³)	Ağırlık kg.	
Tel	Fiyat	Ahşap	Fiyat					Tel	Ahşap
S-1125-	922,00₺	S-1525-	1.126,00₺	230 x 510 x 1400-1550	300	1	0,124	17,700	20,320
S-1126-	922,00₺	S-1526-	1.183,00₺	280 x 510 x 1400-1550	350	1	0,124	18,600	21,550
S-1127-	922,00₺	S-1527-	1.250,00₺	330 x 510 x 1400-1550	400	1	0,124	19,900	23,075
S-1128-	989,00₺	S-1528-	1.344,00₺	380 x 510 x 1400-1550	450	1	0,124	20,550	24,350
S-1129-	989,00₺	S-1529-	1.405,00₺	430 x 510 x 1400-1550	500	1	0,124	21,700	25,320
S-1130-	989,00₺	S-1530-	1.484,00₺	480 x 510 x 1400-1550	550	1	0,124	23,250	27,000

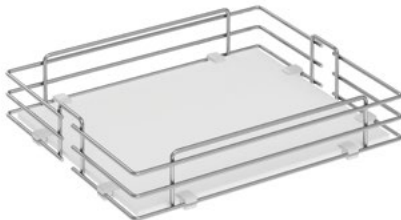



5 Sepet | 5 Baskets

Renk Seçenekleri
Color OptionsS-XXXX-C
CHROMES-XXXX-A
ANTHRACITE

Ürün Kodu				W x D x H (mm)	C (mm)	Koli	Hacim (m³)	Ağırlık kg.	
Tel	Ahşap	Ahşap	Ahşap					Tel	Ahşap
S-1131-	954,00₺	S-1531-	1.161,00₺	230 x 510 x 1550-1700	300	1	0,124	17,850	20,820
S-1132-	954,00₺	S-1532-	1.221,00₺	280 x 510 x 1550-1700	350	1	0,124	18,700	21,900
S-1133-	954,00₺	S-1533-	1.297,00₺	330 x 510 x 1550-1700	400	1	0,124	20,150	23,520
S-1134-	1.024,00₺	S-1534-	1.359,00₺	380 x 510 x 1550-1700	450	1	0,124	20,950	24,750
S-1135-	1.024,00₺	S-1535-	1.437,00₺	430 x 510 x 1550-1700	500	1	0,124	21,850	25,770
S-1136-	1.024,00₺	S-1536-	1.532,00₺	480 x 510 x 1550-1700	550	1	0,124	23,450	27,450

6 Sepet | 6 Baskets

Renk Seçenekleri
Color OptionsS-XXXX-C
CHROMES-XXXX-A
ANTHRACITE

Ürün Kodu				W x D x H (mm)	C (mm)	Koli	Hacim (m³)	Ağırlık kg.	
Tel	Fiyat	Ahşap	Fiyat					Tel	Ahşap
S-1137-	1.034,00₺	S-1537-	1.344,00₺	230 x 510 x 1700-1850	300	1	0,147	19,650	23,050
S-1138-	1.034,00₺	S-1538-	1.405,00₺	280 x 510 x 1700-1850	350	1	0,147	21,000	24,410
S-1139-	1.034,00₺	S-1539-	1.500,00₺	330 x 510 x 1700-1850	400	1	0,147	22,500	26,280
S-1140-	1.109,00₺	S-1540-	1.560,00₺	380 x 510 x 1700-1850	450	1	0,147	23,850	27,750
S-1141-	1.109,00₺	S-1541-	1.593,00₺	430 x 510 x 1700-1850	500	1	0,147	24,900	28,920
S-1142-	1.109,00₺	S-1542-	1.657,00₺	480 x 510 x 1700-1850	550	1	0,147	26,450	30,940

6 Sepet | 6 Baskets

Renk Seçenekleri
Color OptionsS-XXXX-C
CHROMES-XXXX-A
ANTHRACITE

Ürün Kodu				W x D x H (mm)	C (mm)	Koli	Hacim (m³)	Ağırlık kg.	
Tel	Fiyat	Ahşap	Fiyat					Tel	Ahşap
S-1143-	1.080,00₺	S-1543-	1.370,00₺	230 x 510 x 1850-2000	300	1	0,147	19,950	23,200
S-1144-	1.080,00₺	S-1544-	1.426,00₺	280 x 510 x 1850-2000	350	1	0,147	21,350	24,560
S-1145-	1.080,00₺	S-1545-	1.482,00₺	330 x 510 x 1850-2000	400	1	0,147	22,550	26,480
S-1146-	1.158,00₺	S-1546-	1.560,00₺	380 x 510 x 1850-2000	450	1	0,147	23,900	27,950
S-1147-	1.158,00₺	S-1547-	1.593,00₺	430 x 510 x 1850-2000	500	1	0,147	25,300	29,120
S-1148-	1.158,00₺	S-1548-	1.652,00₺	480 x 510 x 1850-2000	550	1	0,147	26,800	31,090

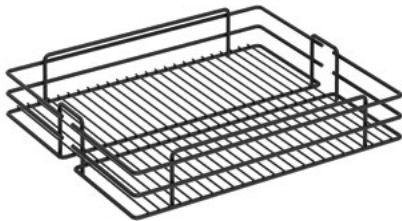
Teleskopik Kiler Sepetleri
Telescopic Larder BasketsRenk Seçenekleri
Color OptionsS-XXXX-C
CHROMES-XXXX-A
ANTHRACITE

Ürün Kodu				W x D x H (mm)	C (mm)	Koli	Hacim (m³)	Ağırlık kg.	
Tel	Fiyat	Ahşap	Fiyat					Tel	Ahşap
S-1831-	93,00₺	S-1871-	115,00₺	230 x 445 x 83	300	10	0,097	18,500	19,700
S-1832-	93,00₺	S-1872-	125,00₺	280 x 445 x 83	350	10	0,117	20,000	21,600
S-1833-	93,00₺	S-1873-	133,00₺	330 x 445 x 83	400	10	0,138	21,500	23,500
S-1834-	98,00₺	S-1874-	145,00₺	380 x 445 x 83	450	10	0,158	23,500	25,800
S-1835-	104,00₺	S-1875-	154,00₺	430 x 445 x 83	500	10	0,178	25,500	27,700
S-1836-	109,00₺	S-1876-	164,00₺	480 x 440 x 83	550	10	0,199	27,000	29,400



4 Sepet | 4 Baskets

Renk Seçenekleri
Color OptionsS-XXXX-C
CHROMES-XXXX-A
ANTHRACITE

Ürün Kodu				W x D x H (mm)	C (mm)	Koli	Hacim (m ³)	Ağırlık kg.	
Tel	Fiyat	Ahşap	Fiyat					Tel	Ahşap
S-1801-	1.279,00₺	S-1841-	1.371,00₺	230 x 510 x 1250-1400	300	1	0,094	18,500	19,580
S-1802-	1.279,00₺	S-1842-	1.406,00₺	280 x 510 x 1250-1400	350	1	0,094	19,500	20,540
S-1803-	1.279,00₺	S-1843-	1.442,00₺	330 x 510 x 1250-1400	400	1	0,094	20,000	21,400
S-1804-	1.279,00₺	S-1844-	1.481,00₺	380 x 510 x 1250-1400	450	1	0,094	21,000	22,220
S-1805-	1.279,00₺	S-1845-	1.517,00₺	430 x 510 x 1250-1400	500	1	0,094	21,500	23,080

5 Sepet | 5 Baskets

Renk Seçenekleri
Color OptionsS-XXXX-C
CHROMES-XXXX-A
ANTHRACITE

Ürün Kodu				W x D x H (mm)	C (mm)	Koli	Hacim (m ³)	Ağırlık kg.	
Tel	Fiyat	Ahşap	Fiyat					Tel	Ahşap
S-1807-	1.350,00₺	S-1847-	1.494,00₺	230 x 510 x 1400-1550	300	1	0,124	20,500	22,600
S-1808-	1.350,00₺	S-1848-	1.529,00₺	280 x 510 x 1400-1550	350	1	0,124	21,500	23,700
S-1809-	1.350,00₺	S-1849-	1.564,00₺	330 x 510 x 1400-1550	400	1	0,124	22,500	24,850
S-1810-	1.350,00₺	S-1850-	1.604,00₺	380 x 510 x 1400-1550	450	1	0,124	23,500	25,750
S-1811-	1.350,00₺	S-1851-	1.638,00₺	430 x 510 x 1400-1550	500	1	0,124	24,500	26,850

5 Sepet | 5 Baskets

Renk Seçenekleri
Color OptionsS-XXXX-C
CHROMES-XXXX-A
ANTHRACITE

Ürün Kodu				W x D x H (mm)	C (mm)	Koli	Hacim (m ³)	Ağırlık kg.	
Tel	Ahşap	Ahşap	Ahşap					Tel	Ahşap
S-1813-	1.419,00₺	S-1853-	1.517,00₺	230 x 510 x 1550-1700	300	1	0,124	20,000	22,600
S-1814-	1.419,00₺	S-1854-	1.553,00₺	280 x 510 x 1550-1700	350	1	0,124	21,000	23,700
S-1815-	1.419,00₺	S-1855-	1.588,00₺	330 x 510 x 1550-1700	400	1	0,124	22,000	24,850
S-1816-	1.419,00₺	S-1856-	1.628,00₺	380 x 510 x 1550-1700	450	1	0,124	23,000	25,950
S-1817-	1.419,00₺	S-1857-	1.662,00₺	430 x 510 x 1550-1700	500	1	0,124	24,000	27,050

6 Sepet | 6 Baskets

Renk Seçenekleri
Color OptionsS-XXXX-C
CHROMES-XXXX-A
ANTHRACITE

Ürün Kodu				W x D x H (mm)	C (mm)	Koli	Hacim (m ³)	Ağırlık kg.	
Tel	Ahşap	Ahşap	Ahşap					Tel	Ahşap
S-1819-	1.489,00₺	S-1859-	1.638,00₺	230 x 510 x 1700-1850	300	1	0,147	23,500	25,220
S-1820-	1.489,00₺	S-1860-	1.675,00₺	280 x 510 x 1700-1850	350	1	0,147	24,500	26,560
S-1821-	1.489,00₺	S-1861-	1.712,00₺	330 x 510 x 1700-1850	400	1	0,147	25,500	27,900
S-1822-	1.489,00₺	S-1862-	1.750,00₺	380 x 510 x 1700-1850	450	1	0,147	26,500	28,180
S-1823-	1.489,00₺	S-1863-	1.785,00₺	430 x 510 x 1700-1850	500	1	0,147	27,500	30,420

6 Sepet | 6 Baskets

Renk Seçenekleri
Color OptionsS-XXXX-C
CHROMES-XXXX-A
ANTHRACITE

Ürün Kodu				W x D x H (mm)	C (mm)	Koli	Hacim (m ³)	Ağırlık kg.	
Tel	Fiyat	Ahşap	Fiyat					Tel	Ahşap
S-1825-	1.563,00₺	S-1865-	1.662,00₺	230 x 510 x 1850-2000	300	1	0,147	24,000	25,420
S-1826-	1.563,00₺	S-1866-	1.701,00₺	280 x 510 x 1850-2000	350	1	0,147	25,000	26,760
S-1827-	1.563,00₺	S-1867-	1.738,00₺	330 x 510 x 1850-2000	400	1	0,147	26,000	28,100
S-1828-	1.563,00₺	S-1868-	1.774,00₺	380 x 510 x 1850-2000	450	1	0,147	27,000	29,380
S-1829-	1.563,00₺	S-1869-	1.809,00₺	430 x 510 x 1850-2000	500	1	0,147	28,000	30,720

Teleskopik Kiler Bilyalı Raylı Sepetleri
Telescopic Larder Ballbearing BasketsRenk Seçenekleri
Color OptionsS-XXXX-C
CHROMES-XXXX-A
ANTHRACITE

Ürün Kodu				W x D x H (mm)	C (mm)	Koli	Hacim (m ³)	Ağırlık kg.	
Tel	Fiyat	Ahşap	Fiyat					Tel	Ahşap
S-1831-	93,00₺	S-1871-	115,00₺	230 x 445 x 83	300	10	0,097	18,500	19,700
S-1832-	93,00₺	S-1872-	125,00₺	280 x 445 x 83	350	10	0,117	20,000	21,600
S-1833-	93,00₺	S-1873-	133,00₺	330 x 445 x 83	400	10	0,138	21,500	23,500
S-1834-	98,00₺	S-1874-	145,00₺	380 x 445 x 83	450	10	0,158	23,500	25,800
S-1835-	104,00₺	S-1875-	154,00₺	430 x 445 x 83	500	10	0,178	25,500	27,700
S-1836-	109,00₺	S-1876-	164,00₺	480 x 440 x 83	550	10	0,199	27,000	29,400





4 Sepet | 4 Baskets

Renk Seçenekleri
Color Options S-XXXX-C
CHROME

Ürün Kodu				W x D x H (mm)	C (mm)	Koli	Hacim (m³)	Ağırlık kg.	
Tel	Fiyat	Ahşap	Fiyat					Tel	Ahşap
S-1420-	4.902,00₺	S-1720-	5.161,00₺	280 x 510 x 1250-1400	350	1	0,094	24,500	25,840
S-1421-	4.902,00₺	S-1721-	5.261,00₺	330 x 510 x 1250-1400	400	1	0,094	25,000	26,700
S-1422-	4.902,00₺	S-1722-	5.339,00₺	380 x 510 x 1250-1400	450	1	0,094	25,500	27,520
S-1423-	4.902,00₺	S-1723-	5.397,00₺	430 x 510 x 1250-1400	500	1	0,094	26,000	28,380

5 Sepet | 5 Baskets

Renk Seçenekleri
Color Options S-XXXX-C
CHROME

Ürün Kodu				W x D x H (mm)	C (mm)	Koli	Hacim (m³)	Ağırlık kg.	
Tel	Fiyat	Ahşap	Fiyat					Tel	Ahşap
S-1426-	5.010,00₺	S-1726-	5.318,00₺	280 x 510 x 1400-1550	350	1	0,124	26,000	28,900
S-1427-	5.010,00₺	S-1727-	5.397,00₺	330 x 510 x 1400-1550	400	1	0,124	27,000	30,000
S-1428-	5.010,00₺	S-1728-	5.478,00₺	380 x 510 x 1400-1550	450	1	0,124	28,000	31,050
S-1429-	5.010,00₺	S-1729-	5.519,00₺	430 x 510 x 1400-1550	500	1	0,124	29,000	32,200

5 Sepet | 5 Baskets

Renk Seçenekleri
Color Options S-XXXX-C
CHROME

Ürün Kodu				W x D x H (mm)	C (mm)	Koli	Hacim (m³)	Ağırlık kg.	
Tel	Ahşap	Ahşap	Ahşap					Tel	Ahşap
S-1432-	5.122,00₺	S-1732-	5.397,00₺	280 x 510 x 1550-1700	350	1	0,124	27,500	29,050
S-1433-	5.122,00₺	S-1733-	5.478,00₺	330 x 510 x 1550-1700	400	1	0,124	28,500	30,200
S-1434-	5.122,00₺	S-1734-	5.557,00₺	380 x 510 x 1550-1700	450	1	0,124	29,500	31,300
S-1435-	5.122,00₺	S-1735-	5.635,00₺	430 x 510 x 1550-1700	500	1	0,124	30,500	32,350

6 Sepet | 6 Baskets

Renk Seçenekleri
Color Options S-XXXX-C
CHROME

Ürün Kodu				W x D x H (mm)	C (mm)	Koli	Hacim (m³)	Ağırlık kg.	
Tel	Fiyat	Ahşap	Fiyat					Tel	Ahşap
S-1438-	5.231,00₺	S-1738-	5.519,00₺	280 x 510 x 1700-1850	350	1	0,147	29,500	31,910
S-1439-	5.231,00₺	S-1739-	5.635,00₺	330 x 510 x 1700-1850	400	1	0,147	30,500	33,250
S-1440-	5.231,00₺	S-1740-	5.678,00₺	380 x 510 x 1700-1850	450	1	0,147	31,500	34,530
S-1441-	5.231,00₺	S-1741-	5.755,00₺	430 x 510 x 1700-1850	500	1	0,147	32,500	35,870

6 Sepet | 6 Baskets

Renk Seçenekleri
Color Options S-XXXX-C
CHROME

Ürün Kodu				W x D x H (mm)	C (mm)	Koli	Hacim (m³)	Ağırlık kg.	
Tel	Fiyat	Ahşap	Fiyat					Tel	Ahşap
S-1444-	5.340,00₺	S-1744-	5.557,00₺	280 x 510 x 1850-2000	350	1	0,147	30,000	32,110
S-1445-	5.340,00₺	S-1745-	5.635,00₺	330 x 510 x 1850-2000	400	1	0,147	31,000	33,450
S-1446-	5.340,00₺	S-1746-	5.717,00₺	380 x 510 x 1850-2000	450	1	0,147	32,000	34,730
S-1447-	5.340,00₺	S-1747-	5.953,00₺	430 x 510 x 1850-2000	500	1	0,147	33,000	36,070

Döner Kiler - Frenli Sepetleri

Turning Larder Soft Closing Baskets

Renk Seçenekleri
Color Options S-XXXX-C
CHROME

Ürün Kodu				W x D x H (mm)	C (mm)	Koli	Hacim (m³)	Ağırlık kg.	
Tel	Ahşap	Ahşap	Ahşap					Tel	Ahşap
S-1362-	156,00₺	S-1662-	178,00₺	280 x 445 x 83	350	10	0,117	20,000	21,600
S-1363-	156,00₺	S-1663-	187,00₺	330 x 445 x 83	400	10	0,138	21,500	23,500
S-1364-	163,00₺	S-1664-	202,00₺	380 x 445 x 83	450	10	0,158	23,500	25,800
S-1365-	163,00₺	S-1665-	212,00₺	430 x 445 x 83	500	10	0,178	25,500	27,700

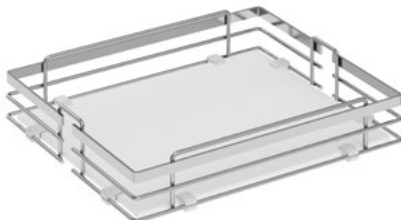



Gövde / Main

50

Kapak / Lid

20

Renk Seçenekleri
Color OptionsS-XXXX-C
CHROMES-XXXX-A
ANTHRACITE

Ürün Kodu				Sepet	W x D x H (mm)	C (mm)	Koli	Hacim (m³)	Ağırlık kg.	
Tel	Fiyat	Ahşap	Fiyat						Tel	Ahşap
S-1221-	1.187,00₺	S-1241-	1.513,00₺	4	380 x 510 x 1250-1400	450	1	0,085	22,800	22,800
S-1222-	1.414,00₺	S-1242-	1.822,00₺	4	530 x 510 x 1250-1400	600	1	0,118	27,800	27,800
S-1223-	1.325,00₺	S-1243-	1.716,00₺	5	380 x 510 x 1400-1550	450	1	0,095	26,000	26,000
S-1224-	1.565,00₺	S-1244-	2.073,00₺	5	530 x 510 x 1400-1550	600	1	0,132	31,600	31,600
S-1225-	1.356,00₺	S-1245-	1.758,00₺	5	380 x 510 x 1550-1700	450	1	0,105	26,700	26,700
S-1226-	1.615,00₺	S-1246-	2.106,00₺	5	530 x 510 x 1550-1700	600	1	0,147	32,200	32,200
S-1227-	1.505,00₺	S-1247-	1.966,00₺	6	380 x 510 x 1700-1850	450	1	0,116	29,700	29,700
S-1228-	1.771,00₺	S-1248-	2.351,00₺	6	530 x 510 x 1700-1850	600	1	0,162	36,000	36,000
S-1229-	1.539,00₺	S-1249-	1.995,00₺	6	380 x 510 x 1850-2000	450	1	0,127	30,400	30,400
S-1230-	1.793,00₺	S-1250-	2.390,00₺	6	530 x 510 x 1850-2000	600	1	0,177	36,600	36,600

İkiz Kiler Küçük Sepetleri
Twin Larder Small BasketsRenk Seçenekleri
Color OptionsS-XXXX-C
CHROMES-XXXX-A
ANTHRACITE

Ürün Kodu				W x D x H (mm)	C (mm)	Koli	Hacim (m³)	Ağırlık kg.	
Tel	Fiyat	Ahşap	Fiyat					Tel	Ahşap
S-1232-	49,00₺	S-1236-	59,00₺	320 x 120 x 100	450	10	0,042	8,350	8,450
S-1234-	63,00₺	S-1238-	76,00₺	440 x 120 x 100	600	10	0,052	10,600	10,900

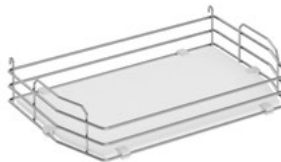
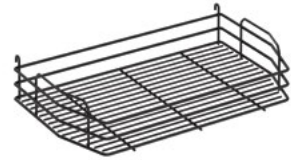
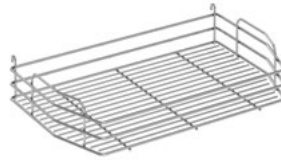
İkiz Kiler Büyük Sepetleri
Twin Larder Large BasketsRenk Seçenekleri
Color OptionsS-XXXX-C
CHROMES-XXXX-A
ANTHRACITE

Ürün Kodu				W x D x H (mm)	C (mm)	Koli	Hacim (m³)	Ağırlık kg.	
Tel	Fiyat	Ahşap	Fiyat					Tel	Ahşap
S-1233-	89,00₺	S-1237-	133,00₺	370 x 340 x 100	450	10	0,135	16,150	17,600
S-1235-	108,00₺	S-1239-	164,00₺	520 x 340 x 100	600	10	0,190	19,800	21,900



Bağımsız Çift Açılım Gizli Raylı Çekmece
Independent Drawer with Full Extension Undermount Rail

Renk Seçenekleri
Color Options

S-XXXX-C
CHROME

S-XXXX-A
ANTHRACITE

Ürün Kodu	W x D x H (mm)	C (mm)	Koli	Hacim (m ³)	Ağırlık kg.	Fiyat
S-2331-	310 - 330 x 482 x 145	350	1	0,017	4,000	365,00₺
S-2332-	360 - 380 x 482 x 145	400	1	0,020	4,200	371,00₺
S-2333-	410 - 430 x 482 x 145	450	1	0,023	4,350	379,00₺
S-2334-	460 - 480 x 482 x 145	500	1	0,026	4,550	390,00₺
S-2335-	510 - 530 x 482 x 145	550	1	0,029	4,750	396,00₺
S-2336-	560 - 580 x 482 x 145	600	1	0,032	4,950	411,00₺
S-2337-	660 - 680 x 482 x 145	700	1	0,056	5,700	440,00₺
S-2338-	760 - 780 x 482 x 145	800	1	0,065	6,200	467,00₺
S-2339-	860 - 880 x 482 x 145	900	1	0,073	6,700	485,00₺



Ahşap Tablalı Bağımsız Çift Açılım Gizli Raylı Çekmece
Independent Drawer with Wooden Bottom and Full Extension Undermount Rail

Renk Seçenekleri
Color Options

S-XXXX-C
CHROME

S-XXXX-A
ANTHRACITE

Ürün Kodu	W x D x H (mm)	C (mm)	Koli	Hacim (m ³)	Ağırlık kg.	Fiyat
S-2611-	310 - 330 x 490 x 160	350	1	0,019	4,000	577,00₺
S-2612-	360 - 380 x 490 x 160	400	1	0,022	4,200	601,00₺
S-2613-	410 - 430 x 490 x 160	450	1	0,025	4,350	623,00₺
S-2614-	460 - 480 x 490 x 160	500	1	0,028	4,550	647,00₺
S-2615-	510 - 530 x 490 x 160	550	1	0,031	4,750	682,00₺
S-2616-	560 - 580 x 490 x 160	600	1	0,034	4,950	707,00₺
S-2617-	660 - 680 x 490 x 160	700	1	0,037	5,700	751,00₺
S-2618-	760 - 780 x 490 x 160	800	1	0,043	6,200	778,00₺
S-2619-	860 - 880 x 490 x 160	900	1	0,049	6,700	817,00₺



Kapağa Monte Çift Açılım Gizli Raylı Çekmece
Drawer with Full Extension Undermount Rail Mounted To Lid

Renk Seçenekleri
Color Options

S-XXXX-C
CHROME

S-XXXX-A
ANTHRACITE

Ürün Kodu	W x D x H (mm)	C (mm)	Koli	Hacim (m ³)	Ağırlık kg.	Fiyat
S-2341-	310 - 330 x 500 x 160	350	1	0,017	4,300	428,00₺
S-2342-	360 - 380 x 500 x 160	400	1	0,020	4,600	438,00₺
S-2343-	410 - 430 x 500 x 160	450	1	0,023	4,650	443,00₺
S-2344-	460 - 480 x 500 x 160	500	1	0,026	4,950	456,00₺
S-2345-	510 - 530 x 500 x 160	550	1	0,029	5,500	462,00₺
S-2346-	560 - 580 x 500 x 160	600	1	0,032	5,900	476,00₺
S-2347-	660 - 680 x 500 x 160	700	1	0,056	6,110	506,00₺
S-2348-	760 - 780 x 500 x 160	800	1	0,065	6,600	530,00₺
S-2349-	860 - 880 x 500 x 160	900	1	0,073	7,500	552,00₺



Ahşap Tablalı Kapağa Monte Çift Açılım Gizli Raylı Çekmece
Drawer with Wooden Bottom and Full Extension Undermount Rail Mounted to Lid

Renk Seçenekleri
Color Options

S-XXXX-C
CHROME

S-XXXX-A
ANTHRACITE

Ürün Kodu	W x D x H (mm)	C (mm)	Koli	Hacim (m ³)	Ağırlık kg.	Fiyat
S-2621-	310 - 330 x 500 x 210	350	1	0,017	4,300	634,00₺
S-2622-	360 - 360 x 500 x 210	400	1	0,020	4,600	653,00₺
S-2623-	410 - 430 x 500 x 210	450	1	0,023	4,650	687,00₺
S-2624-	460 - 480 x 500 x 210	500	1	0,026	4,950	708,00₺
S-2625-	510 - 530 x 500 x 210	550	1	0,029	5,500	737,00₺
S-2626-	560 - 580 x 500 x 210	600	1	0,032	5,900	758,00₺
S-2627-	660 - 680 x 500 x 210	700	1	0,056	6,110	818,00₺
S-2628-	760 - 780 x 500 x 210	800	1	0,065	6,600	862,00₺
S-2629-	860 - 880 x 500 x 210	900	1	0,073	7,500	901,00₺



Bağımsız Teleskopik Raylı Çekmece
Independent Drawer with Telescopic Rail

Renk Seçenekleri
Color Options

S-XXXX-C
CHROME

S-XXXX-A
ANTHRACITE

Ürün Kodu	W x D x H (mm)	C (mm)	Koli	Hacim (m ³)	Ağırlık kg.	Fiyat
S-2007-	312 - 316 x 500 x 130	350	1	0,023	4,170	253,00₺
S-2008-	362 - 366 x 500 x 130	400	1	0,026	4,360	263,00₺
S-2009-	412 - 416 x 500 x 130	450	1	0,029	4,550	276,00₺
S-2010-	462 - 466 x 500 x 130	500	1	0,033	4,740	288,00₺
S-2011-	512 - 516 x 500 x 130	550	1	0,037	4,930	298,00₺
S-2012-	562 - 566 x 500 x 130	600	1	0,040	5,120	317,00₺
S-2021-	662 - 666 x 500 x 130	700	1	0,056	5,760	350,00₺
S-2022-	762 - 766 x 500 x 130	800	1	0,065	6,110	366,00₺
S-2023-	862 - 866 x 500 x 130	900	1	0,073	6,460	388,00₺



Ahşap Tablalı Bağımsız Teleskopik Raylı Çekmece

Independent Drawer with Telescopic Rail and Wooden Bottom

Renk Seçenekleri
Color Options

S-XXXX-C
CHROME

S-XXXX-A
ANTHRACITE

Ürün Kodu	W x D x H (mm)	C (mm)	Koli	Hacim (m ³)	Ağırlık kg.	Fiyat
S-2307-	312 - 316 x 500 x 130	350	1	0,017	4,100	333,00₺
S-2308-	362 - 366 x 500 x 130	400	1	0,020	4,260	352,00₺
S-2309-	412 - 416 x 500 x 130	450	1	0,023	4,470	372,00₺
S-2310-	462 - 466 x 500 x 130	500	1	0,026	4,690	389,00₺
S-2311-	512 - 516 x 500 x 130	550	1	0,029	4,900	409,00₺
S-2312-	562 - 566 x 500 x 130	600	1	0,032	5,120	428,00₺
S-2321-	662 - 666 x 500 x 130	700	1	0,056	5,960	475,00₺
S-2322-	762 - 766 x 500 x 130	800	1	0,065	6,330	513,00₺
S-2323-	862 - 866 x 500 x 130	900	1	0,073	6,710	560,00₺



Kapağa Monte Teleskopik Raylı Çekmece

Drawer with Telescopic Rail Mounted to Lid

Renk Seçenekleri
Color Options

S-XXXX-C
CHROME

S-XXXX-A
ANTHRACITE

Ürün Kodu	W x D x H (mm)	C (mm)	Koli	Hacim (m ³)	Ağırlık kg.	Fiyat
S-2057-	312 - 316 x 520 x 130	350	1	0,023	4,020	315,00₺
S-2058-	362 - 366 x 520 x 130	400	1	0,026	4,210	328,00₺
S-2059-	412 - 416 x 520 x 130	450	1	0,029	4,400	337,00₺
S-2060-	462 - 466 x 520 x 130	500	1	0,033	4,590	347,00₺
S-2061-	512 - 516 x 520 x 130	550	1	0,037	4,780	359,00₺
S-2062-	562 - 566 x 520 x 130	600	1	0,040	4,970	397,00₺
S-2071-	662 - 666 x 520 x 130	700	1	0,056	6,110	406,00₺
S-2072-	762 - 766 x 520 x 130	800	1	0,065	6,460	432,00₺
S-2073-	862 - 866 x 520 x 130	900	1	0,073	6,810	454,00₺



Ahşap Tablalı Kapağa Monte Teleskopik Raylı Çekmece

Drawer with Telescopic Rail and Wooden Bottom Mounted To Lid

Renk Seçenekleri
Color Options

S-XXXX-C
CHROME

S-XXXX-A
ANTHRACITE

Ürün Kodu	W x D x H (mm)	C (mm)	Koli	Hacim (m ³)	Ağırlık kg.	Fiyat
S-2357-	312 - 316 x 520 x 130	350	1	0,017	4,450	386,00₺
S-2358-	362 - 366 x 520 x 130	400	1	0,020	4,610	403,00₺
S-2359-	412 - 416 x 520 x 130	450	1	0,023	4,970	420,00₺
S-2360-	462 - 466 x 520 x 130	500	1	0,026	5,340	437,00₺
S-2361-	512 - 516 x 520 x 130	550	1	0,029	5,700	463,00₺
S-2362-	562 - 566 x 520 x 130	600	1	0,032	6,070	485,00₺
S-2371-	662 - 666 x 520 x 130	700	1	0,056	6,310	528,00₺
S-2372-	762 - 766 x 520 x 130	800	1	0,065	6,680	573,00₺
S-2373-	862 - 866 x 520 x 130	900	1	0,073	7,060	606,00₺



Bağımsız Evye Altı Çift Açılım Gizli Raylı Çekmece

Independent Under-Sink Drawer with Full Extension Undermount Rail

Renk Seçenekleri
Color Options

S-XXXX-C
CHROME

S-XXXX-A
ANTHRACITE

Ürün Kodu	W x D x H (mm)	A	B	C (mm)	Koli	Hacim (m ³)	Ağırlık kg.	Fiyat
S-2351-	760 - 780 x 482 x 145	525	300	800	1	0,065	6,050	557,00₺
S-2352-	860 - 880 x 482 x 145	625	300	900	1	0,073	6,600	575,00₺



Kapağa Monte Evye Altı Çift Açılım Gizli Raylı Çekmece

Under-Sink Drawer with Full Extension Undermount Rail Mounted To Lid

Renk Seçenekleri
Color Options

S-XXXX-C
CHROME

S-XXXX-A
ANTHRACITE

Ürün Kodu	W x D x H (mm)	A	B	C (mm)	Koli	Hacim (m ³)	Ağırlık kg.	Fiyat
S-2353-	760 - 780 x 500 x 160	525	300	800	1	0,065	6,320	623,00₺
S-2354-	860 - 880 x 500 x 160	625	300	900	1	0,073	6,800	645,00₺



Bağımsız Alüminyum Eveye Altı Çekmece
Aluminium Independent Under-Sink Drawer

Renk Seçenekleri
Color Options **S-XXXX-G**
GREY

Ürün Kodu	W x D x H (mm)	A	B	C (mm)	Koli	Hacim (m³)	Ağırlık kg.	Fiyat
S-2741-	764 x 500 x 150	530	310	800	1	0,065	5,720	650,00₺
S-2742-	864 x 500 x 150	530	310	900	1	0,073	6,120	665,00₺



Kapağa Monte Alüminyum Eveye Altı Çekmece
Aluminium Under-Sink Drawer Mounted To Lid

Renk Seçenekleri
Color Options **S-XXXX-G**
GREY

Ürün Kodu	W x D x H (mm)	A	B	C (mm)	Koli	Hacim (m³)	Ağırlık kg.	Fiyat
S-2751-	764 x 500 x 150	530	310	800	1	0,065	5,800	658,00₺
S-2752-	864 x 500 x 150	530	310	900	1	0,073	6,300	676,00₺



Bağımsız Teleskopik Raylı Tabaklık
Plate Holder with Telescopic Rail

Renk Seçenekleri
Color Options **S-XXXX-C**
CHROME **S-XXXX-A**
ANTHRACITE

Ürün Kodu	W x D x H (mm)	C (mm)	Koli	Hacim (m³)	Ağırlık kg.	Fiyat
S-2232-	560 x 500 x 80	600	1	0,029	4,500	292,00₺



Kapağa Monte Teleskopik Raylı Tabaklık
Plate Holder with Telescopic Rail Mounted To Lid

Renk Seçenekleri
Color Options **S-XXXX-C**
CHROME **S-XXXX-A**
ANTHRACITE

Ürün Kodu	W x D x H (mm)	C (mm)	Koli	Hacim (m³)	Ağırlık kg.	Fiyat
S-2233-	560 x 520 x 130	600	1	0,029	4,900	327,00₺



Kapağa Monte Çift Açılım Gizli Raylı Tepsili Tabaklık - Bardaklık
Plate-Glass Shelf with Tray, Mounted to Lid and Full Extension Undermount Rail

Renk Seçenekleri
Color Options **S-XXXX-C**
CHROME **S-XXXX-A**
ANTHRACITE

Ürün Kodu	W x D x H (mm)	C (mm)	Koli	Hacim (m³)	Ağırlık kg.	Ağırlık kg.
S-2031-	560 - 580 x 520 x 185	600	1	0,045	5,900	601,00₺
S-2032-	660 - 680 x 520 x 185	700	1	0,053	6,110	647,00₺
S-2033-	760 - 780 x 520 x 185	800	1	0,061	6,600	693,00₺
S-2034-	860 - 880 x 520 x 185	900	1	0,069	7,500	740,00₺



SOFT CLOSING 70

Lüks TezgaH Altı 2 Sepetli Şişelikli Ünite

Luxury Under-Workbench Unit with 2 Baskets And Bottle Division

Renk Seçenekleri
Color Options

S-XXXX-C
CHROME

S-XXXX-A
ANTHRACITE

Ürün Kodu	W x D x H (mm)	C (mm)	Koli	Hacim (m ³)	Ağırlık kg.	Fiyat
S-2170-	220 x 460 x 540	300	1	0,029	6,250	713,00₺
S-2171-	270 x 460 x 540	350	1	0,029	6,400	727,00₺
S-2172-	320 x 460 x 540	400	1	0,029	6,600	739,00₺
S-2173-	370 x 460 x 540	450	1	0,029	6,800	753,00₺
S-2174-	420 x 460 x 540	500	1	0,029	7,000	766,00₺
S-2175-	470 x 460 x 540	550	1	0,029	7,200	778,00₺
S-2176-	520 x 460 x 540	600	1	0,029	7,350	792,00₺



SOFT CLOSING 30

TezgaH Altı 2 Sepetli Şişelikli Ünite

Under-Workbench Unit with 2 Baskets and Bottle Division

Renk Seçenekleri
Color Options

S-XXXX-C
CHROME

S-XXXX-A
ANTHRACITE

Ürün Kodu	W x D x H (mm)	C (mm)	Koli	Hacim (m ³)	Ağırlık kg.	Fiyat
S-2100-	210 x 500 x 520	300	1	0,029	6,250	456,00₺
S-2101-	260 x 500 x 520	350	1	0,029	6,400	462,00₺
S-2102-	310 x 500 x 520	400	1	0,029	6,600	465,00₺
S-2103-	360 x 500 x 520	450	1	0,029	6,800	476,00₺
S-2104-	410 x 500 x 520	500	1	0,029	7,000	491,00₺
S-2105-	460 x 500 x 520	550	1	0,029	7,200	500,00₺
S-2106-	510 x 500 x 520	600	1	0,029	7,350	511,00₺



SOFT CLOSING 30

TezgaH Altı 3 Sepetli Şişelik Ünite

Under-Workbench Unit with 3 Baskets and Bottle Division

Renk Seçenekleri
Color Options

S-XXXX-C
CHROME

S-XXXX-A
ANTHRACITE

Ürün Kodu	W x D x H (mm)	C (mm)	Koli	Hacim (m ³)	Ağırlık kg.	Fiyat
S-2120-	210 x 500 x 520	300	1	0,029	6,650	496,00₺
S-2121-	260 x 500 x 520	350	1	0,029	6,950	500,00₺
S-2122-	310 x 500 x 520	400	1	0,029	7,200	503,00₺
S-2123-	360 x 500 x 520	450	1	0,029	7,400	517,00₺
S-2124-	410 x 500 x 520	500	1	0,029	7,700	543,00₺
S-2125-	460 x 500 x 520	550	1	0,029	8,100	545,00₺
S-2126-	510 x 500 x 520	600	1	0,029	8,250	570,00₺



SOFT CLOSING 30

TezgaH Altı Ekmeklik Ünitesi

Under-Workbench Unit with Bread Holder

Renk Seçenekleri
Color Options

S-XXXX-C
CHROME

S-XXXX-A
ANTHRACITE

Ürün Kodu	W x D x H (mm)	C (mm)	Koli	Hacim (m ³)	Ağırlık kg.	Fiyat
S-2151-	210 x 500 x 520	300	1	0,029	6,150	472,00₺
S-2152-	260 x 500 x 520	350	1	0,029	6,450	487,00₺
S-2153-	310 x 500 x 520	400	1	0,029	6,600	500,00₺
S-2154-	360 x 500 x 520	450	1	0,029	6,800	517,00₺



SOFT CLOSING 30

Tabak Bölmeli TezgaH Altı Ünite

Under-Workbench Unit with Plate Division

Renk Seçenekleri
Color Options

S-XXXX-C
CHROME

S-XXXX-A
ANTHRACITE

Ürün Kodu	W x D x H (mm)	C (mm)	Koli	Hacim (m ³)	Ağırlık kg.	Fiyat
S-2161-	260 x 500 x 520	350	1	0,029	6,350	419,00₺
S-2162-	310 x 500 x 520	400	1	0,029	6,450	432,00₺
S-2167-	510 x 500 x 520	600	1	0,029	7,700	521,00₺



Tabak - Bardak Bölmeli Tezgah Altı Ünite
Under-Workbench Unit with Plate - Glass Division

Renk Seçenekleri
Color Options S-XXXX-C CHROME S-XXXX-A ANTHRACITE

Ürün Kodu	W x D x H (mm)	C (mm)	Koli	Hacim (m³)	Ağırlık kg.	Fiyat
S-2163-	360 x 500 x 520	450	1	0,029	6,900	483,00₺
S-2164-	410 x 500 x 520	500	1	0,029	7,100	498,00₺
S-2165-	460 x 500 x 520	550	1	0,029	7,300	511,00₺
S-2166-	510 x 500 x 520	600	1	0,029	7,400	529,00₺



Şişe Bölmeli Alüminyum Tezgah Altı Ünite
Aluminium Under-Workbench Unit with Bottle Division

Renk Seçenekleri
Color Options S-XXXX-G GREY

Ürün Kodu	W x D x H (mm)	C (mm)	Koli	Hacim (m³)	Ağırlık kg.	Fiyat
S-2811-	240 x 500 x 520	300	1	0,068	6,600	838,00₺
S-2812-	290 x 500 x 520	350	1	0,081	7,050	876,00₺
S-2813-	340 x 500 x 520	400	1	0,094	7,280	929,00₺
S-2814-	390 x 500 x 520	450	1	0,107	7,760	983,00₺
S-2815-	440 x 500 x 520	500	1	0,120	8,050	1.020,00₺



Bıçak, Kaşık ve Şişe Bölmeli Alüminyum Tezgah Altı Ünite
Aluminium Under-Workbench Unit with Division For Knives, Spoons And Bottles

Renk Seçenekleri
Color Options S-XXXX-G GREY

Ürün Kodu	W x D x H (mm)	C (mm)	Koli	Hacim (m³)	Ağırlık kg.	Fiyat
S-2821-	240 x 500 x 520	300	1	0,068	6,940	865,00₺
S-2822-	290 x 500 x 520	350	1	0,081	7,320	898,00₺
S-2823-	340 x 500 x 520	400	1	0,094	7,560	933,00₺
S-2824-	390 x 500 x 520	450	1	0,107	8,260	984,00₺
S-2825-	440 x 500 x 520	500	1	0,120	8,400	1.054,00₺



Yandan Gizli Raylı Ünite (90 Derece)
Unit with Side Undermount Rail (90 Degrees)

Renk Seçenekleri
Color Options S-XXXX-C CHROME S-XXXX-A ANTHRACITE

Ürün Kodu				Yön Direction	W x D x H (mm)	C (mm)	Koli	Hacim (m³)	Ağırlık kg.	
Tel	Fiyat	Ahşap	Fiyat						Tel	Ahşap
S-2203-	762,00₺	S-2242-	803,00₺	Sol-Left	205 x 470 x 635	250	1	0,064	5,800	6,250
S-2204-	762,00₺	S-2243-	803,00₺	Sağ-Right	205 x 470 x 635	250	1	0,064	5,800	6,250
S-2205-	788,00₺	S-2244-	867,00₺	Sol-Left	255 x 470 x 635	300	1	0,064	6,550	6,250
S-2206-	788,00₺	S-2245-	867,00₺	Sağ-Right	255 x 470 x 635	300	1	0,064	6,550	6,250
S-2207-	754,00₺	S-2246-	804,00₺	Sol-Left	255-205-155x470x635	300	1	0,064	6,800	6,250
S-2208-	754,00₺	S-2247-	804,00₺	Sağ-Right	255-205-155x470x635	300	1	0,064	6,800	6,250
S-2791-	804,00₺	S-2795-	899,00₺	Sol-Left	305 x 470 x 635	350	1	0,064	7,300	7,300
S-2792-	804,00₺	S-2796-	899,00₺	Sağ-Right	305 x 470 x 635	350	1	0,064	7,300	7,300
S-2793-	834,00₺	S-2797-	930,00₺	Sol-Left	355 x 470 x 635	400	1	0,064	8,000	8,000
S-2794-	834,00₺	S-2798-	930,00₺	Sağ-Right	355 x 470 x 635	400	1	0,064	8,000	8,000



Yandan Gizli Raylı Ünite (45 Derece)
Unit with Side Undermount Rail (45 Degrees)

Renk Seçenekleri
Color Options S-XXXX-C CHROME S-XXXX-A ANTHRACITE

Ürün Kodu				Yön Direction	W x D x H (mm)	Koli	Hacim (m³)	Ağırlık kg.	
Tel	Fiyat	Ahşap	Fiyat					Tel	Ahşap
S-2201-	762,00₺	S-2227-	808,00₺	Sol-Left	205 x 470 x 635	1	0,064	5,100	5,550
S-2202-	762,00₺	S-2228-	808,00₺	Sağ-Right	205 x 470 x 635	1	0,064	5,100	5,550
S-2221-	780,00₺	S-2229-	869,00₺	Sol-Left	255 x 470 x 635	1	0,064	5,100	5,550
S-2222-	780,00₺	S-2230-	869,00₺	Sağ-Right	255 x 470 x 635	1	0,064	5,100	5,550



Yandan Gizli Raylı Ünite (60 Derece) Unit with Side Undermount Rail (60 Degrees)

Renk Seçenekleri
Color Options

S-XXXX-C
CHROME

S-XXXX-A
ANTHRACITE

Ürün Kodu				Yön Direction	W x D x H (mm)	Koli	Hacim (m³)	Ağırlık kg.	
Tel	Fiyat	Ahşap	Fiyat					Tel	Ahşap
S-2223-	765,00₺	S-2234-	817,00₺	Sol-Left	205 x 470 x 635	1	0,064	5,100	5,550
S-2224-	765,00₺	S-2235-	817,00₺	Sağ-Right	205 x 470 x 635	1	0,064	5,100	5,550
S-2225-	784,00₺	S-2236-	868,00₺	Sol-Left	255 x 470 x 635	1	0,064	5,100	5,550
S-2226-	784,00₺	S-2237-	868,00₺	Sağ-Right	255 x 470 x 635	1	0,064	5,100	5,550

Yandan Gizli Raylı Şişe Ünitesi Bottle Unit with Side Undermount Rail

Renk Seçenekleri
Color Options

S-XXXX-C
CHROME

S-XXXX-A
ANTHRACITE

Ürün Kodu	W x D x H (mm)	C (mm)	Direction	Koli	Hacim (m³)	Ağırlık kg.	Fiyat
S-2181-	260 x 470 x 640	400	Sol-Left	1	0,064	5,800	797,00₺
S-2182-	260 x 470 x 640	400	Sağ-Right	1	0,064	5,800	797,00₺

Yandan Gizli Raylı Tavalık Pan Holder Unit with Side Undermount Rail

Renk Seçenekleri
Color Options

S-XXXX-C
CHROME

S-XXXX-A
ANTHRACITE

Ürün Kodu	W x D x H (mm)	C (mm)	Direction	Koli	Hacim (m³)	Ağırlık kg.	Fiyat
S-2880-	310 x 475 x 640	450	Sol-Left	1	0,092	10,344	918,00₺
S-2881-	310 x 475 x 640	450	Sağ-Right	1	0,092	10,344	918,00₺

Yandan Gizli Raylı Tepsilik Tray Holder Unit with Side Undermount Rail

Renk Seçenekleri
Color Options

S-XXXX-C
CHROME

S-XXXX-A
ANTHRACITE

Ürün Kodu	W x D x H (mm)	C (mm)	Direction	Koli	Hacim (m³)	Ağırlık kg.	Fiyat
S-2898-	215 x 475 x 640	250	Sol-Left	1	0,063	9,200	827,00₺
S-2899-	215 x 475 x 640	250	Sağ-Right	1	0,063	9,200	827,00₺
S-2894-	260 x 475 x 640	300	Sol-Left	1	0,078	9,700	845,00₺
S-2895-	260 x 475 x 640	300	Sağ-Right	1	0,078	9,700	845,00₺
S-2890-	310 x 475 x 640	350	Sol-Left	1	0,092	10,244	863,00₺
S-2891-	310 x 475 x 640	350	Sağ-Right	1	0,092	10,244	863,00₺

Döner Tezgah Altı Ünite Under-Workbench Rotating Unit

Renk Seçenekleri
Color Options

S-XXXX-C
CHROME

S-XXXX-A
ANTHRACITE

Ürün Kodu				W x D x H (mm)	C (mm)	Yön Direction	Koli	Hacim (m³)	Ağırlık kg.	
Tel	Fiyat	Ahşap	Fiyat						Tel	Ahşap
S-2185-	909,00₺	S-2187-	1.039,00₺	455 x 495 x 655	500	Sol-Left	1	0,073	12,200	12,700
S-2186-	909,00₺	S-2188-	1.039,00₺	455 x 495 x 655	500	Sağ-Right	1	0,073	12,200	12,700



Plastik Kaşıklik
Plastic Spoon Holder

Renk Seçenekleri
Color Options **S-XXXX-G**
GREY

Ürün Kodu	W (mm)	D (mm)	H (mm)	C (mm)	Koli	Hacim (m³)	Ağırlık kg.	Fiyat
S-2281-	240 - 210	490-410	55	300	15	0,073	6,000	26,00₺
S-2282-	290 - 250	490-410	55	350	15	0,087	7,900	30,00₺
S-2293-	940 - 860	490-410	55	1000	15	0,311	22,290	107,00₺
S-2292-	1040 - 960	490-410	55	1100	15	0,343	24,980	116,00₺

Renk Seçenekleri
Color Options **S-XXXX-G**
GREY **S-XXXX-W**
WHITE **S-XXXX-A**
ANTHRACITE

Ürün Kodu	W (mm)	D (mm)	H (mm)	C (mm)	Koli	Hacim (m³)	Ağırlık kg.	Fiyat
S-2283-	340 - 290	490-410	55	400	15	0,102	8,560	34,00₺
S-2284-	390 - 330	490-410	55	450	15	0,125	10,170	36,00₺
S-2285-	440 - 380	490-410	55	500	15	0,133	10,280	41,00₺
S-2286-	490 - 430	490-410	55	550	15	0,172	11,620	45,00₺
S-2287-	540 - 480	490-410	55	600	15	0,172	13,680	46,00₺
S-2288-	640 - 590	490-410	55	700	15	0,250	15,200	56,00₺
S-2289-	740 - 690	490-410	55	800	15	0,285	17,600	70,00₺
S-2290-	840 - 780	490-410	55	900	15	0,301	20,040	79,00₺



Plastik Kepçelik
Plastic Ladle Holder

Renk Seçenekleri
Color Options **S-XXXX-G**
GREY

Ürün Kodu	W (mm)	D (mm)	H (mm)	C (mm)	Koli	Hacim (m³)	Ağırlık kg.	Fiyat
S-2686-	490 - 430	490-410	55	550	15	0,052	11,250	66,00₺
S-2687-	540 - 480	490-410	55	600	15	0,057	11,850	76,00₺
S-2688-	640 - 590	490-410	55	700	15	0,067	14,100	84,00₺
S-2689-	740 - 690	490-410	55	800	15	0,078	16,500	96,00₺
S-2690-	840 - 780	490-410	55	900	15	0,088	18,750	112,00₺



Gizli Raylı Ahşap Tablı Kepçelik
Pull-Out Utensil Holder

Renk Seçenekleri
Color Options **S-XXXX-C**
CHROME **S-XXXX-A**
ANTHRACITE

Ürün Kodu	W x D x H (mm)	C (mm)	Direction	Koli	Hacim (m³)	Ağırlık kg.	Fiyat
S-2651-	205 x 475 x 420	250	Sol-Left	1	0,040	6,500	857,00₺
S-2652-	205 x 475 x 420	250	Sağ-Right	1	0,040	6,500	857,00₺



Kaymaz Yüzeyle Ahşap Tablı Lamalı Şişelik - Çift Açılım
Flat Wire Bottle Holder with Anti-Slip Wooden Bottom and Full Extension Slide

Renk Seçenekleri
Color Options **S-XXXX-C**
CHROME **S-XXXX-A**
ANTHRACITE

Ürün Kodu	W x D x H (mm)	C (mm)	Direction	Koli	Hacim (m³)	Ağırlık kg.	Fiyat
S-2661-	108 x 475 x 556	150	Sağ-Right	1	0,039	6,200	901,00₺
S-2662-	108 x 475 x 556	150	Sol-Left	1	0,039	6,200	901,00₺



Çift Açılım Gizli Raylı Ahşap Tabanlı Mini Şişelik

Mini Bottle Holder with Full Extension Undermount Rail and Wooden Baskets

Renk Seçenekleri
Color Options

S-XXXX-C
CHROME

S-XXXX-A
ANTHRACITE

Ürün Kodu	W x D x H (mm)	C (mm)	Direction	Koli	Hacim (m ³)	Ağırlık kg.	Fiyat
S-2910-	106 x 280 x 520	150	Sağ-Right	1	0,016	2,200	475,00₺
S-2911-	106 x 280 x 520	150	Sol-Left	1	0,016	2,200	475,00₺

Çift Açılım Gizli Raylı 3 Sepetli Ahşap Tabanlı Mini Şişelik

Mini Bottle Holder with Full Extension Undermount Rail and 3 Wooden Baskets

Renk Seçenekleri
Color Options

S-XXXX-C
CHROME

S-XXXX-A
ANTHRACITE

Ürün Kodu	W x D x H (mm)	C (mm)	Direction	Koli	Hacim (m ³)	Ağırlık kg.	Fiyat
S-2912-	106 x 280 x 820	150	Sağ-Right	1	0,021	3,150	548,00₺
S-2913-	106 x 280 x 820	150	Sol-Left	1	0,021	3,150	548,00₺

Çift Açılım Gizli Raylı 3 Sepetli Ahşap Tabanlı Şişelik

Bottle Holder with Full Extension Undermount Rail and 3 Wooden Baskets

Renk Seçenekleri
Color Options

S-XXXX-C
CHROME

S-XXXX-A
ANTHRACITE

Ürün Kodu	W x D x H (mm)	C (mm)	Direction	Koli	Hacim (m ³)	Ağırlık kg.	Fiyat
S-2916-	106 x 450 x 920	150	Sağ-Right	1	0,046	6,100	695,00₺
S-2917-	106 x 450 x 920	150	Sol-Left	1	0,046	6,100	695,00₺
S-2926-	155 x 450 x 920	200	Sağ-Right	1	0,070	6,500	744,00₺
S-2927-	155 x 450 x 920	200	Sol-Left	1	0,070	6,500	744,00₺

Çift Açılım Gizli Raylı 4 Sepetli Ahşap Tabanlı Şişelik

Bottle Holder with Full Extension Undermount Rail and 4 Wooden Baskets

Renk Seçenekleri
Color Options

S-XXXX-C
CHROME

S-XXXX-A
ANTHRACITE

Ürün Kodu	W x D x H (mm)	C (mm)	Direction	Koli	Hacim (m ³)	Ağırlık kg.	Fiyat
S-2918-	106 x 450 x 1650	150	Sağ-Right	1	0,082	8,300	981,00₺
S-2919-	106 x 450 x 1650	150	Sol-Left	1	0,082	8,300	981,00₺
S-2928-	155 x 450 x 1650	200	Sağ-Right	1	0,126	10,000	1.232,00₺
S-2929-	155 x 450 x 1650	200	Sol-Left	1	0,126	10,000	1.232,00₺



Gizli Raylı Şişelik (Tek Açılım)

Bottle Holder with Undermount Rail (Single Extension)

Renk Seçenekleri
Color Options

S-XXXX-C
CHROME S-XXXX-A
ANTHRACITE

Ürün Kodu				Yön Direction	W x D x H (mm)	C (mm)	Koli	Hacim (m³)	Ağırlık kg.	
Tel	Fiyat	Ahşap	Fiyat						Tel	Ahşap
S-2421-	299,00₺	S-2475-	378,00₺	Sağ-Right	106 x 475 x 495	150	1	0,026	4,215	4,365
S-2422-	299,00₺	S-2476-	378,00₺	Sol-Left	106 x 475 x 495	150	1	0,026	4,215	4,365



Gizli Raylı Şişelik (Çift Açılım)

Bottle Holder with Undermount Rail (Full Extension)

Renk Seçenekleri
Color Options

S-XXXX-C
CHROME S-XXXX-A
ANTHRACITE

Ürün Kodu				Yön Direction	W x D x H (mm)	C (mm)	Koli	Hacim (m³)	Ağırlık kg.	
Tel	Fiyat	Ahşap	Fiyat						Tel	Ahşap
S-2413-	411,00₺	S-2477-	520,00₺	Sağ-Right	106 x 475 x 495	150	1	0,026	5,190	5,340
S-2414-	411,00₺	S-2478-	520,00₺	Sol-Left	106 x 475 x 495	150	1	0,026	5,190	5,340



45 Derece Gizli Raylı Şişelik (Tek Açılım)

45 Degrees Bottle Holder with Undermount Rail (Single Extension)

Renk Seçenekleri
Color Options

S-XXXX-C
CHROME S-XXXX-A
ANTHRACITE

Ürün Kodu				Yön Direction	W x D x H (mm)	C (mm)	Koli	Hacim (m³)	Ağırlık kg.	
Tel	Fiyat	Ahşap	Fiyat						Tel	Ahşap
S-2601-	288,00₺	S-2603-	380,00₺	Sağ-Right	106 x 465 x 495	150	1	0,026	4,190	4,340
S-2602-	288,00₺	S-2604-	380,00₺	Sol-Left	106 x 465 x 495	150	1	0,026	4,190	4,340



45 Derece Gizli Raylı Şişelik (Çift Açılım)

45 Degrees Bottle Holder with Undermount Rail (Full Extension)

Renk Seçenekleri
Color Options

S-XXXX-C
CHROME S-XXXX-A
ANTHRACITE

Ürün Kodu				Yön Direction	W x D x H (mm)	C (mm)	Koli	Hacim (m³)	Ağırlık kg.	
Tel	Fiyat	Ahşap	Fiyat						Tel	Ahşap
S-2605-	417,00₺	S-2607-	529,00₺	Sağ-Right	106 x 465 x 495	150	1	0,026	4,190	4,800
S-2606-	417,00₺	S-2608-	529,00₺	Sol-Left	106 x 465 x 495	150	1	0,026	4,190	4,800



Yandan Teleskopik Raylı Şişelik

Bottle Holder with Side Telescopic Rail

Renk Seçenekleri
Color Options

S-XXXX-C
CHROME S-XXXX-A
ANTHRACITE

Ürün Kodu				W x D x H (mm)	C (mm)	Koli	Hacim (m³)	Ağırlık kg.	
Tel	Fiyat	Ahşap	Fiyat					Tel	Ahşap
S-2211-	261,00₺	S-2219-	319,00₺	108 x 470 x 470	150	1	0,026	4,550	4,700



SOFT CLOSING 30

Yandan Teleskopik Raylı Alüminyum Şişelik Aluminium Bottle Holder with Side Telescopic Rail

Renk Seçenekleri
Color Options

S-XXXX-G
GREY

Ürün Kodu	W x D x H (mm)	C (mm)	Koli	Hacim (m ³)	Ağırlık kg.	Fiyat
S-2806-	110 x 500 x 470	150	1	0,030	3,560	515,00₺



SOFT CLOSING 30

Gizli Raylı Havlu Askılı Şişelik (Tek Açılım) Bottle/Towel Holder with Undermount Rail (Single Extension)

Renk Seçenekleri
Color Options

S-XXXX-C
CHROME

S-XXXX-A
ANTHRACITE

Ürün Kodu				Yön Direction	W x D x H (mm)	C (mm)	Koli	Hacim (m ³)	Ağırlık kg.	
Tel	Fiyat	Ahşap	Fiyat						Tel	Ahşap
S-2501-	314,00₺	S-2511-	321,00₺	Sol-Left	106 x 475 x 640	150	1	0,033	4,215	4,365
S-2502-	314,00₺	S-2512-	321,00₺	Sağ-Right	106 x 475 x 640	150	1	0,033	4,215	4,365



SOFT CLOSING 30

Gizli Raylı Havlu Askılı Şişelik (Çift Açılım) Bottle/Towel Holder with Undermount Rail (Full Extension)

Renk Seçenekleri
Color Options

S-XXXX-C
CHROME

S-XXXX-A
ANTHRACITE

Ürün Kodu				Yön Direction	W x D x H (mm)	C (mm)	Koli	Hacim (m ³)	Ağırlık kg.	
Tel	Fiyat	Ahşap	Fiyat						Tel	Ahşap
S-2521-	443,00₺	S-2641-	452,00₺	Sol-Left	106 x 475 x 640	150	1	0,033	5,190	5,340
S-2522-	443,00₺	S-2642-	452,00₺	Sağ-Right	106 x 475 x 640	150	1	0,033	5,190	5,340



SOFT CLOSING 30

Gizli Raylı Havlu Askılı Deterjanlık (Tek Açılım) Detergent/Towel Holder with Undermount Rail (Single Extension)

Renk Seçenekleri
Color Options

S-XXXX-C
CHROME

S-XXXX-A
ANTHRACITE

Ürün Kodu				Yön Direction	W x D x H (mm)	C (mm)	Koli	Hacim (m ³)	Ağırlık kg.	
Tel	Fiyat	Ahşap	Fiyat						Tel	Ahşap
S-2503-	328,00₺	S-2513-	347,00₺	Sol-Left	151 x 475 x 640	200	1	0,045	4,630	4,865
S-2504-	328,00₺	S-2514-	347,00₺	Sağ-Right	151 x 475 x 640	200	1	0,045	4,630	4,865
S-2505-	345,00₺	S-2515-	378,00₺	Sol-Left	203 x 475 x 640	250	1	0,062	5,085	5,350
S-2506-	345,00₺	S-2516-	378,00₺	Sağ-Right	203 x 475 x 640	250	1	0,062	5,085	5,350



SOFT CLOSING 30

Gizli Raylı Havlu Askılı Deterjanlık (Çift Açılım) Detergent/Towel Holder with Undermount Rail (Full Extension)

Renk Seçenekleri
Color Options

S-XXXX-C
CHROME

S-XXXX-A
ANTHRACITE

Ürün Kodu				Yön Direction	W x D x H (mm)	C (mm)	Koli	Hacim (m ³)	Ağırlık kg.	
Tel	Fiyat	Ahşap	Fiyat						Tel	Ahşap
S-2523-	459,00₺	S-2643-	474,00₺	Sol-Left	151 x 475 x 640	200	1	0,045	5,610	5,840
S-2524-	459,00₺	S-2644-	474,00₺	Sağ-Right	151 x 475 x 640	200	1	0,045	5,610	5,840
S-2525-	480,00₺	S-2645-	509,00₺	Sol-Left	203 x 475 x 640	250	1	0,062	6,060	6,325
S-2526-	480,00₺	S-2646-	509,00₺	Sağ-Right	203 x 475 x 640	250	1	0,062	6,060	6,325



Gizli Raylı Deterjanlık (Tek Açılım)
Detergent Holder with Undermount Rail (Single Extension)

Renk Seçenekleri
Color Options

S-XXXX-C
CHROME

S-XXXX-A
ANTHRACITE

Ürün Kodu				Yön Direction	W x D x H (mm)	C (mm)	Koli	Hacim (m³)	Ağırlık kg.	
Tel	Fiyat	Ahşap	Fiyat						Tel	Ahşap
S-2423-	313,00₺	S-2485-	422,00₺	Sağ-Right	151 x 475 x 495	200	1	0,040	4,630	4,865
S-2426-	313,00₺	S-2484-	422,00₺	Sol-Left	151 x 475 x 495	200	1	0,040	4,630	4,865
S-2424-	332,00₺	S-2487-	460,00₺	Sağ-Right	203 x 475 x 495	250	1	0,058	5,085	5,350
S-2427-	332,00₺	S-2486-	460,00₺	Sol-Left	203 x 475 x 495	250	1	0,058	5,085	5,350
S-2425-	332,00₺	S-2489-	460,00₺	Sağ-Right	203/151 x 475 x 495	250	1	0,058	5,170	5,470
S-2428-	332,00₺	S-2488-	460,00₺	Sol-Left	203/151 x 475 x 495	250	1	0,058	5,170	5,470



Gizli Raylı Deterjanlık (Çift Açılım)
Detergent Holder with Undermount Rail (Full Extension)

Renk Seçenekleri
Color Options

S-XXXX-C
CHROME

S-XXXX-A
ANTHRACITE

Ürün Kodu				Yön Direction	W x D x H (mm)	C (mm)	Koli	Hacim (m³)	Ağırlık kg.	
Tel	Fiyat	Ahşap	Fiyat						Tel	Ahşap
S-2441-	438,00₺	S-2491-	563,00₺	Sol-Left	151 x 475 x 495	200	1	0,040	5,610	5,840
S-2442-	438,00₺	S-2492-	563,00₺	Sağ-Right	151 x 475 x 495	200	1	0,040	5,610	5,840
S-2443-	456,00₺	S-2493-	604,00₺	Sol-Left	203 x 475 x 495	250	1	0,058	6,060	6,325
S-2444-	456,00₺	S-2494-	604,00₺	Sağ-Right	203 x 475 x 495	250	1	0,058	6,060	6,325
S-2445-	456,00₺	S-2495-	604,00₺	Sol-Left	203/151 x 475 x 495	250	1	0,058	6,150	6,450
S-2446-	456,00₺	S-2496-	604,00₺	Sağ-Right	203/151 x 475 x 495	250	1	0,058	6,150	6,450



Yandan Teleskopik Raylı Deterjanlık
Detergent Holder with Side Telescopic Rail

Renk Seçenekleri
Color Options

S-XXXX-C
CHROME

S-XXXX-A
ANTHRACITE

Ürün Kodu				W x D x H (mm)	C (mm)	Koli	Hacim (m³)	Ağırlık kg.	
Tel	Fiyat	Ahşap	Fiyat					Tel	Ahşap
S-2213-	286,00₺	S-2481-	348,00₺	153 x 470 x 470	200	1	0,040	4,720	5,220
S-2214-	296,00₺	S-2482-	389,00₺	205 x 470 x 470	250	1	0,058	5,600	5,725
S-2215-	307,00₺	S-2483-	394,00₺	205/153 x 470 x 470	250	1	0,058	5,320	5,845



Altın Raylı Alüminyum Deterjanlık
Aluminium Detergent Holder with Bottom Rail

Renk Seçenekleri
Color Options

S-XXXX-G
GREY

Ürün Kodu	W x D x H (mm)	C (mm)	Koli	Hacim (m³)	Ağırlık kg.	Fiyat
S-2802-	150 x 500 x 520	200	1	0,043	4,900	567,00₺
S-2803-	200 x 500 x 520	250	1	0,057	5,340	604,00₺



Taşınabilir Sepetli Deterjanlık
Detergent Holder with Portable Basket

Renk Seçenekleri
Color Options

S-XXXX-C
CHROME

S-XXXX-A
ANTHRACITE

Ürün Kodu	W x D x H (mm)	C (mm)	Koli	Hacim (m³)	Ağırlık kg.	Fiyat
S-2498-	280 x 460 x 405	350	1	0,035	5,300	363,00₺



Teleskopik Raylı Taşıyıcı Ünite Carrying Unit with Telescopic Rail

Renk Seçenekleri
Color Options

S-XXXX-G
GREY

S-XXXX-A
ANTHRACITE

Ürün Kodu	W x D x H (mm)	C (mm)		Koli	Hacim (m³)	Ağırlık kg.	Fiyat
		Automatic	Manual				
S-2393-	260 x 430 x 245	400	350	1	0,028	3,400	230,00₺



Çekmece İçi Çöp Kovası (Manuel) Inner Drawer Waste Bin (Manual)

Renk Seçenekleri
Color Options

S-XXXX-G
GREY

S-XXXX-A
ANTHRACITE

Ürün Kodu	W (mm)	D (mm)	H (mm)	C (mm)	Lt.	Koli	Hacim (m³)	Ağırlık kg.	Fiyat
S-2531-	540-470	490-415	235	600	12+12+1+1	1	0,074	3,272	234,00₺
S-2532-	540-470	490-415	305	600	16+16+1+1	1	0,074	3,272	242,00₺
S-2541-	640-570	490-415	235	700	12+12+1+1	1	0,088	3,480	267,00₺
S-2542-	640-570	490-415	305	700	16+16+1+1	1	0,088	3,480	273,00₺
S-2551-	740-705	490-415	235	800	12+12+12+1+1+1	1	0,101	4,432	300,00₺
S-2552-	740-705	490-415	305	800	16+16+16+1+1+1	1	0,101	4,432	305,00₺
S-2561-	840-800	490-415	235	900	12+12+12+1+1+1	1	0,114	4,682	333,00₺
S-2562-	840-800	490-415	305	900	16+16+16+1+1+1	1	0,114	4,682	340,00₺



Çekmece İçi Çöp Kovası Taşınabilir Sepetli (Manuel) Inner Drawer Waste Bin with Portable Basket (Manual)

Renk Seçenekleri
Color Options

S-XXXX-G
GREY

S-XXXX-A
ANTHRACITE

Ürün Kodu	W (mm)	D (mm)	H (mm)	C (mm)	Lt.	Koli	Hacim (m³)	Ağırlık kg.	Fiyat
S-2533-	540-470	490-415	235	600	12+1+1	1	0,074	3,272	250,00₺
S-2534-	540-470	490-415	305	600	16+1+1	1	0,074	3,272	257,00₺
S-2543-	640-570	490-415	235	700	12+1+1	1	0,088	3,480	282,00₺
S-2544-	640-570	490-415	305	700	16+1+1	1	0,088	3,480	290,00₺
S-2553-	740-705	490-415	235	800	12+12+1+1+1	1	0,101	4,432	315,00₺
S-2554-	740-705	490-415	305	800	16+16+1+1+1	1	0,101	4,432	333,00₺
S-2563-	840-800	490-415	235	900	12+12+1+1+1	1	0,114	4,682	347,00₺
S-2564-	840-800	490-415	305	900	16+16+1+1+1	1	0,114	4,682	354,00₺

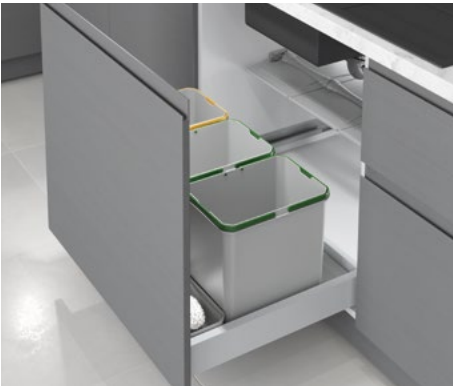

Çekmece İçi Çöp Kovası (Otomatik) Inner Drawer Waste Bin (Automatic)

Renk Seçenekleri
Color Options

S-XXXX-G
GREY

S-XXXX-A
ANTHRACITE

Ürün Kodu	W (mm)	D (mm)	H (mm)	C (mm)	Lt.	Koli	Hacim (m³)	Ağırlık kg.	Fiyat
S-2535-	540-470	490-415	265	600	12+12+1+1	1	0,074	3,272	266,00₺
S-2536-	540-470	490-415	330	600	16+16+1+1	1	0,074	3,272	273,00₺
S-2545-	640-570	490-415	265	700	12+12+1+1	1	0,088	3,480	300,00₺
S-2546-	640-570	490-415	330	700	16+16+1+1	1	0,088	3,480	305,00₺
S-2555-	740-705	490-415	265	800	12+12+12+1+1+1	1	0,101	4,432	340,00₺
S-2556-	740-705	490-415	330	800	16+16+16+1+1+1	1	0,101	4,432	347,00₺
S-2565-	840-800	490-415	265	900	12+12+12+1+1+1	1	0,114	4,682	364,00₺
S-2566-	840-800	490-415	330	900	16+16+16+1+1+1	1	0,114	4,682	372,00₺



Çekmece İçi Çöp Kovası Taşınabilir Sepetli (Otomatik) Inner Drawer Waste Bin with Portable Basket (Automatic)

Renk Seçenekleri
Color Options

S-XXXX-G
GREY

S-XXXX-A
ANTHRACITE

Ürün Kodu	W (mm)	D (mm)	H (mm)	C (mm)	Lt.	Koli	Hacim (m³)	Ağırlık kg.	Fiyat
S-2537-	540-470	490-415	265	600	12+1+1	1	0,074	3,272	282,00₺
S-2538-	540-470	490-415	330	600	16+1+1	1	0,074	3,272	290,00₺
S-2547-	640-570	490-415	265	700	12+1+1	1	0,088	3,480	315,00₺
S-2548-	640-570	490-415	330	700	16+1+1	1	0,088	3,480	321,00₺
S-2557-	740-705	490-415	265	800	12+12+1+1+1	1	0,101	4,432	354,00₺
S-2558-	740-705	490-415	330	800	16+16+1+1+1	1	0,101	4,432	364,00₺
S-2567-	840-800	490-415	265	900	12+12+1+1+1	1	0,114	4,682	382,00₺
S-2568-	840-800	490-415	330	900	16+16+1+1+1	1	0,114	4,682	388,00₺



Kapağa Monte Çöp Kovası Frenli
Waste Bin Mounted To Lid Soft Closing

Renk Seçenekleri
Color Options

S-XXXX-G
GREY

S-XXXX-A
ANTHRACITE

Ürün Kodu	W x D x H (mm)	C (mm)	Lt.	Koli	Hacim (m³)	Ağırlık kg.	Fiyat
S-2300-	364 x 470 x 435	400	35	1	0,074	9,200	833,00₺
S-2381-	364 x 470 x 380	400	12+12	1	0,050	6,650	827,00₺
S-2382-	414 x 470 x 380	450	16+16	1	0,055	7,150	849,00₺
S-2383-	464 x 470 x 380	500	16+16	1	0,060	7,650	864,00₺
S-2384-	514 x 470 x 380	550	16+16+1+1	1	0,065	8,150	902,00₺
S-2385-	564 x 470 x 380	600	16+12+12+1	1	0,070	8,650	963,00₺
S-2386-	664 x 470 x 380	700	16+16+12+12+1	1	0,119	9,150	1.257,00₺
S-2387-	764 x 470 x 380	800	16+16+16+16+1+1	1	0,136	9,650	1.344,00₺
S-2388-	864 x 470 x 380	900	16+16+16+16+12+1	1	0,154	10,150	1.436,00₺



Teleskopik Raylı Plastik Gövde Çöp Kovası 24 Lt.
Waste Bin Plastic Body with Telescopic Rail 24 Lt.

Renk Seçenekleri
Color Options

S-XXXX-G
GREY

S-XXXX-A
ANTHRACITE

Ürün Kodu	W x D x H (mm)	C (mm)		Lt.	Koli	Hacim (m³)	Ağırlık kg.	Fiyat
		Automatic	Manual					
S-2571-	260 x 440 x 400	400	350	24	1	0,047	4,600	341,00₺



Teleskopik Raylı Paslanmaz Gövde Çöp Kovası 24 Lt.
Waste Bin Stainless Steel Body with Telescopic Rail 24 Lt.

Renk Seçenekleri
Color Options

S-XXXX-G
GREY

Ürün Kodu	W x D x H (mm)	C (mm)		Lt.	Koli	Hacim (m³)	Ağırlık kg.	Fiyat
		Automatic	Manual					
S-2572-	260 x 440 x 400	400	350	24	1	0,047	5,100	424,00₺



Teleskopik Raylı Plastik Gövde Çöp Kovası 16 Lt.
Waste Bin Plastic Body with Telescopic Rail 16 Lt.

Renk Seçenekleri
Color Options

S-XXXX-G
GREY

S-XXXX-A
ANTHRACITE

Ürün Kodu	W x D x H (mm)	C (mm)		Lt.	Koli	Hacim (m³)	Ağırlık kg.	Fiyat
		Automatic	Manual					
S-2573-	260 x 440 x 300	400	350	16	1	0,034	4,000	320,00₺



Teleskopik Raylı Paslanmaz Gövde Çöp Kovası 16 Lt.
Waste Bin Stainless Steel Body with Telescopic Rail 16 Lt.

Renk Seçenekleri
Color Options

S-XXXX-G
GREY

Ürün Kodu	W x D x H (mm)	C (mm)		Lt.	Koli	Hacim (m³)	Ağırlık kg.	Fiyat
		Automatic	Manual					
S-2574-	260 x 440 x 300	400	350	16	1	0,034	4,250	386,00₺



Teleskopik Raylı Plastik Gövde Çöp Kovası 16+1 Lt.
Waste Bin Plastic Body with Telescopic Rail 16+1 Lt.

Renk Seçenekleri
Color Options

S-XXXX-G
GREY

S-XXXX-A
ANTHRACITE

Ürün Kodu	W x D x H (mm)	C (mm)		Lt.	Koli	Hacim (m ³)	Ağırlık kg.	Fiyat
		Automatic	Manual					
S-2391-	260 x 440 x 400	400	350	16+1	1	0,045	4,000	333,00₺



Teleskopik Raylı Paslanmaz Gövde Çöp Kovası 16+1 Lt.
Waste Bin Stainless Steel Body with Telescopic Rail 16+1 Lt.

Renk Seçenekleri
Color Options

S-XXXX-G
GREY

Ürün Kodu	W x D x H (mm)	C (mm)		Lt.	Koli	Hacim (m ³)	Ağırlık kg.	Fiyat
		Automatic	Manual					
S-2395-	260 x 440 x 400	400	350	16+1	1	0,045	4,350	403,00₺



Teleskopik Raylı Plastik Gövde Çöp Kovası 12+12 Lt.
Waste Bin Plastic Body with Telescopic Rail 12+12 Lt.

Renk Seçenekleri
Color Options

S-XXXX-G
GREY

S-XXXX-A
ANTHRACITE

Ürün Kodu	W x D x H (mm)	C (mm)		Lt.	Koli	Hacim (m ³)	Ağırlık kg.	Fiyat
		Automatic	Manual					
S-2392-	260 x 440 x 400	400	350	12+12	1	0,045	4,250	357,00₺



Teleskopik Raylı Paslanmaz Gövde Çöp Kovası 12+12 Lt.
Waste Bin Stainless Steel Body with Telescopic Rail 12+12 Lt.

Renk Seçenekleri
Color Options

S-XXXX-G
GREY

Ürün Kodu	W x D x H (mm)	C (mm)		Lt.	Koli	Hacim (m ³)	Ağırlık kg.	Fiyat
		Automatic	Manual					
S-2396-	260 x 440 x 400	400	350	12+12	1	0,045	4,750	425,00₺



Bağımsız Teleskopik Raylı Zemin Bağlantılı Çöp Kovası 12+12 Litre
Bottom Mounted Independent Waste Bin with Telescopic Rail 12+12 Liter

Renk Seçenekleri
Color Options

S-XXXX-G
GREY

S-XXXX-A
ANTHRACITE

Ürün Kodu	W x D x H (mm)	C (mm)	Lt.	Koli	Hacim (m ³)	Ağırlık kg.	Fiyat
S-2578-	340 x 485 x 315	400	12+12	1	0,053	5,700	404,00₺



Kapağa Monte Teleskopik Raylı Zemin Bağlantılı Çöp Kovası 12+12 Litre
Bottom Mounted Waste Bin with Telescopic Rail Mounted to Lid 12+12 Liter

Renk Seçenekleri
Color Options

S-XXXX-G
GREY

S-XXXX-A
ANTHRACITE

Ürün Kodu	W x D x H (mm)	C (mm)	Lt.	Koli	Hacim (m ³)	Ağırlık kg.	Fiyat
S-2581-	340 x 485 x 315	400	12+12	1	0,053	6,200	429,00₺



Bağımsız Teleskopik Raylı Zemin Bağlantılı Çöp Kovası 16+16 Litre
Bottom Mounted Independent Waste Bin with Telescopic Rail 16+16 Liter

Renk Seçenekleri
Color Options

S-XXXX-G
GREY

S-XXXX-A
ANTHRACITE

Ürün Kodu	W x D x H (mm)	C (mm)	Lt.	Koli	Hacim (m ³)	Ağırlık kg.	Fiyat
S-2579-	340 x 485 x 385	400	16+16	1	0,065	5,800	449,00₺



Kapağa Monte Teleskopik Raylı Zemin Bağlantılı Çöp Kovası 16+16 Litre
Bottom Mounted Waste Bin with Telescopic Rail Mounted to Lid 16+16 Liter

Renk Seçenekleri
Color Options

S-XXXX-G
GREY

S-XXXX-A
ANTHRACITE

Ürün Kodu	W x D x H (mm)	C (mm)	Lt.	Koli	Hacim (m ³)	Ağırlık kg.	Fiyat
S-2582-	340 x 485 x 385	400	16+16	1	0,065	6,300	468,00₺



Bağımsız Teleskopik Raylı Zemin Bağlantılı Çöp Kovası 35 Litre
Bottom Mounted Independent Waste Bin with Telescopic Rail 35 Liter

Renk Seçenekleri
Color Options

S-XXXX-G
GREY

S-XXXX-A
ANTHRACITE

Ürün Kodu	W x D x H (mm)	C (mm)	Lt.	Koli	Hacim (m ³)	Ağırlık kg.	Fiyat
S-2580-	300 x 477 x 487	400	35	1	0,072	5,500	360,00₺



Kapağa Monte Teleskopik Raylı Zemin Bağlantılı Çöp Kovası 35 Litre
Bottom Mounted Waste Bin with Telescopic Rail Mounted to Lid 35 Liter

Renk Seçenekleri
Color Options

S-XXXX-G
GREY

S-XXXX-A
ANTHRACITE

Ürün Kodu	W x D x H (mm)	C (mm)	Lt.	Koli	Hacim (m ³)	Ağırlık kg.	Fiyat
S-2583-	300 x 477 x 487	400	35	1	0,072	6,000	390,00₺



SOFT CLOSING 30

Bağımsız Teleskopik Raylı Zemin Bağlantılı Çöp Kovası 35 Litre
Bottom Mounted Independent Waste Bin with Telescopic Rail 35 Liter

Renk Seçenekleri
Color Options

S-XXXX-G
GREY

S-XXXX-A
ANTHRACITE

Ürün Kodu	W x D x H (mm)	C (mm)	Lt.	Koli	Hacim (m ³)	Ağırlık kg.	Fiyat
S-2590-	263 x 465 x 525	300	35	1	0,070	5,000	489,00₺



SOFT CLOSING 30

Kapağa Monte Teleskopik Raylı Zemin Bağlantılı Çöp Kovası 35 Litre
Bottom Mounted Waste Bin with Telescopic Rail Mounted to Lid 35 Liter

Renk Seçenekleri
Color Options

S-XXXX-G
GREY

S-XXXX-A
ANTHRACITE

Ürün Kodu	W x D x H (mm)	C (mm)	Lt.	Koli	Hacim (m ³)	Ağırlık kg.	Fiyat
S-2591-	263 x 475 x 525	300	35	1	0,070	5,400	568,00₺



SOFT CLOSING 30

Bağımsız Teleskopik Raylı Zemin Bağlantılı Çöp Kovası 35+35 Litre
Bottom Mounted Independent Waste Bin with Telescopic Rail 35+35 Liter

Renk Seçenekleri
Color Options

S-XXXX-G
GREY

S-XXXX-A
ANTHRACITE

Ürün Kodu	W x D x H (mm)	C (mm)	Lt.	Koli	Hacim (m ³)	Ağırlık kg.	Fiyat
S-2592-	360 x 550 x 525	400	35+35	1	0,111	6,100	621,00₺



SOFT CLOSING 30

Kapağa Monte Teleskopik Raylı Zemin Bağlantılı Çöp Kovası 35+35 Litre
Bottom Mounted Waste Bin with Telescopic Rail Mounted to Lid 35+35 Liter

Renk Seçenekleri
Color Options

S-XXXX-G
GREY

S-XXXX-A
ANTHRACITE

Ürün Kodu	W x D x H (mm)	C (mm)	Lt.	Koli	Hacim (m ³)	Ağırlık kg.	Fiyat
S-2593-	360 x 550 x 525	400	35+35	1	0,111	6,500	700,00₺



Askılı Çöp Kovası 5 Lt.
Hanging Waste Bin 5 Lt.

Renk Seçenekleri
Color Options

S-XXXX-G
GREY

S-XXXX-W
WHITE

S-XXXX-A
ANTHRACITE

Ürün Kodu	W x D x H (mm)	Lt.	Koli	Hacim (m ³)	Ağırlık kg.	Fiyat
S-2575-	250 x 195 x 180	5	12	0,009	6,000	46,00₺



Çöp Kovası Otomatik Kapak 10 Lt.
Waste Bin Automatic Cover 10 Lt.

Renk Seçenekleri
Color Options

S-XXXX-SS
STAINLESS STEEL

S-XXXX-B
BLACK

Ürün Kodu	W x D x H (mm)	Lt.	Koli	Hacim (m³)	Ağırlık kg.	Fiyat
S-2253-	355 x 300 x 380	10	12	0,310	25,430	122,00₺



Çöp Kovası 10 Lt.
Waste Bin 10 Lt.

Renk Seçenekleri
Color Options

S-XXXX-SS
STAINLESS STEEL

Ürün Kodu	W x D x H (mm)	Lt.	Koli	Hacim (m³)	Ağırlık kg.	Fiyat
S-2251-	365 x 300 x 320	10	12	0,310	25,430	122,00₺



Raylı Tüpçek
Tube Puller with Rail

Renk Seçenekleri
Color Options

S-XXXX-G
GREY

S-XXXX-A
ANTHRACITE

Ürün Kodu	W x D x H (mm)	C (mm)	Koli	Hacim (m³)	Ağırlık kg.	Fiyat
S-2241-	325 x 460 x 55	400	5	0,048	28,550	248,00₺



Alüminyum Eveye Altlığı
Aluminium Tray For Under-Sink

Renk Seçenekleri
Color Options

S-XXXX-G
GREY

Ürün Kodu	W x D x H (mm)	C (mm)	Koli	Hacim (m³)	Ağırlık kg.	Fiyat
S-2271-	464 x 475 x 95	500	10	0,032	2,900	32,00₺
S-2272-	564 x 475 x 95	600	10	0,038	3,500	35,00₺
S-2273-	664 x 475 x 95	700	10	0,045	4,500	40,00₺
S-2274-	764 x 475 x 95	800	10	0,051	4,700	45,00₺
S-2275-	864 x 475 x 95	900	10	0,058	5,250	50,00₺
S-2276-	964 x 475 x 95	1000	10	0,065	5,800	55,00₺
S-2277-	1064 x 475 x 95	1100	10	0,071	6,450	59,00₺
S-2278-	1164 x 475 x 95	1200	10	0,078	7,000	64,00₺



Kaydırmaz Çekmece Örtüsü
Skidproof Drawer Cover Roll

Renk Seçenekleri
Color Options

S-XXXX-G
GREY

S-XXXX-W
WHITE

S-XXXX-A
ANTHRACITE

Ürün Kodu	W x D x H (mm)	Koli	Hacim (m³)	Ağırlık kg.	Fiyat
S-2291-	500 x 10.000 x 1,20	1	0,014	5,400	713,00₺





Kapağa Monte Körköşe Mekanizması
Secret Corner Mechanism Mounted to Lid

Renk Seçenekleri
Color Options

S-XXXX-C
CHROME

S-XXXX-A
ANTHRACITE

Tel	Ürün Kodu			Yön Direction	W x D x H (mm)	C (mm)	Koli	Hacim (m³)	Ağırlık kg.	
	Ahşap	Ahşap	Ahşap						Tel	Ahşap
S-3001-	1.510,00₺	S-3003-	1.601,00₺	Sol-Left	860-965 x 530 x 530	450	1	0,132	23,000	24,400
S-3002-	1.510,00₺	S-3004-	1.601,00₺	Sağ-Right	860-965 x 530 x 530	450	1	0,132	23,000	24,400
S-3071-	1.522,00₺	S-3073-	1.643,00₺	Sol-Left	860-965 x 530 x 530	500	1	0,132	23,400	24,600
S-3072-	1.522,00₺	S-3074-	1.643,00₺	Sağ-Right	860-965 x 530 x 530	500	1	0,132	23,400	24,600



Gövde
Main

20

Kapak
Lid

15



Bağımsız Körköşe Mekanizması
Independent Secret Corner Mechanism

Renk Seçenekleri
Color Options

S-XXXX-C
CHROME

S-XXXX-A
ANTHRACITE

Tel	Ürün Kodu		Yön Direction	W x D x H (mm)	C (mm)	Koli	Hacim (m³)	Ağırlık kg.		
	Fiyat	Ahşap						Fiyat	Tel	Ahşap
S-3005-	1.524,00₺	S-3065-	1.587,00₺	Sol-Left	600 x 510 x 560	400	1	0,105	25,920	27,200
S-3006-	1.524,00₺	S-3066-	1.587,00₺	Sağ-Right	600 x 510 x 560	400	1	0,105	25,920	27,200
S-3007-	1.554,00₺	S-3067-	1.686,00₺	Sol-Left	640 x 510 x 560	450	1	0,105	26,730	28,000
S-3008-	1.554,00₺	S-3068-	1.686,00₺	Sağ-Right	640 x 510 x 560	450	1	0,105	26,730	28,000
S-3009-	1.554,00₺	S-3069-	1.686,00₺	Sol-Left	700 x 510 x 560	500	1	0,105	26,730	28,000
S-3010-	1.554,00₺	S-3070-	1.686,00₺	Sağ-Right	700 x 510 x 560	500	1	0,105	26,730	28,000
S-3111-	1.585,00₺	S-3171-	1.779,00₺	Sol-Left	800 x 510 x 560	550	1	0,105	27,540	28,800
S-3112-	1.585,00₺	S-3172-	1.779,00₺	Sağ-Right	800 x 510 x 560	550	1	0,105	27,540	28,800



SOFT CLOSING

40



Döner Tablalı Körköşe Mekanizması
Turnboard Secret Corner Mechanism

Renk Seçenekleri
Color Options

S-XXXX-C
CHROME

S-XXXX-A
ANTHRACITE

Ürün Kodu	W x D x H (mm)	C (mm)	Direction	Koli	Hacim (m³)	Ağırlık kg.	Fiyat
S-3103-	800 x 400 x 600	400	Sol-Left	1	0,059	11,400	916,00₺
S-3104-	800 x 400 x 600	400	Sağ-Right	1	0,059	11,400	916,00₺
S-3013-	850 x 475 x 600	450	Sol-Left	1	0,059	11,900	992,00₺
S-3014-	850 x 475 x 600	450	Sağ-Right	1	0,059	11,900	992,00₺
S-3113-	850 x 490 x 600	500	Sol-Left	1	0,059	12,400	1.094,00₺
S-3114-	850 x 490 x 600	500	Sağ-Right	1	0,059	12,400	1.094,00₺
S-3123-	880 x 495 x 600	600	Sol-Left	1	0,059	12,900	1.195,00₺
S-3124-	880 x 495 x 600	600	Sağ-Right	1	0,059	12,900	1.195,00₺



Kaymaz Yüzeyle Döner Tablalı Körköşe Mekanizması
Anti-Slip Surface Turnboard Secret Corner Mechanism

Renk Seçenekleri
Color Options

S-XXXX-C
CHROME

S-XXXX-A
ANTHRACITE

Ürün Kodu	W x D x H (mm)	C (mm)	Direction	Koli	Hacim (m³)	Ağırlık kg.	Fiyat
S-3105-	800 x 400 x 600	400	Sol-Left	1	0,059	11,500	1.062,00₺
S-3106-	800 x 400 x 600	400	Sağ-Right	1	0,059	11,500	1.062,00₺
S-3015-	850 x 475 x 600	450	Sol-Left	1	0,059	12,000	1.131,00₺
S-3016-	850 x 475 x 600	450	Sağ-Right	1	0,059	12,000	1.131,00₺
S-3115-	850 x 490 x 600	500	Sol-Left	1	0,059	12,500	1.246,00₺
S-3116-	850 x 490 x 600	500	Sağ-Right	1	0,059	12,500	1.246,00₺
S-3125-	880 x 495 x 600	600	Sol-Left	1	0,059	12,900	1.330,00₺
S-3126-	880 x 495 x 600	600	Sağ-Right	1	0,059	12,900	1.330,00₺

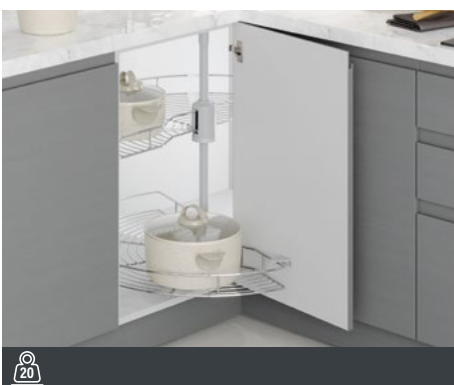

1/2 Borulu Döner Sepet Takımı
1/2 Turning Basket Set with Tube

Renk Seçenekleri
Color Options

S-XXXX-C
CHROME

S-XXXX-A
ANTHRACITE

Ürün Kodu	Ø x H (mm)	C (mm)	Koli	Hacim (m³)	Ağırlık kg.	Fiyat
S-3011-	Ø 740 x 420 x 650 - 700	450	1	0,051	4,750	287,00₺

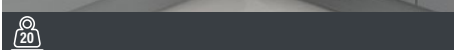

20



1/2 Borulu Döner Ahşap Tablı Sepet Takımı
1/2 Turning Basket Set with Wooden Bottom and Tube

Renk Seçenekleri
Color Options

S-XXXX-C
CHROME

S-XXXX-A
ANTHRACITE

Ürün Kodu	Ø x H (mm)	C (mm)	Koli	Hacim (m³)	Ağırlık kg.	Fiyat
S-3012-	Ø 740 x 420 x 650 - 700	450	1	0,051	10,250	667,00₺



3/4 Döner Sepet Takımı
3/4 Turning Basket Set

Renk Seçenekleri
Color Options

S-XXXX-C
CHROME

S-XXXX-A
ANTHRACITE

Ürün Kodu	Ø x H (mm)	C (mm)	Koli	Hacim (m³)	Ağırlık kg.	Fiyat
S-3020-	Ø 600 x 650 - 700	280 + 280	1	0,060	6,050	319,00₺
S-3021-	Ø 740 x 650 - 700	320 + 320	1	0,094	6,600	381,00₺
S-3022-	Ø 830 x 650 - 700	360 + 360	1	0,113	7,800	408,00₺



3/4 Döner Ahşap Tablı Sepet Takımı
3/4 Turning Basket Set with Wooden Bottom and Tube

Renk Seçenekleri
Color Options

S-XXXX-C
CHROME

S-XXXX-A
ANTHRACITE

Ürün Kodu	Ø x H (mm)	C (mm)	Koli	Hacim (m³)	Ağırlık kg.	Fiyat
S-3023-	Ø 600 x 650 - 700	280 + 280	1	0,071	6,050	607,00₺
S-3024-	Ø 740 x 650 - 700	320 + 320	1	0,087	6,600	749,00₺
S-3025-	Ø 830 x 650 - 700	360 + 360	1	0,113	7,800	810,00₺



Kaymaz Yüzeyle 3/4 Döner Ahşap Tablı Sepet Takımı
3/4 Anti-Slip Surface Turning Basket Set with Wooden Bottom and Tube

Renk Seçenekleri
Color Options

S-XXXX-C
CHROME

S-XXXX-A
ANTHRACITE

Ürün Kodu	Ø x H (mm)	C (mm)	Koli	Hacim (m³)	Ağırlık kg.	Fiyat
S-3026-	Ø 600 x 650 - 700	280 + 280	1	0,071	6,050	738,00₺
S-3027-	Ø 740 x 650 - 700	320 + 320	1	0,087	6,600	962,00₺
S-3028-	Ø 830 x 650 - 700	360 + 360	1	0,113	7,800	1.052,00₺



3/4 Borusuz Ahşap Tablılı Döner Sepet Takımı 3/4 Turning Basket Set without Tube

Renk Seçenekleri
Color Options

S-XXXX-C
CHROME

S-XXXX-A
ANTHRACITE

Ürün Kodu	Ø x H (mm)	C (mm)	Koli	Hacim (m ³)	Ağırlık kg.	Fiyat
S-3051-	Ø 750 x 600	320 + 320	1	0,113	16,000	850,00₺



3/4 Borusuz Kaymaz Yüzeyleli Ahşap Tablılı Döner Sepet Takımı 3/4 Anti-Slip Surface Turning Basket Set without Tube

Renk Seçenekleri
Color Options

S-XXXX-C
CHROME

S-XXXX-A
ANTHRACITE

Ürün Kodu	Ø x H (mm)	C (mm)	Koli	Hacim (m ³)	Ağırlık kg.	Fiyat
S-3052-	Ø 750 x 600	320 + 320	1	0,113	16,000	1.077,00₺



4/4 Döner Sepet Takımı 4/4 Turning Basket Set

Renk Seçenekleri
Color Options

S-XXXX-C
CHROME

S-XXXX-A
ANTHRACITE

Ürün Kodu	Ø x H (mm)	C (mm)	Koli	Hacim (m ³)	Ağırlık kg.	Fiyat
S-3031-	Ø 600 x 700	400	1	0,094	9,850	694,00₺
S-3032-	Ø 750 x 700	450	1	0,094	11,950	720,00₺



4/4 Klasik Döner Sepet Takımı 4/4 Classic Turning Basket Set

Renk Seçenekleri
Color Options

S-XXXX-C
CHROME

S-XXXX-A
ANTHRACITE

Ürün Kodu	Ø x H (mm)	C (mm)	Koli	Hacim (m ³)	Ağırlık kg.	Fiyat
S-3033-	Ø 600 x 700	400	1	0,060	5,400	325,00₺
S-3034-	Ø 750 x 700	450	1	0,092	7,000	360,00₺



4/4 Klasik Döner Ahşap Tablı Sepet Takımı
4/4 Turning Basket Set with Wooden Bottom

Renk Seçenekleri
Color Options

S-XXXX-C
CHROME

S-XXXX-A
ANTHRACITE

Ürün Kodu	Ø x H (mm)	C (mm)	Koli	Hacim (m ³)	Ağırlık kg.	Fiyat
S-3133-	Ø 600 x 650 - 700	280 + 280	1	0,071	6,050	595,00₺
S-3134-	Ø 750 x 650 - 700	320 + 320	1	0,087	6,600	762,00₺



Kaymaz Yüzeyle 4/4 Klasik Döner Ahşap Tablı Sepet Takımı
4/4 Anti-Slip Surface Classic Turning Basket Set with Wooden Bottom

Renk Seçenekleri
Color Options

S-XXXX-C
CHROME

S-XXXX-A
ANTHRACITE

Ürün Kodu	Ø x H (mm)	C (mm)	Koli	Hacim (m ³)	Ağırlık kg.	Fiyat
S-3138-	Ø 600 x 650 - 700	280 + 280	1	0,071	6,050	773,00₺
S-3139-	Ø 750 x 650 - 700	320 + 320	1	0,087	6,600	1.015,00₺



4/4 Borusuz Ahşap Tablı Döner Sepet Takımı
4/4 Turning Basket Set without Tube

Renk Seçenekleri
Color Options

S-XXXX-C
CHROME

S-XXXX-A
ANTHRACITE

Ürün Kodu	Ø x H (mm)	C (mm)	Koli	Hacim (m ³)	Ağırlık kg.	Fiyat
S-3053-	Ø 750 x 600	450	1	0,120	18,000	865,00₺



4/4 Borusuz Kaymaz Yüzeyle Ahşap Tablı Döner Sepet Takımı
4/4 Anti-Slip Surface Turning Basket Set without Tube

Renk Seçenekleri
Color Options

S-XXXX-C
CHROME

S-XXXX-A
ANTHRACITE

Ürün Kodu	Ø x H (mm)	C (mm)	Koli	Hacim (m ³)	Ağırlık kg.	Fiyat
S-3054-	Ø 750 x 600	450	1	0,120	18,000	1.254,00₺



Folyoluk
Foil-Paper Roll Holder

Renk Seçenekleri
Color Options

S-XXXX-A
ANTHRACITE

Ürün Kodu	W x D x H (mm)	Koli	Hacim (m³)	Ağırlık kg.	Fiyat
S-4129-	330 x 140 x 360	10	0,203	17,500	138,00₺



Ahşap İki Büyük Rafly Baharatlık
Wooden Spice Set with 2 Big Shelves

Renk Seçenekleri
Color Options

S-XXXX-A
ANTHRACITE

Ürün Kodu	W x D x H (mm)	Koli	Hacim (m³)	Ağırlık kg.	Fiyat
S-4126-	330 x 165 x 360	10	0,242	19,600	161,00₺



Ahşap Tek Büyük Rafly Baharatlık
Wooden Spice Set with 1 Big Shelf

Renk Seçenekleri
Color Options

S-XXXX-A
ANTHRACITE

Ürün Kodu	W x D x H (mm)	Koli	Hacim (m³)	Ağırlık kg.	Fiyat
S-4124-	360 x 165 x 300	10	0,272	12,000	116,00₺



Ahşap İki Küçük Rafly Baharatlık
Wooden Spice Set with 2 Small Shelves

Renk Seçenekleri
Color Options

S-XXXX-A
ANTHRACITE

Ürün Kodu	W x D x H (mm)	Koli	Hacim (m³)	Ağırlık kg.	Fiyat
S-4125-	350 x 130 x 360	10	0,197	16,000	138,00₺



Ahşap Tek Küçük Rafly Baharatlık
Wooden Spice Set with 1 Small Shelf

Renk Seçenekleri
Color Options

S-XXXX-A
ANTHRACITE

Ürün Kodu	W x D x H (mm)	Koli	Hacim (m³)	Ağırlık kg.	Fiyat
S-4123-	350 x 130 x 300	10	0,193	10,500	100,00₺



Ahşap Küçük-Büyük Rafli Baharatlık
Wooden Spice Set with 1 Big & 1 Small Shelves

Renk Seçenekleri
Color Options

S-XXXX-A
ANTHRACITE

Ürün Kodu	W x D x H (mm)	Koli	Hacim (m³)	Ağırlık kg.	Fiyat
S-4127-	350 x 165 x 360	10	0,242	18,000	154,00₺



Lüks Folyoluk
Luxury Foil-Paper Roll Holder

Renk Seçenekleri
Color Options

S-XXXX-C
CHROME

S-XXXX-A
ANTHRACITE

Ürün Kodu	W x D x H (mm)	Koli	Hacim (m³)	Ağırlık kg.	Fiyat
S-4021-	355 x 180 x 400	10	0,335	30,100	184,00₺



Lüks Havluluk
Luxury Towel Holder

Renk Seçenekleri
Color Options

S-XXXX-C
CHROME

S-XXXX-A
ANTHRACITE

Ürün Kodu	W x D x H (mm)	Koli	Hacim (m³)	Ağırlık kg.	Fiyat
S-4023-	355 x 180 x 265	10	0,272	14,650	83,00₺



Lüks Tek Küçük Rafli Baharatlık
Luxury Spice Set with 1 Small Shelf

Renk Seçenekleri
Color Options

S-XXXX-C
CHROME

S-XXXX-A
ANTHRACITE

Ürün Kodu	W x D x H (mm)	Koli	Hacim (m³)	Ağırlık kg.	Fiyat
S-4025-	355 x 165 x 265	10	0,192	15,700	104,00₺



Lüks Tek Büyük Rafli Baharatlık
Luxury Spice Set with 1 Big Shelf

Renk Seçenekleri
Color Options

S-XXXX-C
CHROME

S-XXXX-A
ANTHRACITE

Ürün Kodu	W x D x H (mm)	Koli	Hacim (m³)	Ağırlık kg.	Fiyat
S-4027-	355 x 210 x 265	10	0,272	19,250	110,00₺



Lüks İki Küçük Rafly Baharatlık
Luxury Spice Set with 2 Small Shelves

Renk Seçenekleri
Color Options

S-XXXX-C
CHROME

S-XXXX-A
ANTHRACITE

Ürün Kodu	W x D x H (mm)	Koli	Hacim (m³)	Ağırlık kg.	Fiyat
S-4029-	355 x 165 x 390	10	0,255	26,850	157,00₺



Lüks İki Büyük Rafly Baharatlık
Luxury Spice Set with 2 Big Shelves

Renk Seçenekleri
Color Options

S-XXXX-C
CHROME

S-XXXX-A
ANTHRACITE

Ürün Kodu	W x D x H (mm)	Koli	Hacim (m³)	Ağırlık kg.	Fiyat
S-4031-	355 x 210 x 400	10	0,335	30,500	183,00₺



Lüks Küçük-Büyük İki Rafly Baharatlık
Luxury Spice Set with 1 Small & 1 Big Shelves

Renk Seçenekleri
Color Options

S-XXXX-C
CHROME

S-XXXX-A
ANTHRACITE

Ürün Kodu	W x D x H (mm)	Koli	Hacim (m³)	Ağırlık kg.	Fiyat
S-4033-	355 x 210 x 400	10	0,335	29,500	155,00₺



Lüks Köşe Sepeti
Luxury Corner Shelf

Renk Seçenekleri
Color Options

S-XXXX-C
CHROME

S-XXXX-A
ANTHRACITE

Ürün Kodu	W x D x H (mm)	Koli	Hacim (m³)	Ağırlık kg.	Fiyat
S-4035-	310 x 310 x 265	10	0,109	20,000	129,00₺



Ahşap Bıçaklık
Wooden Knife Holder

Renk Seçenekleri
Color Options

S-XXXX-C
CHROME

S-XXXX-A
ANTHRACITE

Ürün Kodu	W x D x H (mm)	Koli	Hacim (m³)	Ağırlık kg.	Fiyat
S-4101-	280 x 115 x 385	10	0,171	18,800	185,00₺



Ahşap Kesme Tablası ve Askısı
Wooden Cutting Board and Rack

Renk Seçenekleri
Color Options

S-XXXX-C
CHROME

S-XXXX-A
ANTHRACITE

Ürün Kodu	W x D x H (mm)	Koli	Hacim (m³)	Ağırlık kg.	Fiyat
S-4103-	210 x 115 x 330	10	0,109	9,800	120,00₺



Ahşap Çatal-Kaşık Askısı
Wooden Fork-Spoon Rack

Renk Seçenekleri
Color Options

S-XXXX-C
CHROME

S-XXXX-A
ANTHRACITE

Ürün Kodu	W x D x H (mm)	Koli	Hacim (m³)	Ağırlık kg.	Fiyat
S-4109-	100 x 115 x 300	10	0,071	6,700	146,00₺



Klasik Folyoluk
Classical Foil-Paper Holder

Renk Seçenekleri
Color Options

S-XXXX-C
CHROME

S-XXXX-A
ANTHRACITE

Ürün Kodu	W x D x H (mm)	Koli	Hacim (m³)	Ağırlık kg.	Fiyat
S-4001-	330 x 140 x 360	10	0,203	17,500	129,00₺



Klasik Folyoluk İkili
Classical Foil-Paper Holder (Double)

Renk Seçenekleri
Color Options

S-XXXX-C
CHROME

S-XXXX-A
ANTHRACITE

Ürün Kodu	W x D x H (mm)	Koli	Hacim (m³)	Ağırlık kg.	Fiyat
S-4010-	330 x 130 x 300	10	0,203	13,400	96,00₺



Klasik Havluluk
Classical Towel Holder

Renk Seçenekleri
Color Options

S-XXXX-C
CHROME

S-XXXX-A
ANTHRACITE

Ürün Kodu	W x D x H (mm)	Koli	Hacim (m³)	Ağırlık kg.	Fiyat
S-4002-	280 x 140 x 310	10	0,193	8,750	68,00₺



Havlu Askılı Baharatlık
Spice Holder with Towel Hanger

Renk Seçenekleri
Color Options

S-XXXX-C
CHROME

S-XXXX-A
ANTHRACITE

Ürün Kodu	W x D x H (mm)	Koli	Hacim (m³)	Ağırlık kg.	Fiyat
S-4604-	350 x 150 x 350	10	0,257	14,850	82,00₺



Klasik Tek Küçük Rafı Baharatlık
Classical Spice Set with 1 Small Shelf

Renk Seçenekleri
Color Options

S-XXXX-C
CHROME

S-XXXX-A
ANTHRACITE

Ürün Kodu	W x D x H (mm)	Koli	Hacim (m³)	Ağırlık kg.	Fiyat
S-4003-	350 x 130 x 310	10	0,193	11,150	79,00₺



Klasik Tek Büyük Rafı Baharatlık
Classical Spice Set with 1 Big Shelf

Renk Seçenekleri
Color Options

S-XXXX-C
CHROME

S-XXXX-A
ANTHRACITE

Ürün Kodu	W x D x H (mm)	Koli	Hacim (m³)	Ağırlık kg.	Fiyat
S-4004-	350 x 165 x 310	10	0,272	14,050	89,00₺



Klasik İki Küçük Rafı Baharatlık
Classical Spice Set with 2 Small Shelves

Renk Seçenekleri
Color Options

S-XXXX-C
CHROME

S-XXXX-A
ANTHRACITE

Ürün Kodu	W x D x H (mm)	Koli	Hacim (m³)	Ağırlık kg.	Fiyat
S-4005-	350 x 130 x 360	10	0,197	16,650	109,00₺



Klasik İki Büyük Rafı Baharatlık
Classical Spice Set with 2 Big Shelves

Renk Seçenekleri
Color Options

S-XXXX-C
CHROME

S-XXXX-A
ANTHRACITE

Ürün Kodu	W x D x H (mm)	Koli	Hacim (m³)	Ağırlık kg.	Fiyat
S-4006-	350 x 165 x 360	10	0,242	19,850	124,00₺



Klasik Küçük - Büyük İki Rafli Baharatlık
Classical Spice Set with 1 Small & 1 Big Shelves

Renk Seçenekleri
Color Options

S-XXXX-C
CHROME

S-XXXX-A
ANTHRACITE

Ürün Kodu	W x D x H (mm)	Koli	Hacim (m³)	Ağırlık kg.	Fiyat
S-4007-	350 x 165 x 360	10	0,242	18,400	117,00₺



Klasik Köşe Sepeti
Classical Corner Shelf

Renk Seçenekleri
Color Options

S-XXXX-C
CHROME

S-XXXX-A
ANTHRACITE

Ürün Kodu	W x D x H (mm)	Koli	Hacim (m³)	Ağırlık kg.	Fiyat
S-4008-	315 x 335 x 300	10	0,109	12,550	107,00₺



Klasik İki Rafli Köşe Sepeti
Classical Corner Shelves (2 Divisions)

Renk Seçenekleri
Color Options

S-XXXX-C
CHROME

S-XXXX-A
ANTHRACITE

Ürün Kodu	W x D x H (mm)	Koli	Hacim (m³)	Ağırlık kg.	Fiyat
S-4009-	280 x 340 x 350	10	0,093	20,500	168,00₺



Askılı Şişelik
Bottle Holder with Hanger

Renk Seçenekleri
Color Options

S-XXXX-C
CHROME

S-XXXX-A
ANTHRACITE

Ürün Kodu	W x D x H (mm)	Koli	Hacim (m³)	Ağırlık kg.	Fiyat
S-4015-	250 x 115 x 400	10	0,177	13,150	80,00₺



Askılı Bardaklık
Glass Holder with Hanger

Renk Seçenekleri
Color Options

S-XXXX-C
CHROME

S-XXXX-A
ANTHRACITE

Ürün Kodu	W x D x H (mm)	Koli	Hacim (m³)	Ağırlık kg.	Fiyat
S-4601-	235 x 115 x 350	10	0,171	10,200	70,00₺



Yemek Kitabı Askısı
Cook Book Rack

Renk Seçenekleri
Color Options

S-XXXX-C
CHROME

S-XXXX-A
ANTHRACITE

Ürün Kodu	W x D x H (mm)	Koli	Hacim (m³)	Ağırlık kg.	Fiyat
S-4019-	460 x 375 x 390	10	0,239	20,830	134,00₺



Çatal-Kaşık Askısı
Fork-Spoon Rack

Renk Seçenekleri
Color Options

S-XXXX-C
CHROME

S-XXXX-A
ANTHRACITE

Ürün Kodu	W x D x H (mm)	Koli	Hacim (m³)	Ağırlık kg.	Fiyat
S-4110-	100 x 115 x 295	10	0,071	7,200	103,00₺



Askılı 8'li Baharatlık Seti
8 Spice Bottles with Hanger

Renk Seçenekleri
Color Options

S-XXXX-C
CHROME

S-XXXX-A
ANTHRACITE

Ürün Kodu	W x D x H (mm)	Koli	Hacim (m³)	Ağırlık kg.	Fiyat
S-4011-	505 x 55 x 300	10	0,161	15,500	143,00₺



8'li Baharatlık Seti
8 Spice Bottles Set

Renk Seçenekleri
Color Options

S-XXXX-C
CHROME

S-XXXX-A
ANTHRACITE

Ürün Kodu	W x D x H (mm)	Koli	Hacim (m³)	Ağırlık kg.	Fiyat
S-4012-	400 x 75 x 145	10	0,030	12,550	186,00₺



Baharat Şişesi
Spice Bottle

Renk Seçenekleri
Color Options

S-XXXX-C
CHROME

S-XXXX-A
ANTHRACITE

Ürün Kodu	Ø x H (mm)	Koli	Hacim (m³)	Ağırlık kg.	Fiyat
S-4093-	Ø 40 x 140	4	0,001	0,600	15,40₺



Kağıt Havluluk
Paper Roll Holder

Renk Seçenekleri
Color Options

S-XXXX-C
CHROME

S-XXXX-A
ANTHRACITE

Ürün Kodu	Ø x H (mm)	Koli	Hacim (m³)	Ağırlık kg.	Fiyat
S-4603-	Ø 160 x 320	10	0,032	4,950	54,00₺



Askılı Tabaklık-Bardaklık Seti
Plate-Glass Holder Set with Hanger

Renk Seçenekleri
Color Options

S-XXXX-C
CHROME

S-XXXX-A
ANTHRACITE

Ürün Kodu	W x D x H (mm)	Koli	Hacim (m³)	Ağırlık kg.	Fiyat
S-4020-	580 x 280 x 300	1	0,026	3,700	238,00₺

Renk Seçenekleri
Color Options

S-XXXX-SS
STAINLESS STEEL

Ürün Kodu	W x D x H (mm)	Koli	Hacim (m³)	Ağırlık kg.	Fiyat
S-4020-	580 x 280 x 300	1	0,026	3,700	471,00₺



- 1 Adet Folyoluk
- 1 Adet Küçük Büyük İki Rafılı Baharatlık
- 1 Adet Çatal-Kaşık Askısı
- 2 Adet Boru Ø16x500
- 3 Adet Boru Bağlantısı
- 5 Adet S Kanca

- 1 Pc Foil-Paper Holder
- 1 Pc Spice Set with 1 Small & 1 Big Shelf
- 1 Pc Fork-Spoon Rack
- 2 Pcs Tubes Ø16x500
- 3 Pcs Tube Connection Elements
- 5 Pcs S-Hooks

Set Arası Takım 1
Midway Set 1

Renk Seçenekleri
Color Options

S-XXXX-C
CHROME

S-XXXX-A
ANTHRACITE

Ürün Kodu	W x D x H (mm)	Koli	Hacim (m³)	Ağırlık kg.	Fiyat
S-4500-	1000 x 170 x 360	1	0,029	4,400	380,00₺



- 1 Adet Folyoluk
- 1 Adet Küçük Büyük İki Rafılı Baharatlık
- 2 Adet Boru Ø16x500
- 3 Adet Boru Bağlantısı
- 4 Adet S Kanca

- 1 Pc Foil-Paper Holder
- 1 Pc Spice Set with 1 Small & 1 Big Shelf
- 2 Pcs Tubes Ø16x500
- 3 Pcs Tube Connection Elements
- 4 Pcs S-Hooks

Set Arası Takım 2
Midway Set 2

Renk Seçenekleri
Color Options

S-XXXX-C
CHROME

S-XXXX-A
ANTHRACITE

Ürün Kodu	W x D x H (mm)	Koli	Hacim (m³)	Ağırlık kg.	Fiyat
S-4522-	1000 x 170 x 360	1	0,029	3,500	288,00₺



- 1 Adet Ahşap Bıçaklık
- 1 Adet Ahşap Kesme Tablası ve Askısı
- 1 Adet Ahşap Çatal-Kaşık Askısı
- 2 Adet Boru Ø16x500
- 3 Adet Boru Bağlantısı
- 5 Adet S Kanca

- 1 Pcs Wooden Knife Holder
- 1 Pcs Wooden Cutting Board and Rack
- 1 Pcs Wooden Fork-Spoon Rack
- 2 Pcs Tubes Ø16x500
- 3 Pcs Tube Connection Elements
- 5 Pcs S-Hooks

Set Arası Takım 4 Midway Set 4

Renk Seçenekleri
Color Options

S-XXXX-C
CHROME

S-XXXX-A
ANTHRACITE

Ürün Kodu	W x D x H (mm)	Koli	Hacim (m³)	Ağırlık kg.	Fiyat
S-4525-	1000 x 115 x 385	1	0,351	3,530	504,00₺



← Max: 86 cm →

Evye Üstü Düzenleyici (Orta Boy) Over Sink Organizer (Medium)

Renk Seçenekleri
Color Options

S-XXXX-A
ANTHRACITE

Ürün Kodu	W x D x H (mm)	Koli	Hacim (m³)	Ağırlık kg.	Fiyat
S-4151-	975 x 320 x 525	1	0,038	6,050	737,00₺



← Max: 120 cm →

Evye Üstü Düzenleyici (Büyük Boy) Over Sink Organizer (Large)

Renk Seçenekleri
Color Options

S-XXXX-A
ANTHRACITE

Ürün Kodu	W x D x H (mm)	Koli	Hacim (m³)	Ağırlık kg.	Fiyat
S-4152-	1350 x 320 x 525	1	0,076	8,700	995,00₺



Kadeh Askılı Şişelik Bottle Holder with Glass Rack

Renk Seçenekleri
Color Options

S-XXXX-C
CHROME

S-XXXX-A
ANTHRACITE

Ürün Kodu	W x D x H (mm)	Koli	Hacim (m³)	Ağırlık kg.	Fiyat
S-4055-	410 x 260 x 340	1	0,039	2,750	138,00₺



Setüstü Tabaklık-Bardaklık
Plate-Glass Holder For Upper Set

Renk Seçenekleri
Color Options

S-XXXX-C
CHROME

S-XXXX-A
ANTHRACITE

Ürün Kodu	W x D x H (mm)	Koli	Hacim (m³)	Ağırlık kg.	Fiyat
S-4017-	435 x 270 x 275	1	0,028	1,750	146,00₺

Renk Seçenekleri
Color Options

S-XXXX-SS
STAINLESS STEEL

Ürün Kodu	W x D x H (mm)	Koli	Hacim (m³)	Ağırlık kg.	Fiyat
S-4017-	435 x 270 x 275	1	0,028	1,750	250,00₺



Setüstü Çatal-Kaşık Bölmeli Tabaklık-Bardaklık
Plate-Glass Holder for Upper Set with Fork-Spoon Dividers

Renk Seçenekleri
Color Options

S-XXXX-C
CHROME

S-XXXX-A
ANTHRACITE

Ürün Kodu	W x D x H (mm)	Koli	Hacim (m³)	Ağırlık kg.	Fiyat
S-4028-	430 x 330 x 275	1	0,038	2,500	181,00₺

Renk Seçenekleri
Color Options

S-XXXX-SS
STAINLESS STEEL

Ürün Kodu	W x D x H (mm)	Koli	Hacim (m³)	Ağırlık kg.	Fiyat
S-4028-	430 x 330 x 275	1	0,038	2,500	274,00₺



Askılı Tabaklık Bardaklık
Plate-Glass Holder with Hanger

Renk Seçenekleri
Color Options

S-XXXX-C
CHROME

S-XXXX-A
ANTHRACITE

Ürün Kodu	W x D x H (mm)	Koli	Hacim (m³)	Ağırlık kg.	Fiyat
S-4018-	490 x 240 x 470	1	0,056	2,600	167,00₺

Renk Seçenekleri
Color Options

S-XXXX-SS
STAINLESS STEEL

Ürün Kodu	W x D x H (mm)	Koli	Hacim (m³)	Ağırlık kg.	Fiyat
S-4018-	490 x 240 x 470	1	0,056	2,600	304,00₺



Askılı Kadehlik (3 Bölmeli)
Glass Rack with Hanger (3 Divisions)

Renk Seçenekleri
Color Options

S-XXXX-C
CHROME

S-XXXX-A
ANTHRACITE

Ürün Kodu	W x D x H (mm)	Koli	Hacim (m³)	Ağırlık kg.	Fiyat
S-4602-	280 x 280 x 175	10	0,032	5,330	54,00₺



Askılı Kadehlik (5 Bölmeli) Glass Rack with Hanger (5 Divisions)

Renk Seçenekleri
Color Options

S-XXXX-C
CHROME

S-XXXX-A
ANTHRACITE

Ürün Kodu	W x D x H (mm)	Koli	Hacim (m³)	Ağırlık kg.	Fiyat
S-4013-	540 x 55 x 180	10	0,037	7,200	55,00₺



Kadeh Askısı (1-2-4 Bölmeli) Glass Rack (1-2-4 Divisions)

Renk Seçenekleri
Color Options

S-XXXX-C
CHROME

S-XXXX-A
ANTHRACITE

Ürün Kodu	W x D x H (mm)	Koli	Division	Hacim (m³)	Ağırlık kg.	Fiyat
S-4041-	120 x 355 x 70	10	1	3,300	17,700	40,00₺
S-4042-	120 x 500 x 70	10	1	3,900	18,600	44,00₺
S-4016-	235 x 355 x 70	20	2	12,600	19,900	55,00₺
S-4045-	235 x 500 x 70	10	2	7,950	20,550	59,00₺
S-4043-	460 x 355 x 70	10	4	12,750	21,700	88,00₺
S-4044-	460 x 500 x 70	10	4	15,800	23,250	95,00₺



Kadeh Askısı (5 Bölmeli) Glass Rack (5 Divisions)

Renk Seçenekleri
Color Options

S-XXXX-C
CHROME

S-XXXX-A
ANTHRACITE

Ürün Kodu	W x D x H (mm)	Koli	Hacim (m³)	Ağırlık kg.	Fiyat
S-4014-	460 x 250 x 160	10	0,037	10,250	83,00₺



Bar Seti Bar Set

Renk Seçenekleri
Color Options

S-XXXX-C
CHROME

S-XXXX-A
ANTHRACITE

Ürün Kodu	W x D x H (mm)	Koli	Hacim (m³)	Ağırlık kg.	Fiyat
S-4111-	1000 x 360 x 480	1	0,068	6,550	529,00₺



Köşe Boru
Corner Tube

Renk Seçenekleri
Color Options

S-XXXX-C
CHROME

S-XXXX-A
ANTHRACITE

Ürün Kodu	Ø x L1 x L2 (mm)	Koli	Hacim (m³)	Ağırlık kg.	Fiyat
S-4051-	16 x 290 x 370	10	0,015	3,125	31,10₺



Boru
Tube

Renk Seçenekleri
Color Options

S-XXXX-C
CHROME

S-XXXX-A
ANTHRACITE

Ürün Kodu	Ø x L (mm)	Koli	Hacim (m³)	Ağırlık kg.	Fiyat
S-4061-	Ø 16 x 500	10	0,003	2,050	21,00₺
S-4062-	Ø 16 x 600	10	0,003	3,650	25,00₺
S-4063-	Ø 16 x 800	10	0,004	3,350	31,00₺
S-4064-	Ø 16 x 1000	10	0,005	4,400	37,00₺
S-4065-	Ø 16 x 1200	10	0,006	5,250	47,00₺



Boru Tapası
Tube Plug

Renk Seçenekleri
Color Options

S-XXXX-C
CHROME

S-XXXX-A
ANTHRACITE

Ürün Kodu	Ø x L (mm)	Koli	Hacim (m³)	Ağırlık kg.	Fiyat
S-4081-	Ø 16 x 12	100	0,001	0,140	1,80₺



Boru Bağlantısı
Tube Connection Element

Renk Seçenekleri
Color Options

S-XXXX-C
CHROME

S-XXXX-A
ANTHRACITE

Ürün Kodu	W x D x H (mm)	Koli	Hacim (m³)	Ağırlık kg.	Fiyat
S-4085-	20 x 20 x 50	200	0,016	13,000	14,00₺



S-Kanca
S-Hook

Renk Seçenekleri
Color Options

S-XXXX-C
CHROME

S-XXXX-A
ANTHRACITE

Ürün Kodu	W x D x H (mm)	Koli	Hacim (m³)	Ağırlık kg.	Fiyat
S-4091-	40 x 5 x 60	50	0,001	0,600	2,80₺



Tabak Rafı Plate Shelf

Ürün Kodu	W x D x H (mm)	C (mm)	Koli	Hacim (m³)	Renk Seçenekleri Color Options	
					§-XXXX-C GRAY	§-XXXX-A ANTHRACITE
S-5151-	560 - 570 x 270 x 110	600	10	0,050	9,100	68,00₺
S-5152-	660 - 670 x 270 x 110	700	10	0,058	10,450	72,00₺
S-5153-	760 - 770 x 270 x 110	800	10	0,067	11,700	76,00₺
S-5154-	860 - 870 x 270 x 110	900	10	0,076	13,400	81,00₺

Ürün Kodu	W x D x H (mm)	C (mm)	Koli	Hacim (m³)	Renk Seçenekleri Color Options	
					§-XXXX-CP SHINE FEEL	§-XXXX-SS SHINE FEEL
S-5151-	560 - 570 x 270 x 110	600	10	0,050	9,100	70,00₺
S-5152-	660 - 670 x 270 x 110	700	10	0,058	10,450	75,00₺
S-5153-	760 - 770 x 270 x 110	800	10	0,067	11,700	81,00₺
S-5154-	860 - 870 x 270 x 110	900	10	0,076	13,400	86,00₺

Ürün Kodu	W x D x H (mm)	C (mm)	Koli	Hacim (m³)	Renk Seçenekleri Color Options	
					§-XXXX-CP SHINE FEEL	§-XXXX-SS SHINE FEEL
S-5151-	560 - 570 x 270 x 110	600	10	0,050	9,100	142,00₺
S-5152-	660 - 670 x 270 x 110	700	10	0,058	10,450	145,00₺
S-5153-	760 - 770 x 270 x 110	800	10	0,067	11,700	160,00₺
S-5154-	860 - 870 x 270 x 110	900	10	0,076	13,400	168,00₺

Yüksek Bölmeli Tabak Rafı Plate Shelf with High Divisions

Ürün Kodu	W x D x H (mm)	C (mm)	Koli	Hacim (m³)	Renk Seçenekleri Color Options	
					§-XXXX-C GRAY	§-XXXX-A ANTHRACITE
S-5155-	560 - 570 x 270 x 130	600	10	0,050	7,850	72,00₺
S-5156-	660 - 670 x 270 x 130	700	10	0,058	9,400	75,00₺
S-5157-	760 - 770 x 270 x 130	800	10	0,067	10,500	78,00₺
S-5158-	860 - 870 x 270 x 130	900	10	0,076	11,900	86,00₺

Ürün Kodu	W x D x H (mm)	C (mm)	Koli	Hacim (m³)	Renk Seçenekleri Color Options	
					§-XXXX-CP SHINE FEEL	§-XXXX-SS SHINE FEEL
S-5155-	560 - 570 x 270 x 130	600	10	0,050	7,850	73,00₺
S-5156-	660 - 670 x 270 x 130	700	10	0,058	9,400	76,00₺
S-5157-	760 - 770 x 270 x 130	800	10	0,067	10,500	82,00₺
S-5158-	860 - 870 x 270 x 130	900	10	0,076	11,900	88,00₺

Ürün Kodu	W x D x H (mm)	C (mm)	Koli	Hacim (m³)	Renk Seçenekleri Color Options	
					§-XXXX-CP SHINE FEEL	§-XXXX-SS SHINE FEEL
S-5155-	560 - 570 x 270 x 130	600	10	0,050	7,850	161,00₺
S-5156-	660 - 670 x 270 x 130	700	10	0,058	9,400	168,00₺
S-5157-	760 - 770 x 270 x 130	800	10	0,067	10,500	180,00₺
S-5158-	860 - 870 x 270 x 130	900	10	0,076	11,900	194,00₺

Bardak Rafı Glass Shelf

Ürün Kodu	W x D x H (mm)	C (mm)	Koli	Hacim (m³)	Renk Seçenekleri Color Options	
					§-XXXX-C GRAY	§-XXXX-A ANTHRACITE
S-5052-	560 - 570 x 270 x 50	600	20	0,050	12,850	73,00₺
S-5054-	660 - 670 x 270 x 50	700	20	0,058	15,000	74,00₺
S-5056-	760 - 770 x 270 x 50	800	20	0,067	17,200	75,00₺
S-5058-	860 - 870 x 270 x 50	900	20	0,076	19,400	78,00₺

Ürün Kodu	W x D x H (mm)	C (mm)	Koli	Hacim (m³)	Renk Seçenekleri Color Options	
					§-XXXX-CP SHINE FEEL	§-XXXX-SS SHINE FEEL
S-5052-	560 - 570 x 270 x 50	600	20	0,050	12,850	66,00₺
S-5054-	660 - 670 x 270 x 50	700	20	0,058	15,000	74,00₺
S-5056-	760 - 770 x 270 x 50	800	20	0,067	17,200	78,00₺
S-5058-	860 - 870 x 270 x 50	900	20	0,076	19,400	82,00₺

Ürün Kodu	W x D x H (mm)	C (mm)	Koli	Hacim (m³)	Renk Seçenekleri Color Options	
					§-XXXX-CP SHINE FEEL	§-XXXX-SS SHINE FEEL
S-5052-	560 - 570 x 270 x 50	600	20	0,050	12,850	145,00₺
S-5054-	660 - 670 x 270 x 50	700	20	0,058	15,000	152,00₺
S-5056-	760 - 770 x 270 x 50	800	20	0,067	17,200	164,00₺
S-5058-	860 - 870 x 270 x 50	900	20	0,076	19,400	175,00₺

Plastik Tepsili Tabaklık - Bardaklık Seti Plate - Glass Shelf Set with Tray

Ürün Kodu	W x D x H (mm)	C (mm)	Koli	Hacim (m³)	Renk Seçenekleri Color Options	
					§-XXXX-C GRAY	§-XXXX-A ANTHRACITE
S-5163-	560 - 570 x 270	600	1	0,022	1,950	182,00₺
S-5164-	660 - 670 x 270	700	1	0,026	2,350	192,00₺
S-5165-	760 - 770 x 270	800	1	0,030	2,600	202,00₺
S-5166-	860 - 870 x 270	900	1	0,034	3,900	220,00₺

Ürün Kodu	W x D x H (mm)	C (mm)	Koli	Hacim (m³)	Renk Seçenekleri Color Options	
					§-XXXX-CP SHINE FEEL	§-XXXX-SS SHINE FEEL
S-5163-	560 - 570 x 270	600	1	0,022	1,950	152,00₺
S-5164-	660 - 670 x 270	700	1	0,026	2,350	179,00₺
S-5165-	760 - 770 x 270	800	1	0,030	2,600	194,00₺
S-5166-	860 - 870 x 270	900	1	0,034	3,900	204,00₺

Ürün Kodu	W x D x H (mm)	C (mm)	Koli	Hacim (m³)	Renk Seçenekleri Color Options	
					§-XXXX-CP SHINE FEEL	§-XXXX-SS SHINE FEEL
S-5163-	560 - 570 x 270	600	1	0,022	1,950	305,00₺
S-5164-	660 - 670 x 270	700	1	0,026	2,350	319,00₺
S-5165-	760 - 770 x 270	800	1	0,030	2,600	338,00₺
S-5166-	860 - 870 x 270	900	1	0,034	3,900	362,00₺



Alüminyum Profil Tepsili Tabaklık - Bardaklık Seti
Plate - Glass Shelf Set with Tray and Aluminium Profile

Renk Seçenekleri
Color Options

S-XXXX-C
CUBIC

S-XXXX-A
ANTIKMETS

Ürün Kodu	W x D x H (mm)	C (mm)	Koli	Hacim (m³)	Ağırlık kg.	Fiyat
S-5159-	560 x 295 - 345	600	1	0,022	2,450	200,00₺
S-5160-	660 x 295 - 345	700	1	0,026	2,850	213,00₺
S-5161-	760 x 295 - 345	800	1	0,030	3,150	230,00₺
S-5162-	860 x 295 - 345	900	1	0,034	3,500	250,00₺

Renk Seçenekleri
Color Options

S-XXXX-CP
CUBIC FEET

Ürün Kodu	W x D x H (mm)	C (mm)	Koli	Hacim (m³)	Ağırlık kg.	Fiyat
S-5159-	560 x 295 - 345	600	1	0,022	2,450	201,00₺
S-5160-	660 x 295 - 345	700	1	0,026	2,850	225,00₺
S-5161-	760 x 295 - 345	800	1	0,030	3,150	244,00₺
S-5162-	860 x 295 - 345	900	1	0,034	3,500	265,00₺

Renk Seçenekleri
Color Options

S-XXXX-SS
SINKLESS FEEL

Ürün Kodu	W x D x H (mm)	C (mm)	Koli	Hacim (m³)	Ağırlık kg.	Fiyat
S-5159-	560 x 295 - 345	600	1	0,022	2,450	356,00₺
S-5160-	660 x 295 - 345	700	1	0,026	2,850	371,00₺
S-5161-	760 x 295 - 345	800	1	0,030	3,150	393,00₺
S-5162-	860 x 295 - 345	900	1	0,034	3,500	419,00₺



Plastik Tabak Rafı
Plastic Plate Shelf

Renk Seçenekleri
Color Options

S-XXXX-T
TRANSPARENT

Ürün Kodu	W x D x H (mm)	C (mm)	Koli	Hacim (m³)	Ağırlık kg.	Fiyat
S-5221-	560 - 570 x 270 x 95	600	7	0,050	5,700	93,00₺
S-5222-	660 - 670 x 270 x 95	700	7	0,058	6,200	107,00₺
S-5223-	760 - 770 x 270 x 95	800	7	0,067	6,700	120,00₺
S-5224-	860 - 870 x 270 x 95	900	7	0,076	7,200	135,00₺



Plastik Bardak Rafı
Plastic Glass Shelf

Renk Seçenekleri
Color Options

S-XXXX-T
TRANSPARENT

Ürün Kodu	W x D x H (mm)	C (mm)	Koli	Hacim (m³)	Ağırlık kg.	Fiyat
S-5226-	560 - 570 x 270 x 50	600	7	0,050	5,300	92,00₺
S-5227-	660 - 670 x 270 x 50	700	7	0,058	5,700	107,00₺
S-5228-	760 - 770 x 270 x 50	800	7	0,067	6,100	123,00₺
S-5229-	860 - 870 x 270 x 50	900	7	0,076	6,500	140,00₺



Plastik Tepsili Tabaklık - Bardaklık Seti
Plastic Plate - Glass Shelf Set with Tray

Renk Seçenekleri
Color Options

S-XXXX-T
TRANSPARENT

Ürün Kodu	W x D x H (mm)	C (mm)	Koli	Hacim (m³)	Ağırlık kg.	Fiyat
S-5231-	560 - 570 x 270	600	1	0,022	1,690	213,00₺
S-5232-	660 - 670 x 270	700	1	0,026	2,190	257,00₺
S-5233-	760 - 770 x 270	800	1	0,030	2,690	285,00₺
S-5234-	860 - 870 x 270	900	1	0,034	3,190	328,00₺



Alüminyum Profil Plastik Tepsili Tabaklık - Bardaklık Seti Plastic Plate - Glass Shelf Set with Tray and Aluminium Profile

Renk Seçenekleri
Color Options

S-XXXX-T
TRANSPARENT

Ürün Kodu	W x D x H (mm)	C (mm)	Koli	Hacim (m ³)	Ağırlık kg.	Fiyat
S-5236-	560 - 570 x 270 600	600	1	0,022	2,020	248,00₺
S-5237-	660 - 670 x 270 700	700	1	0,026	2,520	294,00₺
S-5238-	760 - 770 x 270 800	800	1	0,030	3,020	328,00₺
S-5239-	860 - 870 x 270 900	900	1	0,034	3,520	374,00₺



Plastik Tepsiler / Plastic Trays

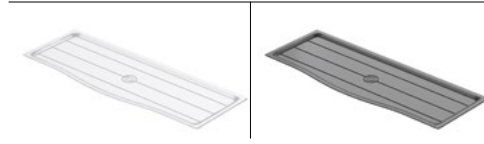

İki Katlı Raf Asansörü (Tepsili) Pull Down Shelf with Lift (with Trays)

Renk Seçenekleri
Color Options

S-XXXX-C
CHROME

S-XXXX-A
ANTHRACITE

Ürün Kodu	W x D x H (mm)	C (mm)	Koli	Hacim (m ³)	Ağırlık kg.	Fiyat
S-5181-	564 x 300 x 550	600	1	0,052	9,500	886,00₺
S-5182-	764 x 300 x 550	800	1	0,072	10,000	950,00₺
S-5183-	864 x 300 x 550	900	1	0,082	11,500	988,00₺



Kaymaz Yüzeyle Raf Asansörü Anti-Slip Surface Shelf Lift

Renk Seçenekleri
Color Options

S-XXXX-G
GREY

S-XXXX-A
ANTHRACITE

Ürün Kodu	W x D x H (mm)	C (mm)	Koli	Hacim (m ³)	Ağırlık kg.	Fiyat
S-5191-	564 x 300 x 550	600	1	0,052	9,500	944,00₺
S-5192-	764 x 300 x 550	800	1	0,072	10,000	999,00₺
S-5193-	864 x 300 x 550	900	1	0,082	11,500	1.048,00₺



Ahşap Tablalı Mini Döner Sepet Takımı
Wooden Mini Turning Basket Set

Renk Seçenekleri
Color Options

S-XXXX-C
CHROME

S-XXXX-A
ANTHRACITE

Ürün Kodu	W x D x H (mm)	C (mm)	Koli	Hacim (m ³)	Ağırlık kg.	Fiyat
S-5110-	564 x 490 x 445	600	1	0,063	10,500	862,00₺



Sabit Raf
Fixed Shelf

Renk Seçenekleri
Color Options

S-XXXX-C
CHROME

S-XXXX-A
ANTHRACITE

Ürün Kodu	W x D x H (mm)	C (mm)	Koli	Hacim (m ³)	Ağırlık kg.	Fiyat
S-5101-	560 x 470 x 60	600	1	0,035	3,080	160,00₺
S-5102-	860 x 470 x 60	900	1	0,053	4,440	199,00₺



Raylı Raf
Shelf with Rail

Renk Seçenekleri
Color Options

S-XXXX-C
CHROME

S-XXXX-A
ANTHRACITE

Ürün Kodu	W x D x H (mm)	C (mm)	Koli	Hacim (m ³)	Ağırlık kg.	Fiyat
S-5121-	560 x 470 x 60	600	1	0,035	4,460	312,00₺
S-5122-	860 x 470 x 60	900	1	0,053	5,700	357,00₺



Plastik Tepsi
Plastic Tray

Renk Seçenekleri
Color Options

S-XXXX-T
TRANSPARENT

S-XXXX-A
ANTHRACITE

Ürün Kodu	W x D x H (mm)	C (mm)	Koli	Hacim (m ³)	Ağırlık kg.	Fiyat
S-5212-	540 x 240 x 10	600	20	0,028	7,950	35,00₺
S-5213-	640 x 240 x 10	700	20	0,033	8,950	39,00₺
S-5214-	740 x 240 x 10	800	20	0,037	10,950	43,10₺
S-5215-	840 x 240 x 10	900	20	0,042	11,750	50,00₺



Teleskopik Raylı Döner Ayakkabılık Turning Shoe Rack with Telescopic Rail

Renk Seçenekleri
Color Options

S-XXXX-W
WHITE

S-XXXX-A
ANTHRACITE

Ürün Kodu	W x D x H (mm)	C (mm)	Koli	Baskets	Capacity	Hacim (m ³)	Ağırlık kg.	Fiyat
S-6831-	700 x 360 x 790 - 990	800	1	4	12	0,070	16,160	2.079,00₺
S-6832-	700 x 360 x 1070 - 1270	800	1	6	18	0,090	20,200	2.310,00₺
S-6833-	700 x 360 x 1350 - 1550	800	1	8	24	0,120	24,070	2.541,00₺
S-6834-	700 x 360 x 1630 - 1830	800	1	10	30	0,130	28,000	2.888,00₺
S-6835-	700 x 360 x 1910 - 2110	800	1	12	36	0,160	32,100	3.234,00₺

Raylı Raf Ünitesi Shelf Unit with Rail

Renk Seçenekleri
Color Options

S-XXXX-W
WHITE

S-XXXX-A
ANTHRACITE

Ürün Kodu	W x D x H (mm)	C (mm)	Koli	Baskets	Hacim (m ³)	Ağırlık kg.	Fiyat
S-6801-	340 x 510 x 1400-1600	400	1	4	0,074	17,700	1.208,00₺
S-6802-	340 x 510 x 1600-1800	400	1	5	0,084	18,950	1.365,00₺
S-6803-	340 x 510 x 1800-2000	400	1	5	0,094	20,200	1.523,00₺
S-6804-	340 x 510 x 2000-2200	400	1	6	0,104	21,450	1.680,00₺

Teleskopik Raylı Ahşap Raf Wooden Shelf with Telescopic Rail

Renk Seçenekleri
Color Options

S-XXXX-G
GREY

S-XXXX-W
WHITE

S-XXXX-A
ANTHRACITE

Ürün Kodu	W x D x H (mm)	C (mm)	Koli	Hacim (m ³)	Ağırlık kg.	Fiyat
S-6395-	560 x 356 x 50	600	1	0,015	3,100	225,00₺
S-6396-	660 x 356 x 50	700	1	0,017	3,300	240,00₺
S-6397-	760 x 356 x 50	800	1	0,020	3,500	253,00₺
S-6398-	860 x 356 x 50	900	1	0,023	3,700	268,00₺



Katlanır Ütü Masası
Foldable Ironing Board

Renk Seçenekleri
Color Options

S-XXXX-G
GREY

S-XXXX-W
WHITE

S-XXXX-A
ANTHRACITE

Ürün Kodu	W x D x H (mm)	C (mm)	Koli	Hacim (m ³)	Ağırlık kg.	Fiyat
S-6616-	330 x 495 x 150	400	1	0,025	8,050	1.050,00₺



Ütü Masası
Ironing Board

Renk Seçenekleri
Color Options

S-XXXX-G
GREY

S-XXXX-W
WHITE

S-XXXX-A
ANTHRACITE

Ürün Kodu	W x D x H (mm)	C (mm)	Koli	Hacim (m ³)	Ağırlık kg.	Fiyat
S-6611-	150 x 340 x 1480	200	1	0,073	13,140	1.621,00₺

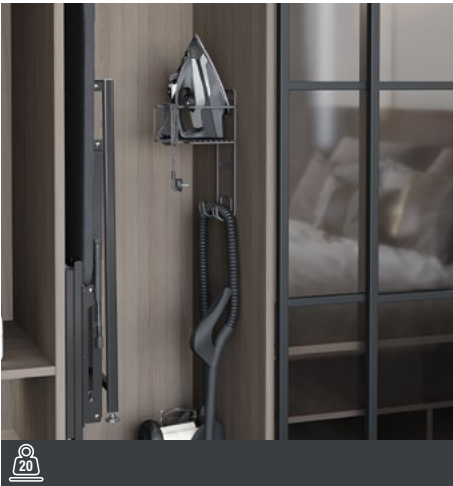

Ütü Askısı
Iron Rack

Renk Seçenekleri
Color Options

S-XXXX-C
CHROME

S-XXXX-A
ANTHRACITE

Ürün Kodu	W x D x H (mm)	Koli	Hacim (m ³)	Ağırlık kg.	Fiyat
S-6619-	200 x 200 x 380	1	0,015	1,150	98,00₺



Döner Ayna Mekanizması
Turning Mirror Mechanism

Renk Seçenekleri
Color Options

S-XXXX-G
GREY

S-XXXX-W
WHITE

S-XXXX-A
ANTHRACITE

Ürün Kodu	W x D x H (mm)	C (mm)	Koli	Hacim (m ³)	Ağırlık kg.	Fiyat
S-6612-	120 x 340 x 1300	200	1	0,062	10,000	866,00₺



Gardirop Asansörü Lift for Wardrobe

Renk Seçenekleri
Color Options

S-XXXX-G
GREY

S-XXXX-W
WHITE

S-XXXX-A
ANTHRACITE

Ürün Kodu	W x D x H (mm)	Koli	Hacim (m ³)	Ağırlık kg.	Fiyat
S-6013-	850 - 1150 x 285 x 900	6	0,077	20,720	303,00₺



Gardirop Asansörü Destek Parçası (10 Kg) Lift for Wardrobe Supporting Part (10 Kg)

Renk Seçenekleri
Color Options

S-XXXX-G
GREY

S-XXXX-W
WHITE

S-XXXX-A
ANTHRACITE

Ürün Kodu	W x D x H (mm)	Koli	Hacim (m ³)	Ağırlık kg.	Fiyat
S-6018-	25 x 286 x 114	20	0,001	0,095	17,00₺



Gardirop Asansörü Lift for Wardrobe

Renk Seçenekleri
Color Options

S-XXXX-G
GREY

S-XXXX-W
WHITE

S-XXXX-A
ANTHRACITE

Ürün Kodu	W x D x H (mm)	Koli	Hacim (m ³)	Ağırlık kg.	Fiyat
S-6014-	850 - 1150 x 290 x 900	6	0,077	21,240	332,00₺



Gardirop Asansörü Destek Parçası (15 Kg) Lift for Wardrobe Supporting Part (15 Kg)

Renk Seçenekleri
Color Options

S-XXXX-G
GREY

S-XXXX-W
WHITE

S-XXXX-A
ANTHRACITE

Ürün Kodu	W x D x H (mm)	Koli	Hacim (m ³)	Ağırlık kg.	Fiyat
S-6019-	25 x 154 x 283	20	0,001	0,110	18,40₺



Elbise Askı Aparatı Clothes Hanger Stick with Hook

Renk Seçenekleri
Color Options

S-XXXX-G
GREY

S-XXXX-W
WHITE

S-XXXX-A
ANTHRACITE

Ürün Kodu	W x D x H (mm)	Koli	Hacim (m ³)	Ağırlık kg.	Fiyat
S-6016-	40 x 85 x 1200	10	0,036	5,100	69,00₺



Döner Gardırop Mekanizması
Turning Wardrobe Mechanism

Renk Seçenekleri
Color Options **S-XXXX-G**
GREY

Ürün Kodu	W x D x H (mm)	C (mm)	2 Koli	Hacim (m ³)	Ağırlık kg.	Fiyat
S-6620-	780 x 500 x 1850 - 2000	900	1	0,296	34,800	4.928,00₺
S-6621-	780 x 500 x 2000 - 2150	900	1	0,348	39,500	5.747,00₺



Gizli Raylı Alüminyum Pantolonluk
Undermount Rail Aluminium Trousler Rack

Renk Seçenekleri
Color Options **S-XXXX-W**
WHITE **S-XXXX-A**
ANTHRACITE

Ürün Kodu	W x D x H (mm)	C (mm)	Koli	Hacim (m ³)	Ağırlık kg.	Fiyat
S-6707-	560 - 590 x 475 x 70	600	1	0,023	3,600	512,00₺
S-6708-	660 - 690 x 475 x 70	700	1	0,026	3,790	523,00₺
S-6709-	760 - 790 x 475 x 70	800	1	0,030	4,270	563,00₺
S-6710-	860 - 890 x 475 x 70	900	1	0,034	4,390	577,00₺



Gizli Raylı Alüminyum Çekmeceli Pantolonluk
Undermount Rail Aluminium Drawer and Trousler Rack

Renk Seçenekleri
Color Options **S-XXXX-W**
WHITE **S-XXXX-A**
ANTHRACITE

Ürün Kodu	W x D x H (mm)	C (mm)	Koli	Hacim (m ³)	Ağırlık kg.	Fiyat
S-6705-	760 - 790 x 475 x 100	800	1	0,034	5,970	714,00₺
S-6706-	860 - 890 x 475 x 100	900	1	0,038	6,220	740,00₺



Gizli Raylı Alüminyum Fonksiyonel Pantolonluk
Undermount Rail Aluminium Functional Trousler Rack

Renk Seçenekleri
Color Options **S-XXXX-W**
WHITE **S-XXXX-A**
ANTHRACITE

Ürün Kodu	W x D x H (mm)	C (mm)	Koli	Hacim (m ³)	Ağırlık kg.	Fiyat
S-6711-	560 - 590 x 475 x 125	600	1	0,023	5,430	681,00₺
S-6712-	660 - 690 x 475 x 125	700	1	0,027	6,020	716,00₺
S-6713-	760 - 790 x 475 x 125	800	1	0,032	6,610	726,00₺
S-6714-	860 - 890 x 475 x 125	900	1	0,037	7,180	762,00₺





Gizli Raylı Alüminyum Bölmeli Raf

Undermount Rail Aluminium Shelf with Division

Renk Seçenekleri
Color Options

S-XXXX-W
WHITE

S-XXXX-A
ANTHRACITE

Ürün Kodu	W x D x H (mm)	C (mm)	Koli	Hacim (m ³)	Ağırlık kg.	Fiyat
S-6715-	560 - 590 x 475 x 100	600	1	0,023	4,980	781,00₺
S-6716-	660 - 690 x 475 x 100	700	1	0,026	5,520	795,00₺
S-6717-	760 - 790 x 475 x 100	800	1	0,030	5,930	874,00₺
S-6718-	860 - 890 x 475 x 100	900	1	0,034	6,450	902,00₺

Gizli Raylı Alüminyum Çekmece

Undermount Rail Aluminium Drawer

Renk Seçenekleri
Color Options

S-XXXX-W
WHITE

S-XXXX-A
ANTHRACITE

Ürün Kodu	W x D x H (mm)	C (mm)	Koli	Hacim (m ³)	Ağırlık kg.	Fiyat
S-6701-	560 - 590 x 475 x 150	600	1	0,037	5,980	710,00₺
S-6702-	660 - 690 x 475 x 150	700	1	0,045	6,560	727,00₺
S-6703-	760 - 790 x 475 x 150	800	1	0,052	7,080	742,00₺
S-6704-	860 - 890 x 475 x 150	900	1	0,059	7,670	753,00₺

Gizli Raylı Alüminyum Ayakkabılık

Undermount Rail Aluminium Shoe Holder

Renk Seçenekleri
Color Options

S-XXXX-W
WHITE

S-XXXX-A
ANTHRACITE

Ürün Kodu	W x D x H (mm)	C (mm)	Koli	Hacim (m ³)	Ağırlık kg.	Fiyat
S-6731-	560 - 590 x 475 x 150	600	1	0,038	4,960	544,00₺
S-6719-	660 - 690 x 475 x 150	700	1	0,045	5,310	572,00₺
S-6720-	760 - 790 x 475 x 150	800	1	0,052	5,690	600,00₺
S-6732-	860 - 890 x 475 x 150	900	1	0,059	6,290	681,00₺

Gizli Raylı Alüminyum 4 Rafly Ayakkabılık

Undermount Rail Aluminium Shoe Holder with 4 Shelves

Renk Seçenekleri
Color Options

S-XXXX-W
WHITE

S-XXXX-A
ANTHRACITE

Ürün Kodu	W x D x H (mm)	Yön Direction	Koli	Hacim (m ³)	Ağırlık kg.	Fiyat
S-6741-	325 x 475 x 1000	Sol-Left	1	0,102	10,150	828,00₺
S-6742-	325 x 475 x 1000	Sağ-Right	1	0,102	10,150	828,00₺



Gizli Raylı Alüminyum 3 Rafı Ünite
Undermount Rail Aluminium Unit with 3 Shelves

Renk Seçenekleri
Color Options

S-XXXX-W
WHITE

S-XXXX-A
ANTHRACITE

Ürün Kodu	W x D x H (mm)	Yön Direction	Koli	Hacim (m ³)	Ağırlık kg.	Fiyat
S-6721-	325 x 475 x 1000	Sol-Left	1	0,078	9,750	1.067,00₺
S-6734-	325 x 475 x 1000	Sağ-Right	1	0,078	9,750	1.067,00₺



Yan Bağlantılı Gizli Raylı Alüminyum Fonksiyonel Pantolonluk
Side Mounted Undermount Rail Aluminium Functional Trouser Rack

Renk Seçenekleri
Color Options

S-XXXX-W
WHITE

S-XXXX-A
ANTHRACITE

Ürün Kodu	W x D x H (mm)	Yön Direction	Koli	Hacim (m ³)	Ağırlık kg.	Fiyat
S-6725-	400 x 475 x 290	Sağ-Right	1	0,010	3,870	616,00₺
S-6735-	400 x 475 x 290	Sol-Left	1	0,010	3,870	616,00₺



Gizli Raylı Alüminyum Fonksiyonel Kravatlık-Kemerlik
Undermount Rail Aluminium Functional Tie-Belt Rack

Renk Seçenekleri
Color Options

S-XXXX-W
WHITE

S-XXXX-A
ANTHRACITE

Ürün Kodu	W x D x H (mm)	Yön Direction	Koli	Hacim (m ³)	Ağırlık kg.	Fiyat
S-6726-	230 x 475 x 290	Sol-Left	1	0,010	2,960	506,00₺
S-6736-	230 x 475 x 290	Sağ-Right	1	0,010	2,960	506,00₺



Teleskopik Raylı Alüminyum Pantolon Askısı - Tekli
Telescopic Rail Aluminium Trouser Rack - Single

Renk Seçenekleri
Color Options

S-XXXX-W
WHITE

S-XXXX-A
ANTHRACITE

Ürün Kodu	W x D x H (mm)	C (mm)	Koli	Hacim (m ³)	Ağırlık kg.	Fiyat
S-6722-	360 x 460 x 150	400	1	0,043	4,550	339,00₺



Teleskopik Raylı Alüminyum Pantolon Askısı - İkili Telescopic Rail Aluminium Trousler Rack - Double

Renk Seçenekleri
Color Options

S-XXXX-W
WHITE

S-XXXX-A
ANTHRACITE

Ürün Kodu	W x D x H (mm)	C (mm)	Koli	Hacim (m ³)	Ağırlık kg.	Fiyat
S-6723-	610 x 460 x 145	700	1	0,023	5,420	461,00₺



Teleskopik Raylı Alüminyum Askılık Telescopic Rail Aluminium Rack

Renk Seçenekleri
Color Options

S-XXXX-W
WHITE

S-XXXX-A
ANTHRACITE

Ürün Kodu	W x D x H (mm)	C (mm)	Koli	Hacim (m ³)	Ağırlık kg.	Fiyat
S-6724-	80 x 460 x 150	600	1	0,008	2,450	276,00₺



Gizli Raylı Alüminyum Kravatlık Undermount Rail Aluminium Tie Rack

Renk Seçenekleri
Color Options

S-XXXX-W
WHITE

S-XXXX-A
ANTHRACITE

Ürün Kodu	W x D x H (mm)	Yön Direction	Koli	Hacim (m ³)	Ağırlık kg.	Fiyat
S-6727-	125 x 475 x 70	Sol-Left	1	0,006	1,500	227,00₺
S-6737-	125 x 475 x 70	Sağ-Right	1	0,006	1,500	227,00₺



Gizli Raylı Alüminyum Kravatlık-Kemerlik Undermount Rail Aluminium Tie-Belt Rack

Renk Seçenekleri
Color Options

S-XXXX-W
WHITE

S-XXXX-A
ANTHRACITE

Ürün Kodu	W x D x H (mm)	Yön Direction	Koli	Hacim (m ³)	Ağırlık kg.	Fiyat
S-6728-	125 x 475 x 70	Sol-Left	1	0,006	1,470	226,00₺
S-6729-	125 x 475 x 70	Sağ-Right	1	0,006	1,470	226,00₺



Gizli Raylı Alüminyum Kravatlık Undermount Rail Aluminium Tie Rack

Renk Seçenekleri
Color Options

S-XXXX-W
WHITE

S-XXXX-A
ANTHRACITE

Ürün Kodu	W x D x H (mm)	Yön Direction	Koli	Hacim (m ³)	Ağırlık kg.	Fiyat
S-6738-	125 x 475 x 70	Sol-Left	1	0,006	1,470	225,00₺
S-6739-	125 x 475 x 70	Sağ-Right	1	0,006	1,470	225,00₺



Plastik Kapaklı Teleskopik Raylı Pantolonluk
Plastic Cover Trousers Rack with Telescopic Rail

Renk Seçenekleri
Color Options

S-XXXX-G
GREY

S-XXXX-A
ANTHRACITE

Ürün Kodu	W x D x H (mm)	C (mm)	Koli	Hacim (m ³)	Ağırlık kg.	Fiyat
S-6301-	355 - 375 x 510 x 100	400	1	0,021	2,600	203,00₺
S-6302-	405 - 425 x 510 x 100	450	1	0,024	2,650	213,00₺
S-6303-	455 - 475 x 510 x 100	500	1	0,027	2,700	216,00₺
S-6304-	505 - 525 x 510 x 100	550	1	0,030	2,750	222,00₺
S-6305-	555 - 575 x 510 x 100	600	1	0,032	2,800	231,00₺
S-6306-	655 - 675 x 510 x 100	700	1	0,038	3,100	238,00₺
S-6307-	755 - 775 x 510 x 100	800	1	0,044	3,200	252,00₺
S-6308-	855 - 875 x 510 x 100	900	1	0,050	3,300	266,00₺

06



Plastik Kapaklı Teleskopik Raylı, Kutulu Eteklilik, Pantolonluk
Plastic Cover Koli, Skirt And Trousers Rack with Telescopic Rail

Renk Seçenekleri
Color Options

S-XXXX-G
GREY

S-XXXX-A
ANTHRACITE

Ürün Kodu	W x D x H (mm)	C (mm)	Koli	Hacim (m ³)	Ağırlık kg.	Fiyat	Fiyat
S-6317-	655 - 675 x 510 x 100	700	1	0,038	3,300	0,038	312,00₺
S-6318-	755 - 675 x 510 x 100	800	1	0,044	3,750	0,044	339,00₺
S-6319-	855 - 875 x 510 x 100	900	1	0,050	3,860	0,050	353,00₺



Plastik Kapaklı Teleskopik Raylı Aksesuarlık
Plastic Cover Accessory with Telescopic Rail

Renk Seçenekleri
Color Options

S-XXXX-G
GREY

S-XXXX-A
ANTHRACITE

Ürün Kodu	W x D x H (mm)	C (mm)	Koli	Hacim (m ³)	Ağırlık kg.	Fiyat
S-6326-	555 - 575 x 510 x 100	600	1	0,032	3,550	328,00₺
S-6327-	655 - 675 x 510 x 100	700	1	0,038	3,850	349,00₺
S-6328-	755 - 775 x 510 x 100	800	1	0,044	4,180	376,00₺
S-6329-	855 - 875 x 510 x 100	900	1	0,050	4,380	406,00₺



Teleskopik Raylı Alüminyum Pantolonluk
Aluminium Trousers Rack with Telescopic Rail

Renk Seçenekleri
Color Options

S-XXXX-G
GREY

S-XXXX-A
ANTHRACITE

Ürün Kodu	W x D x H (mm)	C (mm)	Koli	Hacim (m ³)	Ağırlık kg.	Fiyat
S-6201-	350 - 380 x 470 x 95	400	1	0,023	2,900	258,00₺
S-6202-	400 - 430 x 470 x 95	450	1	0,026	3,000	270,00₺
S-6203-	450 - 480 x 470 x 95	500	1	0,030	3,050	277,00₺
S-6204-	500 - 530 x 470 x 95	550	1	0,033	3,100	288,00₺



Teleskopik Raylı Alüminyum Pantolonluk - Kemer, Kravat Askılık
Aluminium Trousers Rack with Telescopic Rail - Tie, Belt Rack

Renk Seçenekleri
Color Options

S-XXXX-G
GREY

S-XXXX-A
ANTHRACITE

Ürün Kodu	W x D x H (mm)	C (mm)	Koli	Hacim (m ³)	Ağırlık kg.	Fiyat
S-6205-	550 - 580 x 470 x 95	600	1	0,036	3,200	316,00₺
S-6206-	650 - 680 x 470 x 95	700	1	0,042	3,500	337,00₺
S-6207-	750 - 780 x 470 x 95	800	1	0,048	3,800	358,00₺
S-6208-	850 - 880 x 470 x 95	900	1	0,054	4,050	388,00₺



Teleskopik Raylı Alüminyum Çekmece
Aluminium Drawer with Telescopic Rail

Renk Seçenekleri
Color Options

S-XXXX-G
GREY

S-XXXX-A
ANTHRACITE

Ürün Kodu	W x D x H (mm)	C (mm)	Koli	Hacim (m ³)	Ağırlık kg.	Fiyat
S-6221-	350 - 380 x 470 x 160	400	1	0,032	4,350	409,00₺
S-6222-	400 - 430 x 470 x 160	450	1	0,036	4,600	428,00₺
S-6223-	450 - 480 x 470 x 160	500	1	0,040	4,800	447,00₺
S-6224-	500 - 530 x 470 x 160	550	1	0,045	5,200	465,00₺
S-6225-	550 - 580 x 470 x 160	600	1	0,049	5,450	482,00₺
S-6226-	650 - 680 x 470 x 160	700	1	0,057	6,150	521,00₺
S-6227-	750 - 780 x 470 x 160	800	1	0,066	6,650	555,00₺
S-6228-	850 - 880 x 470 x 160	900	1	0,074	7,350	590,00₺



Teleskopik Raylı Alüminyum Çekmeceli Pantolonluk
Aluminium Drawer and Trousler Rack with Telescopic Rail

Renk Seçenekleri
Color Options

S-XXXX-G
GREY

S-XXXX-A
ANTHRACITE

Ürün Kodu	W x D x H (mm)	C (mm)	Koli	Hacim (m ³)	Ağırlık kg.	Fiyat
S-6241-	650 - 680 x 470 x 160	700	1	0,057	5,200	462,00₺
S-6242-	750 - 780 x 470 x 160	800	1	0,066	5,650	493,00₺
S-6243-	850 - 880 x 470 x 160	900	1	0,074	6,150	535,00₺



Teleskopik Raylı Alüminyum Ayakkabılık
Aluminium Shoe Holder with Telescopic Rail

Renk Seçenekleri
Color Options

S-XXXX-G
GREY

S-XXXX-A
ANTHRACITE

Ürün Kodu	W x D x H (mm)	C (mm)	Koli	Hacim (m ³)	Ağırlık kg.	Fiyat
S-6261-	550 - 580 x 470 x 170	600	1	0,049	4,750	409,00₺
S-6262-	650 - 680 x 470 x 170	700	1	0,057	5,150	420,00₺
S-6263-	750 - 780 x 470 x 170	800	1	0,066	5,550	435,00₺
S-6264-	850 - 880 x 470 x 170	900	1	0,074	6,150	451,00₺



Pantolon Askılı Alüminyum 2 Sepetli Raylı Takım
Aluminium Trousler Rack 2 Shelves Set with Rail

Renk Seçenekleri
Color Options

S-XXXX-G
GREY

Ürün Kodu	W x D x H (mm)	Yön Direction	Koli	Hacim (m ³)	Ağırlık kg.	Fiyat
S-6082-	280 x 485 x 1120	Sol-Left	1	0,101	7,600	678,00₺
S-6083-	280 x 485 x 1120	Sağ-Right	1	0,101	7,600	678,00₺



3 Rafalı Alüminyum Ünite
Aluminium Unit with 3 Shelves

Renk Seçenekleri
Color Options

S-XXXX-G
GREY

Ürün Kodu	W x D x H (mm)	Yön Direction	Koli	Hacim (m ³)	Ağırlık kg.	Fiyat
S-6271-	280 x 485 x 920	Sol-Left	1	0,097	8,750	820,00₺
S-6272-	280 x 485 x 920	Sağ-Right	1	0,097	8,750	820,00₺



2 Rafly Raylı Alüminyum Ayakkabılık
Aluminium Shoe Holder with 2 Shelves

Renk Seçenekleri
Color Options

S-XXXX-G
GREY

S-XXXX-A
ANTHRACITE

Ürün Kodu	W x D x H (mm)	Yön Direction	Koli	Hacim (m ³)	Ağırlık kg.	Fiyat
S-6281-	300 x 470 x 520	Sol-Left	1	0,041	4,950	390,00₺
S-6282-	300 x 470 x 520	Sağ-Right	1	0,041	4,950	390,00₺

06

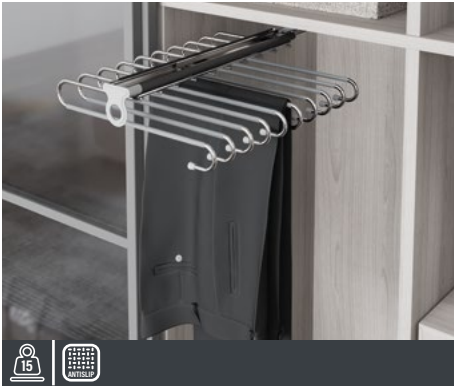

Tavan Bağlantılı Raylı Pantolon Askısı
Trousler Rack with Ceiling Mounted Rail

Renk Seçenekleri
Color Options

S-XXXX-G
GREY

S-XXXX-A
ANTHRACITE

Ürün Kodu	W x D x H (mm)	Koli	Hacim (m ³)	Ağırlık kg.	Fiyat
S-6545-	340 x 460 x 112	1	0,178	3,320	197,00₺

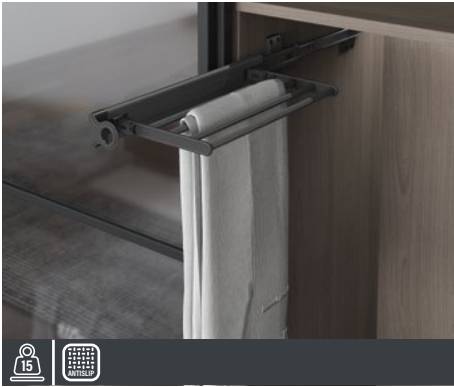

Raylı Alüminyum Pantolon Askısı
Aluminium Trousler Rack with Rail

Renk Seçenekleri
Color Options

S-XXXX-G
GREY

S-XXXX-A
ANTHRACITE

Ürün Kodu	W x D x H (mm)	Koli	Hacim (m ³)	Ağırlık kg.	Fiyat
S-6539-	215 x 460 x 90	10	0,171	14,550	126,00₺

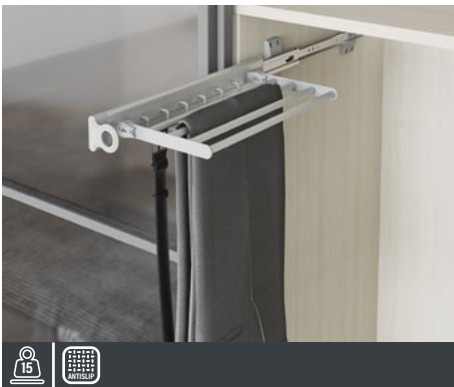

Raylı Alüminyum Pantolonluk Askılı Kemerlik
Aluminium Belt and Trousler Rack with Rail

Renk Seçenekleri
Color Options

S-XXXX-G
GREY

S-XXXX-A
ANTHRACITE

Ürün Kodu	W x D x H (mm)	Yön Direction	Koli	Hacim (m ³)	Ağırlık kg.	Fiyat
S-6540-	215 x 460 x 90	Sol-Left	10	0,149	14,500	126,00₺
S-6550-	215 x 460 x 90	Sağ-Right	10	0,149	14,500	126,00₺

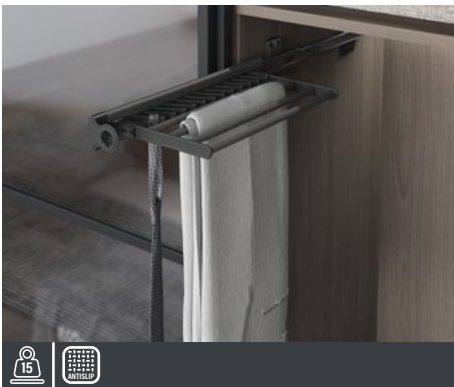

Raylı Alüminyum Pantolonluk Askılı Kravatlık
Aluminium Tie and Trousler Rack with Rail

Renk Seçenekleri
Color Options

S-XXXX-G
GREY

S-XXXX-A
ANTHRACITE

Ürün Kodu	W x D x H (mm)	Koli	Hacim (m ³)	Ağırlık kg.	Fiyat
S-6546-	215 x 460 x 90	10	0,149	14,550	126,00₺

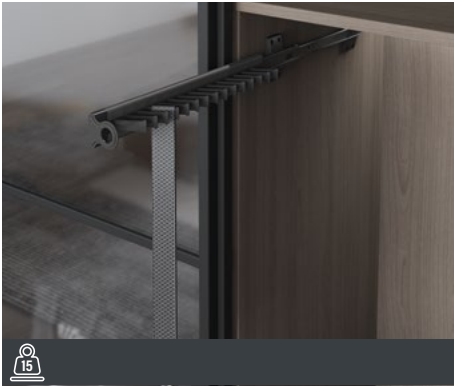
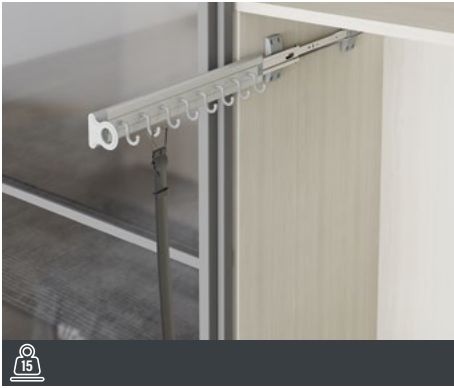
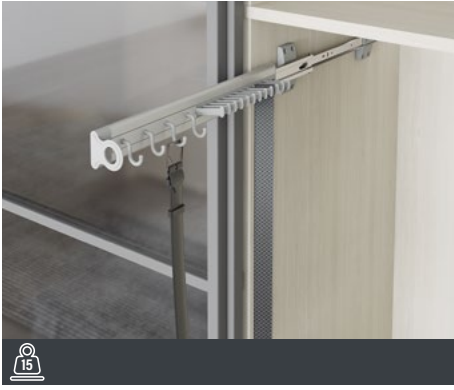

Raylı Alüminyum Kravatlık-Kemerlik Aluminium Tie-Belt Rack with Rail

Renk Seçenekleri
Color Options

S-XXXX-G
GREY

S-XXXX-A
ANTHRACITE

Ürün Kodu	W x D x H (mm)	Yön Direction	Koli	Hacim (m ³)	Ağırlık kg.	Fiyat
S-6544-	85 x 460 x 90	Sol-Left	10	0,047	12,150	119,00₺
S-6555-	85 x 460 x 90	Sağ-Right	10	0,047	12,150	119,00₺

Raylı Alüminyum Kemerlik Aluminium Belt Rack with Rail

Renk Seçenekleri
Color Options

S-XXXX-G
GREY

S-XXXX-A
ANTHRACITE

Ürün Kodu	W x D x H (mm)	Yön Direction	Koli	Hacim (m ³)	Ağırlık kg.	Fiyat
S-6541-	85 x 460 x 90	Sol-Left	10	0,470	9,930	99,00₺
S-6543-	85 x 460 x 90	Sağ-Right	10	0,470	9,930	99,00₺

Raylı Alüminyum Kravatlık Aluminium Tie Rack with Rail

Renk Seçenekleri
Color Options

S-XXXX-G
GREY

S-XXXX-A
ANTHRACITE

Ürün Kodu	W x D x H (mm)	Koli	Hacim (m ³)	Ağırlık kg.	Fiyat
S-6542-	85 x 460 x 90	10	0,047	10,350	100,00₺

Gömlek ve Havlu Askısı Shirt and Towel Rack

Renk Seçenekleri
Color Options

S-XXXX-C
CHROME

S-XXXX-A
ANTHRACITE

Ürün Kodu	W x D x H (mm)	Koli	Hacim (m ³)	Ağırlık kg.	Fiyat
S-6071-	50 x 300 x 60	20	0,016	10,050	32,00₺
S-6072-	50 x 350 x 60	20	0,016	11,650	33,20₺
S-6073-	50 x 400 x 60	20	0,016	13,000	35,00₺
S-6074-	50 x 450 x 60	20	0,016	14,950	38,00₺

Teleskopik Raylı Çok Amaçlı Sepet (Büyük Boy) Wire Shelf with Telescopic Rail (Large)

Renk Seçenekleri
Color Options

S-XXXX-C
CHROME

S-XXXX-A
ANTHRACITE

Ürün Kodu	W x D x H (mm)	C (mm)	Koli	Hacim (m ³)	Ağırlık kg.	Fiyat
S-6361-	355 - 375 x 465 x 360	400	1	0,064	2,390	318,00₺
S-6362-	405 - 425 x 465 x 360	450	1	0,073	2,570	333,00₺
S-6363-	455 - 475 x 465 x 360	500	1	0,081	2,760	347,00₺
S-6364-	505 - 525 x 465 x 360	550	1	0,090	2,950	364,00₺
S-6365-	555 - 575 x 465 x 360	600	1	0,099	3,140	379,00₺
S-6366-	655 - 675 x 465 x 360	700	1	0,116	3,500	405,00₺
S-6367-	755 - 775 x 465 x 360	800	1	0,134	3,890	432,00₺
S-6368-	855 - 875 x 465 x 360	900	1	0,152	4,260	464,00₺



Teleskopik Raylı Çok Amaçlı Sepet (Orta Boy)
Wire Shelf with Telescopic Rail (Medium)

Renk Seçenekleri
Color Options

S-XXXX-C
CHROME

S-XXXX-A
ANTHRACITE

Ürün Kodu	W x D x H (mm)	C (mm)	Koli	Hacim (m ³)	Ağırlık kg.	Fiyat
S-6351-	355 - 375 x 465 x 180	400	1	0,032	1,870	293,00₺
S-6352-	405 - 425 x 465 x 180	450	1	0,037	2,000	309,00₺
S-6353-	455 - 475 x 465 x 180	500	1	0,042	2,150	323,00₺
S-6354-	505 - 525 x 465 x 180	550	1	0,046	2,300	338,00₺
S-6355-	555 - 575 x 465 x 180	600	1	0,050	2,450	366,00₺
S-6356-	655 - 675 x 465 x 180	700	1	0,060	2,750	391,00₺
S-6357-	755 - 775 x 465 x 180	800	1	0,065	3,050	416,00₺
S-6358-	855 - 875 x 465 x 180	900	1	0,078	3,340	447,00₺



Teleskopik Raylı Çok Amaçlı Sepet (Küçük Boy)
Wire Shelf with Telescopic Rail (Small)

Renk Seçenekleri
Color Options

S-XXXX-C
CHROME

S-XXXX-A
ANTHRACITE

Ürün Kodu	W x D x H (mm)	C (mm)	Koli	Hacim (m ³)	Ağırlık kg.	Fiyat
S-6341-	355 - 375 x 465 x 70	400	1	0,013	1,550	258,00₺
S-6342-	405 - 425 x 465 x 70	450	1	0,015	1,650	277,00₺
S-6343-	455 - 475 x 465 x 70	500	1	0,017	1,770	281,00₺
S-6344-	505 - 525 x 465 x 70	550	1	0,019	1,900	304,00₺
S-6345-	555 - 575 x 465 x 70	600	1	0,021	2,020	321,00₺
S-6346-	655 - 675 x 465 x 70	700	1	0,025	2,300	344,00₺
S-6347-	755 - 775 x 465 x 70	800	1	0,029	2,520	366,00₺
S-6348-	855 - 875 x 465 x 70	900	1	0,032	2,770	394,00₺

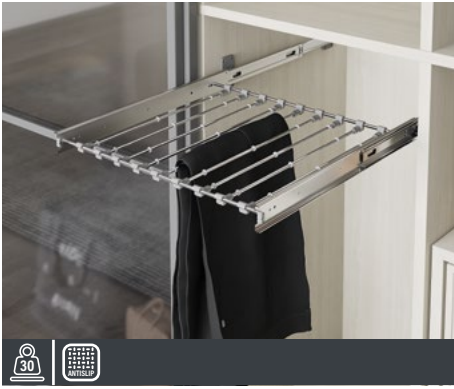

Teleskopik Raylı Pantolonluk
Trousler Rack with Telescopic Rail

Renk Seçenekleri
Color Options

S-XXXX-C
CHROME

S-XXXX-A
ANTHRACITE

Ürün Kodu	W x D x H (mm)	C (mm)	Koli	Hacim (m ³)	Ağırlık kg.	Fiyat
S-6023-	364 x 500 x 45	400	1	0,004	2,450	184,00₺
S-6024-	414 x 500 x 45	450	1	0,004	2,600	186,00₺
S-6025-	464 x 500 x 45	500	1	0,004	2,700	188,00₺
S-6026-	514 x 500 x 45	550	1	0,004	2,900	194,00₺
S-6027-	564 x 500 x 45	600	1	0,004	3,000	196,00₺



Gizli Raylı Çekmece ve Ayakkabılık Ünitesi
Drawer and Shoe Holder Unit with Undermount Rail

Renk Seçenekleri
Color Options

S-XXXX-C
CHROME

S-XXXX-A
ANTHRACITE

Ürün Kodu	W x D x H (mm)	Koli	Hacim (m ³)	Ağırlık kg.	Fiyat
S-6121-	450 x 485 x 510	1	0,125	10,800	884,00₺
S-6122-	500 x 485 x 510	1	0,133	11,200	904,00₺
S-6123-	550 x 485 x 510	1	0,146	11,700	920,00₺
S-6124-	600 x 485 x 510	1	0,172	12,220	936,00₺



Altın Raylı Ayakkabılık
Shoe Holder with Bottom Rail

Renk Seçenekleri
Color Options

S-XXXX-C
CHROME

S-XXXX-A
ANTHRACITE

Ürün Kodu	W x D x H (mm)	Koli	Hacim (m ³)	Ağırlık kg.	Fiyat
S-6101-	375 x 485 x 150	1	0,032	3,900	216,00₺
S-6102-	425 x 485 x 150	1	0,036	4,050	220,00₺
S-6103-	475 x 485 x 150	1	0,040	4,200	230,00₺
S-6104-	525 x 485 x 150	1	0,045	4,400	238,00₺



Tek Rafılı Kapağa Monte Ayakkabılık

Shoe Holder with One Shelf Mounted to Lid

Renk Seçenekleri
Color Options



Ürün Kodu	W x D x H (mm)	C (mm)	Koli	Hacim (m ³)	Ağırlık kg.	Fiyat
S-6131-	530 x 120 x 220	600	10	0,022	8,350	63,00₺
S-6132-	630 x 120 x 220	700	10	0,026	9,500	68,00₺
S-6133-	730 x 120 x 220	800	10	0,030	11,750	73,00₺
S-6134-	830 x 120 x 220	900	10	0,034	12,000	80,00₺



İki Rafılı Kapağa Monte Ayakkabılık

Shoe Holder with Two Shelves Mounted to Lid

Renk Seçenekleri
Color Options



Ürün Kodu	W x D x H (mm)	C (mm)	Koli	Hacim (m ³)	Ağırlık kg.	Fiyat
S-6141-	530 x 230 x 220	600	10	0,029	15,950	95,00₺
S-6142-	630 x 230 x 220	700	10	0,034	18,250	102,00₺
S-6143-	730 x 230 x 220	800	10	0,039	20,700	107,00₺
S-6144-	830 x 230 x 220	900	10	0,044	22,900	112,00₺



Ayakkabı Askısı

Shoe Holder

Renk Seçenekleri
Color Options



Ürün Kodu	W x D x H (mm)	Koli	Hacim (m ³)	Ağırlık kg.	Fiyat
S-6111-	420 - 700 x 200 x 95	20	0,027	13,800	51,00₺
S-6112-	820 - 1100 x 200 x 95	20	0,044	17,700	66,00₺



Gazetelik

Newspaper Holder

Renk Seçenekleri
Color Options



Ürün Kodu	W x D x H (mm)	Koli	Hacim (m ³)	Ağırlık kg.	Fiyat
S-6401-	375 x 270 x 430	1	0,071	3,200	101,00₺

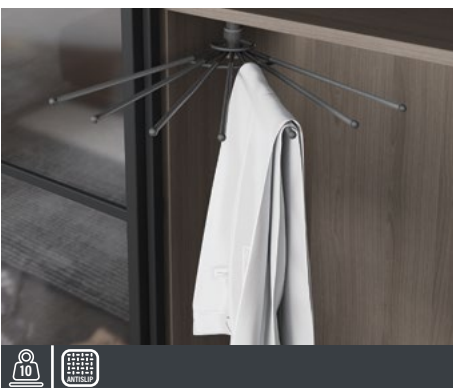

Döner Pantolonluk

Turning Trouser Rack

Renk Seçenekleri
Color Options



Ürün Kodu	W x D x H (mm)	Koli	Hacim (m ³)	Ağırlık kg.	Fiyat
S-6031-	460 x 460 x 80	10	0,178	18,500	127,00₺



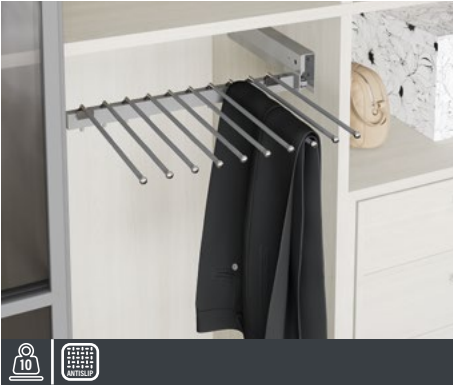

Raylı Pantolon Askısı
Trousers Rack with Rail

Renk Seçenekleri
Color Options

S-XXXX-G
GREY

S-XXXX-A
ANTHRACITE

Ürün Kodu	W x D x H (mm)	Koli	Hacim (m ³)	Ağırlık kg.	Fiyat
S-6035-	500 x 420 x 90	10	0,046	29,700	296,00₺



Raylı Kravatlık - Kemerlik
Tie - Belt Rack with Rail

Renk Seçenekleri
Color Options

S-XXXX-C
CHROME

S-XXXX-A
ANTHRACITE

Ürün Kodu	W x D x H (mm)	Yön Direction	Koli	Hacim (m ³)	Ağırlık kg.	Fiyat
S-6057-	120 x 460 x 110	Sağ-Right	12	0,073	16,000	111,00₺
S-6060-	120 x 460 x 110	Sol-Left	12	0,073	16,000	111,00₺



Raylı Kravatlık
Tie Rack with Rail

Renk Seçenekleri
Color Options

S-XXXX-C
CHROME

S-XXXX-A
ANTHRACITE

Ürün Kodu	W x D x H (mm)	Yön Direction	Koli	Hacim (m ³)	Ağırlık kg.	Fiyat
S-6056-	120 x 460 x 85	Sağ-Right	12	0,065	18,750	111,00₺
S-6059-	120 x 460 x 85	Sol-Left	12	0,065	18,750	111,00₺



Raylı Kemerlik
Belt Rack with Rail

Renk Seçenekleri
Color Options

S-XXXX-C
CHROME

S-XXXX-A
ANTHRACITE

Ürün Kodu	W x D x H (mm)	Yön Direction	Koli	Hacim (m ³)	Ağırlık kg.	Fiyat
S-6058-	120 x 460 x 110	Sağ-Right	12	0,073	18,750	111,00₺
S-6065-	120 x 460 x 110	Sol-Left	12	0,073	18,750	111,00₺

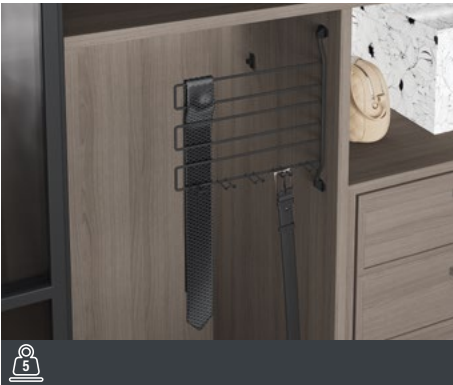

Menteşeli Kravatlık - Kemerlik
Tie - Belt Rack with Hinge

Renk Seçenekleri
Color Options

S-XXXX-C
CHROME

S-XXXX-A
ANTHRACITE

Ürün Kodu	W x D x H (mm)	Koli	Hacim (m ³)	Ağırlık kg.	Fiyat
S-6054-	350 x 50 x 350	10	0,109	7,900	55,00₺



Döner Masa Takımı Turning Table Set

Renk Seçenekleri
Color Options

S-XXXX-C
CHROME

Ürün Kodu	Takımı Oluşturan Ürünler Contents of Products	2 Koli	Hacim (m ³)	Ağırlık kg.	Fiyat
S-7001-	2 Adet Hasır Tabanlı Döner Sepet / Wire Turning Basket (2) 1 Adet Köşe Döner Sepet / Corner Turning Basket 1 Adet Boru Destek Parçası / Tube Support Item 1 Adet Döner Maşa Flaşısı / Turning Table Element 2 Adet Masa Ayağı H: 730 mm / Table Leg (2) 1 Adet Masa Ayak Tutucu / Table Leg Support 1 Adet Ø51 x 2150 Boru / Ø51 x 2150 Tube 1 Takım Boru Bağlantı Flaşısı / Tube Connection Element (1 Set)	1	0,065	12,980	1.010,00₺



Bar Takımı Bar Set

Renk Seçenekleri
Color Options

S-XXXX-C
CHROME

Ürün Kodu	Takımı Oluşturan Ürünler Contents of Products	2 Koli	Hacim (m ³)	Ağırlık kg.	Fiyat
S-7011-	Döner Kadeh Askısı / Turning Glass Rack Döner Şişelik / Corner Bottle Holder Ayaklık / Foot Rest 1 Adet Döner Maşa Flaşısı / Turning Table Element 1 Adet Ø51 x 2150 Boru / Ø51 x 2150 Tube 1 Takım Boru Bağlantı Flaşısı / Tube Connection Element (1 Set)	1	0,071	8,200	640,00₺



2 Cam Rafı Takım Set with 2 Glass Shelves

Renk Seçenekleri
Color Options

S-XXXX-C
CHROME

Ürün Kodu	Takımı Oluşturan Ürünler Contents of Products	Koli	Hacim (m ³)	Ağırlık kg.	Fiyat
S-7021-	2 Adet Cam Raf / Glass Shelf (2) 4 Adet Cam Raf Tutucu / Glass Shelf Support (4) 2 Adet Ø51 x 1300 Boru / Ø51 x 1300 Tube (2) 2 Takım Boru Bağlantı Flaşısı / Tube Connection Element (2 Sets)	1	0,049	21,320	1.137,00₺



3 Döner Sepetli Takım Set with 3 Turning Baskets

Renk Seçenekleri
Color Options

S-XXXX-C
CHROME

Ürün Kodu	Takımı Oluşturan Ürünler Contents of Products	Koli	Hacim (m ³)	Ağırlık kg.	Fiyat
S-7041-	1 Adet Şeffaf Plastik Tabanlı Döner Sepet Ø360 mm Transparent Plastic Bottom Turning Basket Ø360mm 1 Adet Hasır Tabanlı Döner Sepet Ø360 mm Wire Turning Basket Ø360mm 1 Adet Plastik Tabanlı Döner Sepet Ø360 mm Plastic Bottom Turning Basket Ø360mm 1 Adet Ø51 x 1300 Boru Ø51 x 1300 Tube (2) 1 Takım Boru Bağlantı Flaşısı Tube Connection Element (2 Sets)	1	0,069	7,840	523,00₺



Vestiyer Takımı
Cloakroom Set

Renk Seçenekleri
Color Options **S-XXXX-C**
CHROME

Ürün Kodu	Takımı Oluşturan Ürünler Contents of Products	2 Koli	Hacim (m³)	Ağırlık kg.	Fiyat
S-7051-	Döner Askı Ø500 / Turning Rack Ø500 Döner Askı Ø250 / Turning Rack Ø250 Döner Şemsiyelik Ø250 / Turning Umbrella Stand Ø250 1 Adet Ø51 x 2150 Boru / Ø51 x 2150 Tube 1 Takım Boru Bağlantı Flaşı / Tube Connection Element (1 Set)	1	0,065	12,980	521,00₺

07



Boru Destek Parçası
Tube Support Item

Renk Seçenekleri
Color Options **S-XXXX-C**
CHROME

Ürün Kodu	W x D x H (mm)	Koli	Hacim (m³)	Ağırlık kg.	Fiyat
S-7108-	200 x 220 x 30	10	0,027	7,500	116,00₺



Hasır Tabanlı Döner Sepet
Wire Turning Basket

Renk Seçenekleri
Color Options **S-XXXX-C**
CHROME

Ürün Kodu	Ø x H (mm)	Koli	Hacim (m³)	Ağırlık kg.	Fiyat
S-7101-	360 x 60	10	0,152	13,500	134,00₺



Köşe Döner Sepet
Corner Turning Basket

Renk Seçenekleri
Color Options **S-XXXX-C**
CHROME

Ürün Kodu	W x D x H (mm)	Koli	Hacim (m³)	Ağırlık kg.	Fiyat
S-7104-	340 x 335 x 50	10	0,152	17,500	161,00₺



Şeffaf Tabanlı Döner Sepet
Transparent Plastic Bottom Turning Basket

Renk Seçenekleri
Color Options **S-XXXX-C**
CHROME

Ürün Kodu	Ø x H (mm)	Koli	Hacim (m³)	Ağırlık kg.	Fiyat
S-7102-	360 x 80	10	0,152	19,000	134,00₺



Plastik Tabanlı Döner Sepet
Plastic Bottom Turning Basket

Renk Seçenekleri
Color Options

S-XXXX-C
CHROME

Ürün Kodu	Ø x H (mm)	Koli	Hacim (m ³)	Ağırlık kg.	Fiyat
S-7103-	360 x 80	10	0,152	16,500	134,00₺



Döner Kadeh Askısı
Turning Glass Rack

Renk Seçenekleri
Color Options

S-XXXX-C
CHROME

Ürün Kodu	Ø x H (mm)	Koli	Hacim (m ³)	Ağırlık kg.	Fiyat
S-7105-	360 x 90	10	0,152	10,500	134,00₺

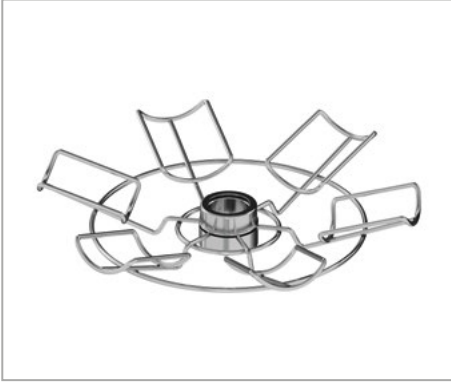

Döner Şişelik
Turning Bottle Holder

Renk Seçenekleri
Color Options

S-XXXX-C
CHROME

Ürün Kodu	Ø x H (mm)	Koli	Hacim (m ³)	Ağırlık kg.	Fiyat
S-7106-	460 x 100	10	0,271	18,500	174,00₺



Ayaklık
Foot Rest

Renk Seçenekleri
Color Options

S-XXXX-C
CHROME

Ürün Kodu	Ø x H (mm)	Koli	Hacim (m ³)	Ağırlık kg.	Fiyat
S-7107-	360 x 100	10	0,152	17,000	134,00₺

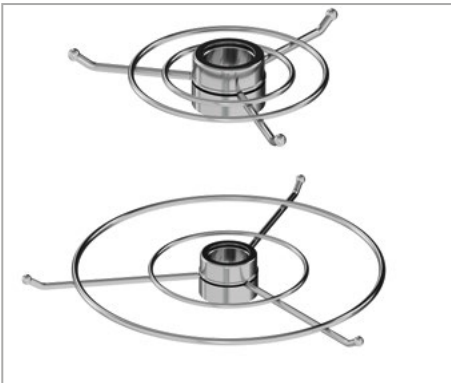

Döner Askı
Turning Rack

Renk Seçenekleri
Color Options

S-XXXX-C
CHROME

Ürün Kodu	Ø x H (mm)	Koli	Hacim (m ³)	Ağırlık kg.	Fiyat
S-7111-	250 x 50	10	0,152	0,700	68,00₺
S-7112-	500 x 50	10	0,178	1,250	79,00₺



Döner Şemsiyelik
Turning Stand for Umbrella

Renk Seçenekleri
Color Options

S-XXXX-C
CHROME

Ürün Kodu	Ø x H (mm)	Koli	Hacim (m³)	Ağırlık kg.	Fiyat
S-7113-	200 x 400	1	0,036	1,550	134,00₺

07



Hasır Tabanlı Kollu Döner Sepet
Wire Turning Basket with Arm

Renk Seçenekleri
Color Options

S-XXXX-C
CHROME

Ürün Kodu	Ø x H (mm)	Koli	Hacim (m³)	Ağırlık kg.	Fiyat
S-7114-	360 x 100	10	0,152	1,690	143,00₺



Ahşap Tabanlı Kollu Döner Sepet
Wooden Turning Basket with Arm

Renk Seçenekleri
Color Options

S-XXXX-C
CHROME

Ürün Kodu	Ø x H (mm)	Koli	Hacim (m³)	Ağırlık kg.	Fiyat
S-7115-	360 x 100	10	0,152	1,940	172,00₺



Ø51 mm Boru
Ø51 mm Tube

Renk Seçenekleri
Color Options

S-XXXX-C
CHROME

Ürün Kodu	Ø x H (mm)	Koli	Hacim (m³)	Ağırlık kg.	Fiyat
S-7201-	51 x 500	1	0,002	0,860	59,00₺
S-7202-	51 x 1000	1	0,004	1,750	107,00₺
S-7203-	51 x 1500	1	0,006	2,520	159,00₺
S-7204-	51 x 2000	1	0,007	3,360	214,00₺



Ø51 mm Boru Bağlantı Flaşı (Takım)
Ø51 mm Tube Connection Element (Set)

Renk Seçenekleri
Color Options

S-XXXX-C
CHROME

Ürün Kodu	Ø x H (mm)	Koli	Hacim (m³)	Ağırlık kg.	Fiyat
S-7231-	95 x 25	10	0,013	1,800	49,00₺



Oval Profil Tutucu - Takım (15x30 mm)
15x30 mm Oval Profile Fastener - Set

Renk Seçenekleri
Color Options

S-XXXX-C
CHROME

Ürün Kodu	Ø x H (mm)	Koli	Hacim (m³)	Ağırlık kg.	Fiyat
S-7232-	60 x 45	5	0,013	6,400	93,00₺



Tek Taraflı Raf Tutucu
Single Side Shelf Support

Renk Seçenekleri
Color Options

S-XXXX-C
CHROME

Ürün Kodu	W x D x H (mm)	Koli	Hacim (m³)	Ağırlık kg.	Fiyat
S-7241-	120 x 200 x 50	10	0,013	5,350	76,00₺

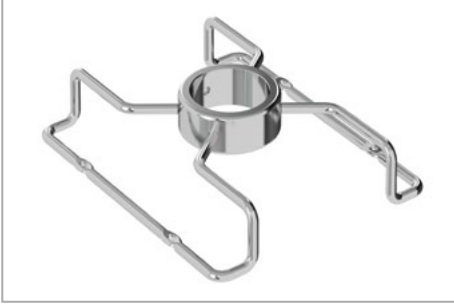

Çift Taraflı Raf Tutucu
Double Side Shelf Support

Renk Seçenekleri
Color Options

S-XXXX-C
CHROME

Ürün Kodu	W x D x H (mm)	Koli	Hacim (m³)	Ağırlık kg.	Fiyat
S-7242-	175 x 200 x 50	10	0,024	6,850	87,00₺



Açılı Bar Konsol Takımı
Angular Bar Console Set

Renk Seçenekleri
Color Options

S-XXXX-C
CHROME

Ürün Kodu	Ø x H (mm)	Bağlantı Türü	Koli	Hacim (m³)	Ağırlık kg.	Fiyat
S-7261-	51 x 200	Ahşap-Cam / Wooden-Glass	1	0,003	1,550	303,00₺
S-7262-	51 x 200	Ahşap-Ahşap / Wooden-Wooden	1	0,003	1,450	267,00₺



Düz Bar Konsol Takımı
Straight Bar Console Set

Renk Seçenekleri
Color Options

S-XXXX-C
CHROME

Ürün Kodu	Ø x H (mm)	Bağlantı Türü	Koli	Hacim (m³)	Ağırlık kg.	Fiyat
S-7263-	51 x 200	Ahşap-Cam / Wooden-Glass	1	0,003	1,700	328,00₺
S-7264-	51 x 200	Ahşap-Ahşap / Wooden-Wooden	1	0,003	1,600	301,00₺

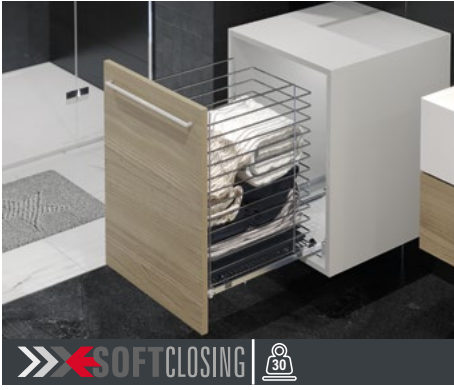

Gizli Raylı Çamaşır Sepeti
Laundry Basket with Undermount Rail

Renk Seçenekleri
Color Options

S-XXXX-C
CHROME

S-XXXX-A
ANTHRACITE

Ürün Kodu	W x D x H (mm)	C (mm)	Koli	Hacim (m ³)	Ağırlık kg.	Fiyat
S-8051-	240 x 470 x 550	300	1	0,051	7,500	655,00₺
S-8053-	340 x 470 x 550	400	1	0,073	8,000	699,00₺
S-8055-	440 x 470 x 550	500	1	0,101	9,500	774,00₺
S-8057-	540 x 470 x 550	600	1	0,127	10,000	821,00₺



Kapağa Monte Demonte Çamaşır Sepeti
Unassembled Laundry Basket Mounted to Lid

Renk Seçenekleri
Color Options

S-XXXX-C
CHROME

S-XXXX-A
ANTHRACITE

Ürün Kodu	W x D x H (mm)	C (mm)	Koli	Hacim (m ³)	Ağırlık kg.	Fiyat
S-8121-	230 x 260 x 500	300	1	0,005	1,400	102,00₺
S-8122-	280 x 260 x 500	350	1	0,005	1,540	107,00₺
S-8123-	330 x 260 x 500	400	1	0,006	1,700	115,00₺
S-8124-	380 x 260 x 500	450	1	0,007	1,800	120,00₺
S-8125-	430 x 260 x 500	500	1	0,008	1,900	126,00₺



Kapağa Monte Çamaşır Sepeti
Laundry Basket Mounted to Lid

Renk Seçenekleri
Color Options

S-XXXX-C
CHROME

S-XXXX-A
ANTHRACITE

Ürün Kodu	W x D x H (mm)	C (mm)	Koli	Hacim (m ³)	Ağırlık kg.	Fiyat
S-8011-	230 x 260 x 500	300	8	0,177	11,600	110,00₺
S-8012-	280 x 260 x 500	350	8	0,211	12,500	116,00₺
S-8013-	330 x 260 x 500	400	8	0,242	13,800	125,00₺
S-8014-	380 x 260 x 500	450	8	0,276	14,600	135,00₺
S-8015-	430 x 260 x 500	500	8	0,310	15,200	141,00₺



Askılı Çamaşır Sepeti
Laundry Basket with Hanger

Renk Seçenekleri
Color Options

S-XXXX-C
CHROME

S-XXXX-A
ANTHRACITE

Ürün Kodu	W x D x H (mm)	C (mm)	Koli	Hacim (m ³)	Ağırlık kg.	Fiyat
S-8111-	230 x 290 x 500	300	4	0,177	10,200	167,00₺
S-8112-	280 x 290 x 500	350	4	0,211	11,600	177,00₺
S-8113-	330 x 290 x 500	400	4	0,242	12,800	197,00₺
S-8114-	380 x 290 x 500	450	4	0,276	13,700	208,00₺
S-8115-	430 x 290 x 500	500	4	0,310	14,900	219,00₺
S-8116-	480 x 290 x 500	550	4	0,310	14,500	233,00₺
S-8117-	530 x 290 x 500	600	4	0,310	15,400	244,00₺



Kapak Rafli Banyo Sepeti
Bathroom Baskets with Lid Shelves

Renk Seçenekleri
Color Options

S-XXXX-C
CHROME

S-XXXX-A
ANTHRACITE

Ürün Kodu	W x D x H (mm)	C (mm)	Koli	Hacim (m ³)	Ağırlık kg.	Fiyat
S-8411-	250 x 300 x 560	350	1	0,034	3,700	328,00₺



Mini Döner Sepetli Banyo Seti Bathroom Set with Small Turning Baskets

Renk Seçenekleri
Color Options

S-XXXX-C
CHROME

S-XXXX-A
ANTHRACITE

Ürün Kodu	Ø x D x H (mm)	C (mm)	Koli	Hacim (m³)	Ağırlık kg.	Fiyat
S-8401-	250 x 300 x 550 - 650	350	1	0,027	4,850	694,00₺



5 Rafılı Döner Panel Revolving Panel with 5 Shelves

Renk Seçenekleri
Color Options

S-XXXX-C
CHROME

S-XXXX-A
ANTHRACITE

Ürün Kodu	Takımı Oluşturan Ürünler Contents of Products	Koli	Hacim (m³)	Ağırlık kg.	Fiyat
S-8421-	5 Adet Raf Çerçevesi Shelf Frame (5 pcs) 1 Adet Zemin Bağlantı Parçası Floor Fixing Part 1 Adet Duvar Bağlantı Parçası Wall Fixing Part	1	0,013	2,500	428,00₺



Klasik Döner Raf Classical Turning Shelf

Renk Seçenekleri
Color Options

S-XXXX-C
CHROME

S-XXXX-A
ANTHRACITE

Ürün Kodu	W x D x H (mm)	Koli	Hacim (m³)	Ağırlık kg.	Fiyat
S-8501-	280 x 150 x 145	10	0,029	7,340	50,00₺



Lüks Döner Raf Luxury Turning Shelf

Renk Seçenekleri
Color Options

S-XXXX-C
CHROME

S-XXXX-A
ANTHRACITE

Ürün Kodu	W x D x H (mm)	Koli	Hacim (m³)	Ağırlık kg.	Fiyat
S-8502-	280 x 150 x 145	10	0,029	10,600	67,00₺



Raf Bariyeri Barrier for Shelf

Renk Seçenekleri
Color Options

S-XXXX-C
CHROME

S-XXXX-A
ANTHRACITE

Ürün Kodu	W x D x H (mm)	Koli	Hacim (m³)	Ağırlık kg.	Fiyat
S-8601-	300 x 15 x 65	10	0,013	2,700	34,10₺
S-8602-	400 x 15 x 65	10	0,013	3,700	37,20₺
S-8603-	500 x 15 x 65	10	0,013	4,700	42,00₺



Raylı Havluluk
Towel Holder with Rail

Renk Seçenekleri
Color Options

S-XXXX-C
CHROME

S-XXXX-A
ANTHRACITE

Ürün Kodu	W x D x H (mm)	Koli	Division	Hacim (m ³)	Ağırlık kg.	Fiyat
S-8843-	500 x 70 x 40	25	1	0,0011	0,760	97,00₺
S-8844-	500 x 110 x 40	25	2	0,0017	1,035	100,00₺
S-8845-	500 x 150 x 40	25	3	0,0024	1,225	110,00₺



Kare Tel Sabunluk
Square Wire Soap Holder

Renk Seçenekleri
Color Options

S-XXXX-C
CHROME

S-XXXX-A
ANTHRACITE

Ürün Kodu	W x D x H (mm)	Material	Koli	Hacim (m ³)	Ağırlık kg.	Fiyat
S-8895-	140 x 85 x 35	Pirinç / Brass	1	0,0005	0,225	92,00₺



Oval Tel Sabunluk
Oval Wire Soap Holder

Renk Seçenekleri
Color Options

S-XXXX-C
CHROME

S-XXXX-A
ANTHRACITE

Ürün Kodu	W x D x H (mm)	Material	Koli	Hacim (m ³)	Ağırlık kg.	Fiyat
S-8896-	140 x 80 x 35	Pirinç / Brass	1	0,0005	0,235	88,00₺



Tekli Oval Köşe Süngerlik
Single Oval-Edge Sponge Holder

Renk Seçenekleri
Color Options

S-XXXX-C
CHROME

S-XXXX-A
ANTHRACITE

Ürün Kodu	W x D x H (mm)	Material	Koli	Hacim (m ³)	Ağırlık kg.	Fiyat
S-8862-	180 x 180 x 70	Pirinç / Brass	1	0,0023	0,435	150,00₺
S-8863-	220 x 220 x 70	Pirinç / Brass	1	0,0028	0,500	178,00₺



İkili Oval Köşe Süngerlik
Double Oval-Edge Sponge Holder

Renk Seçenekleri
Color Options

S-XXXX-C
CHROME

S-XXXX-A
ANTHRACITE

Ürün Kodu	W x D x H (mm)	Material	Koli	Hacim (m ³)	Ağırlık kg.	Fiyat
S-8865-	180 x 180 x 350	Pirinç / Brass	1	0,0115	1,010	305,00₺
S-8866-	220 x 220 x 350	Pirinç / Brass	1	0,0132	1,145	325,00₺



Üçlü Oval Köşe Süngerlik
Triple Oval-Edge Sponge Holder

Renk Seçenekleri
Color Options

S-XXXX-C
CHROME

S-XXXX-A
ANTHRACITE

Ürün Kodu	W x D x H (mm)	Material	Koli	Hacim (m ³)	Ağırlık kg.	Fiyat
S-8868-	180 x 180 x 630	Pirinç / Brass	1	0,0200	1,555	430,00₺
S-8869-	220 x 220 x 630	Pirinç / Brass	1	0,0221	1,675	475,00₺



Tekli Açık Köşe Süngerlik
Single Open-Edge Sponge Holder

Renk Seçenekleri
Color Options

S-XXXX-C
CHROME

S-XXXX-A
ANTHRACITE

Ürün Kodu	W x D x H (mm)	Material	Koli	Hacim (m ³)	Ağırlık kg.	Fiyat
S-8852-	180 x 180 x 70	Pirinç / Brass	1	0,0016	0,350	129,00₺
S-8853-	220 x 220 x 70	Pirinç / Brass	1	0,0024	0,430	160,00₺



İkili Açık Köşe Süngerlik
Double Open-Edge Sponge Holder

Renk Seçenekleri
Color Options

S-XXXX-C
CHROME

S-XXXX-A
ANTHRACITE

Ürün Kodu	W x D x H (mm)	Material	Koli	Hacim (m ³)	Ağırlık kg.	Fiyat
S-8855-	180 x 180 x 350	Pirinç / Brass	1	0,0132	0,860	263,00₺
S-8856-	220 x 220 x 350	Pirinç / Brass	1	0,0181	1,035	289,00₺



Üçlü Açık Köşe Süngerlik
Triple Open-Edge Sponge Holder

Renk Seçenekleri
Color Options

S-XXXX-C
CHROME

S-XXXX-A
ANTHRACITE

Ürün Kodu	W x D x H (mm)	Material	Koli	Hacim (m ³)	Ağırlık kg.	Fiyat
S-8858-	180 x 180 x 630	Pirinç / Brass	1	0,0184	1,295	355,00₺
S-8859-	220 x 220 x 630	Pirinç / Brass	1	0,0259	1,515	453,00₺



Üçlü Açık Köşe Süngerlik (Ayaklı)
Triple Open-Edge Bathroom Storage Holder with Foot

Renk Seçenekleri
Color Options

S-XXXX-C
CHROME

S-XXXX-A
ANTHRACITE

Ürün Kodu	W x D x H (mm)	Material	Koli	Hacim (m ³)	Ağırlık kg.	Fiyat
S-8854-	220 x 220 x 680	Pirinç / Brass	1	0,036	1,650	548,00₺



Tekli Dikdörtgen Süngerlik
Single Rectangular Bathroom Storage Holder

Renk Seçenekleri
Color Options

S-XXXX-C
CHROME

S-XXXX-A
ANTHRACITE

Ürün Kodu	W x D x H (mm)	Material	Koli	Hacim (m ³)	Ağırlık kg.	Fiyat
S-8871-	230 x 175 x 70	Pirinç / Brass	1	0,004	0,450	163,00₺



İkili Dikdörtgen Süngerlik
Double Rectangular Bathroom Storage Holder

Renk Seçenekleri
Color Options

S-XXXX-C
CHROME

S-XXXX-A
ANTHRACITE

Ürün Kodu	W x D x H (mm)	Material	Koli	Hacim (m ³)	Ağırlık kg.	Fiyat
S-8872-	230 x 175 x 350	Pirinç / Brass	1	0,021	0,990	307,00₺



Üçlü Dikdörtgen Süngerlik
Triple Rectangular Bathroom Storage Holder

Renk Seçenekleri
Color Options

S-XXXX-C
CHROME

S-XXXX-A
ANTHRACITE

Ürün Kodu	W x D x H (mm)	Material	Koli	Hacim (m ³)	Ağırlık kg.	Fiyat
S-8873-	230 x 175 x 630	Pirinç / Brass	1	0,037	1,520	475,00₺

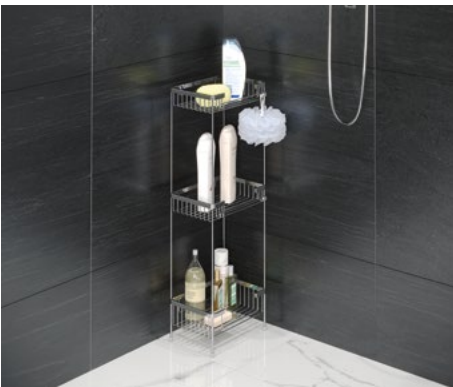

Üçlü Dikdörtgen Süngerlik (Ayaklı)
Triple Rectangular Bathroom Storage Holder with Foot

Renk Seçenekleri
Color Options

S-XXXX-C
CHROME

S-XXXX-A
ANTHRACITE

Ürün Kodu	W x D x H (mm)	Material	Koli	Hacim (m ³)	Ağırlık kg.	Fiyat
S-8874-	230 x 175 x 680	Pirinç / Brass	1	0,030	1,990	627,00₺



Ayaklı Tuvalet Kağıtlığı
Toilet Paper Holder with Foot

Renk Seçenekleri
Color Options

S-XXXX-C
CHROME

S-XXXX-A
ANTHRACITE

Ürün Kodu	W x D x H (mm)	Material	Koli	Hacim (m ³)	Ağırlık kg.	Fiyat
S-8834-	160 x 160 x 600	Pirinç / Brass	1	0,018	1,310	402,00₺



Sürme Kapak Sistemleri **Sliding Systems**



Sürme Kapı Sistemleri **Sliding Door Systems**



Aksesuar **Accessories**

09



Sürme Kapak Sistemi / Sliding System



Sürme Kapı Sistemi / Sliding Door System



Karma Üst Taşıyıcı / Combined Top Carrier



İçten Sistem / Internal System



Karma Alt Taşıyıcı / Combined Bottom Carrier



Dıştan Sistem / External System



Üst Taşıyıcı / Top Carrier



Ahşap - Cam / Wooden - Glass



Cam / Glass



Ahşap / Wooden



Tek Yön Yavaşlatıcı / Single Soft Closing



Çift Yön Yavaşlatıcı / Double Soft Closing



Panel Kalınlık / Panel Thickness



Ağırlık / Weight



Yatay Ayarlı / Horizontal Adjustable



Dikey Ayarlı / Vertical Adjustable



Kutu İçi Miktar / Box Quantity



Montaj Şeması / Mounting Instruction



Yağlı Piston Sistemi / Oil Damper System



Havalı Piston Sistemi / Air Damper System



Sürme Kapı Yandan / Side Mounted Sliding Door



Sürme Kapı Üstten / Top Mounted Sliding Door

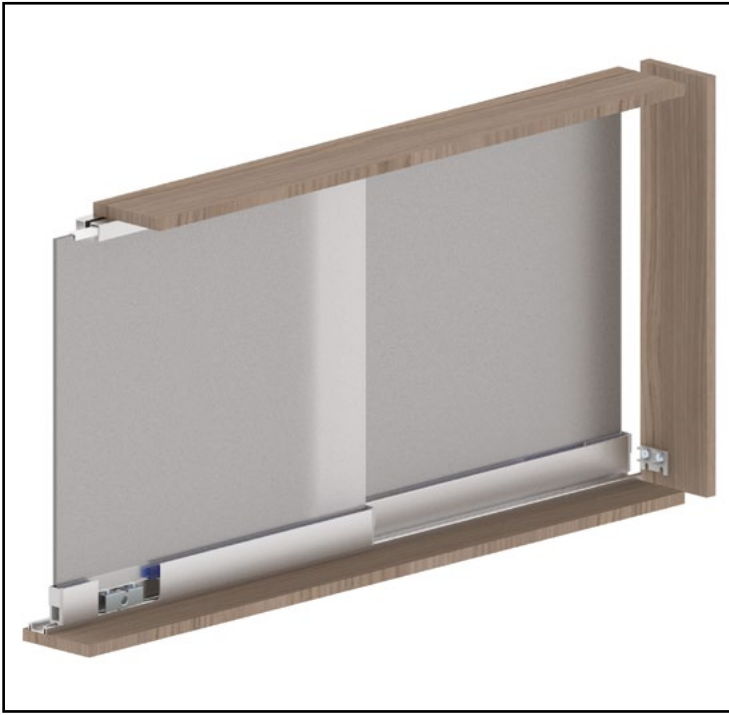

LC15

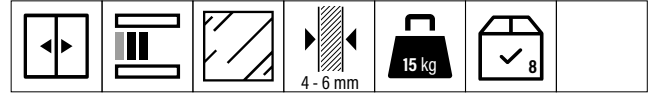

PDF

1 Set İçeriği | 1 Set Includes



Code	T (mm)	Box	Volume (m³)	Weight (kg)	Birim / Unit	Fiyat
L-1101	4-6	288	0,027	12,72	1Tk - 1 Kapak / 1 Set - 1 Doors	24,00₺

Technical Drawing	Code	T (mt)	Bağ Band	Volume (m³)	Weight (kg)	Unit	Fiyat
<p>Alüminyum Üst Ray / Upper Rail</p>	L-3101	3.00	15	0,0168	0,06240	Adet Pcs	62,00₺
<p>Alüminyum Gövde Rayı / Body Rail</p>	L-3102	3.00	10	0,0105	0,7710	Adet Pcs	77,00₺
<p>Alüminyum Alt Ray / Bottom Rail</p>	L-3103	3.00	30	0,012	0,4410	Adet Pcs	44,00₺
<p>Cam Dolgu Fıtlı / Thin Glass Roving</p>	L-3751	100	200	-	-	Mt	5,80₺

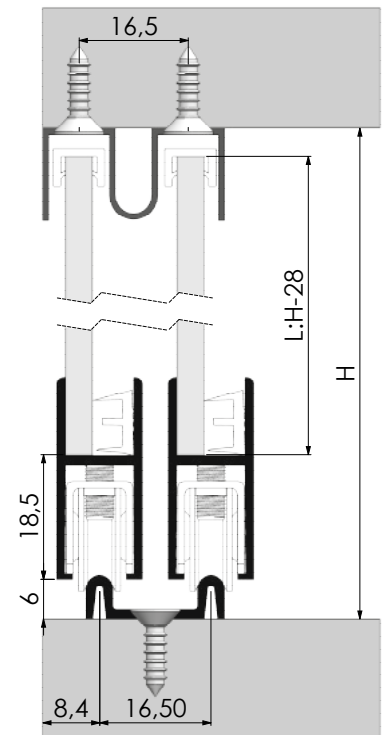

LC MIX 15

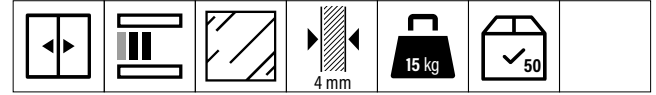

PDF

09

1 Set İeriđi | 1 Set Includes

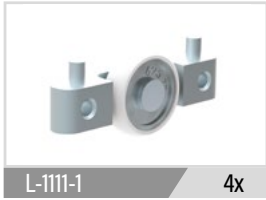

L-1111-1

4x

Code	T (mm)	Box	Volume (m ³)	Weight (kg)	Birim / Unit	Fiyat
L-1111	20	300	0,035	35,54	1Tk - 1 Kapak / 1 Set - 1 Doors	3700₺

Technical Drawing	Code	T (mt)	Bađ Band	Volume (m ³)	Weight (kg)	Unit	Fiyat
<p>Alüminyum Çereve Profili / Frame Profile</p>	L-3602	3.00	10	-	-	Adet Pcs	
<p>Alüminyum Çereve Profili / Frame Profile</p>	L-3605	3.00	10	-	-	Adet Pcs	
<p>Alüminyum Alt-Üst Ray / Bottom-Upper Rail</p>	L-3104	3.00	20	0,0135	0,300	Adet Pcs	41,00₺

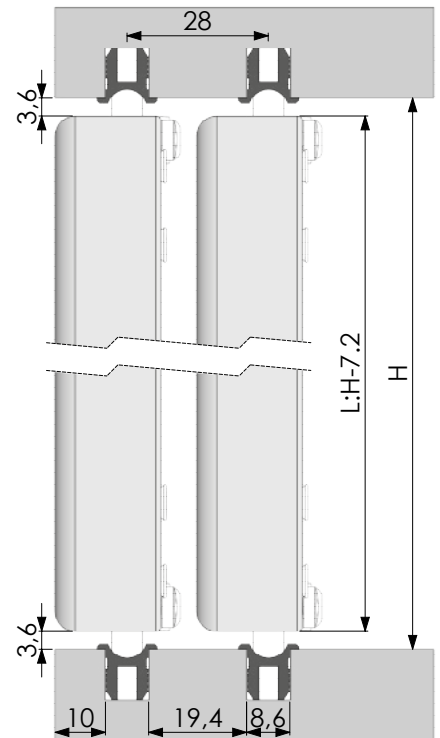



LC MIX 15 ADAPTÖRLÜ / WITH ADAPTER

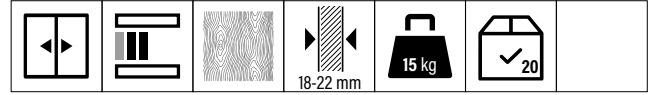

PDF

1 Set İçeriği | 1 Set Includes



L-1112-1

4x

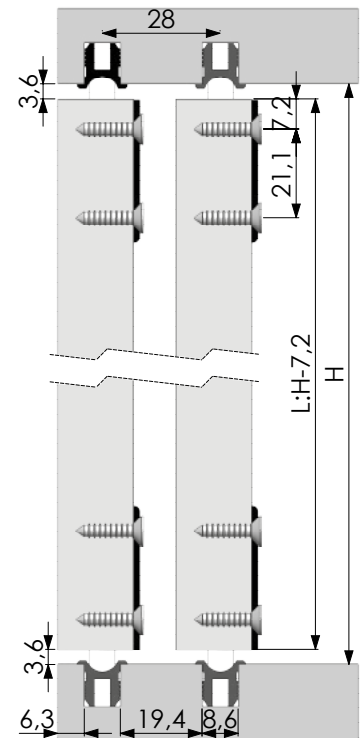

Code	T (mm)	Box	Volume (m³)	Weight (kg)	Birim / Unit	Fiyat
L-1112	18-22	120	0,035	32,98	1Tk -1 Kapak / 1 Set -1 Doors	55,00₺

Technical Drawing	Code	T (mt)	Bağ Band	Volume (m³)	Weight (kg)	Unit	Fiyat
<p>Alüminyum Alt-Üst Ray / Bottom-Upper Rail</p>	L-3104	3.00	20	0,0135	0,300	Adet Pcs	41,00₺

LC30

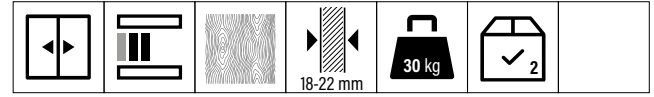

PDF

09

1 Set İeriđi | 1 Set Includes

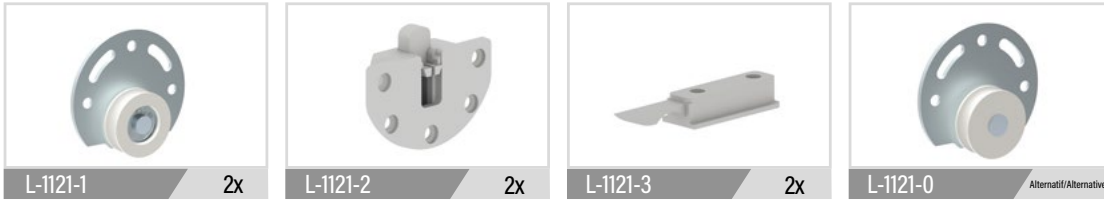

Code	T (mm)	Box	Volume (m ³)	Weight (kg)	Birim / Unit	Fiyat
L-1121	18-22	72	0,027	786	1 Tk - 1 Kapak / 1 Set - 1 Doors	13,70₺

Technical Drawing	Code	T (mm)	Bađ Band	Volume (m ³)	Weight (kg)	Unit	Fiyat
<p>PVC Üst Ray / Upper Rail</p>	L-3703	3.00	50	0,0225	0,200	Adet Pcs	11,40₺
<p>PVC Alt Ray / Bottom Rail</p>	L-3701	3.00	50	0,03375	0,165	Adet Pcs	9,50₺
<p>Alüminyum Alt Ray / Bottom Rail</p>	L-3106	3.00	50	0,3375	0,300	Adet Pcs	35,20₺

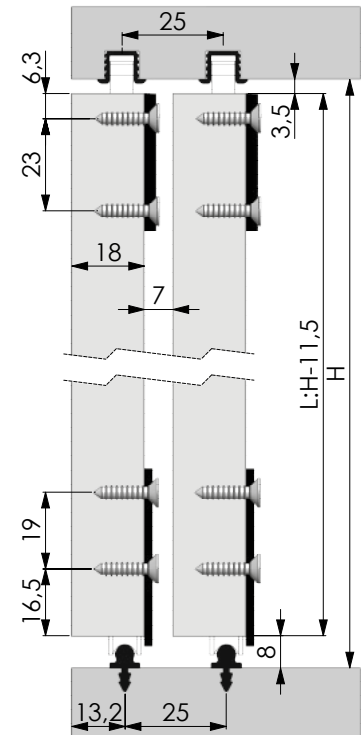



LC32

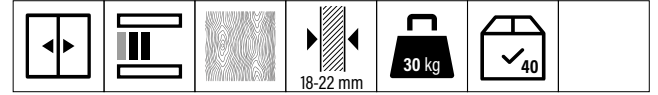

PDF

1 Set İeriđi | 1 Set Includes



L-1124-1

4x

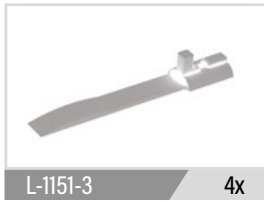

L-1151-3

4x

Code	T (mm)	Box	Volume (m ³)	Weight (kg)	Birim / Unit	Fiyat
L-1124	18-22	240	0,035	43	1Tk - 1 Kapak / 1 Set - 1 Doors	18,00₺

Technical Drawing	Code	T (mt)	Bađ Band	Volume (m ³)	Weight (kg)	Unit	Fiyat
<p>Alüminyum Tekli Alt-Üst Ray / Bottom-Upper Rail</p>	L-3112-3	2.00	40	0,014	0,250	Adet Pcs	36,20₺
	L-3112-1	2.50		0,018	0,312		46,00₺
	L-3112	3.00		0,022	0,350		54,00₺

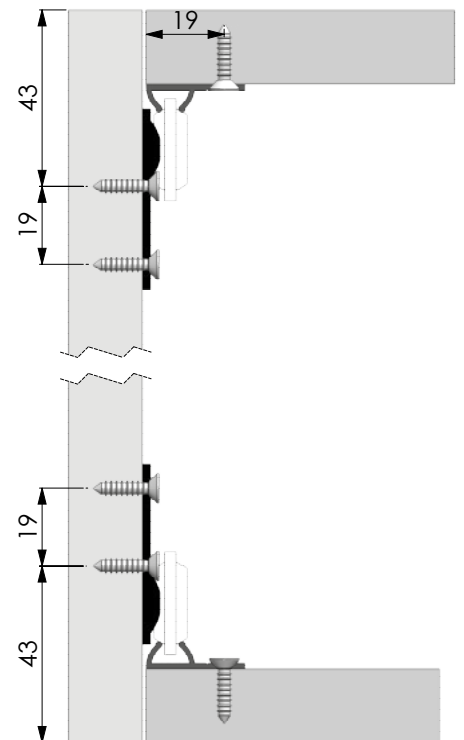

LC38 AY

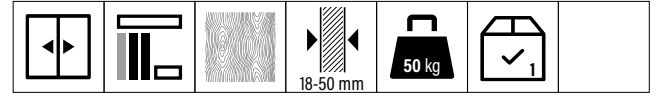

Bilgi / Information: L-1122 = İç Kapak / Inner Door
L-1123 = Dış Kapak / Outer Door



PDF

09

1 Set İçeriği | 1 Set Includes



Code	T (mm)	Box	Volume (m³)	Weight (kg)	Birim / Unit	Fiyat
L-1122	18-50	40	0,035	30,34	1Tk - 1 Kapak / 1 Set - 1 Doors	40,00₺
L-1123	18-50	40	0,035	38,13	1Tk - 1 Kapak / 1 Set - 1 Doors	46,00₺

Technical Drawing	Code	T (mt)	Bağ Band	Volume (m³)	Weight (kg)	Unit	Fiyat
<p>Alüminyum Üst Ray / Upper Rail</p>	L-3138	3.00	10	0,033	1,8690	Adet Pcs	186,00₺
<p>Alüminyum Alt Ray / Bottom Rail</p>	L-3108	3.00	10	0,0324	1,1760	Adet Pcs	116,00₺

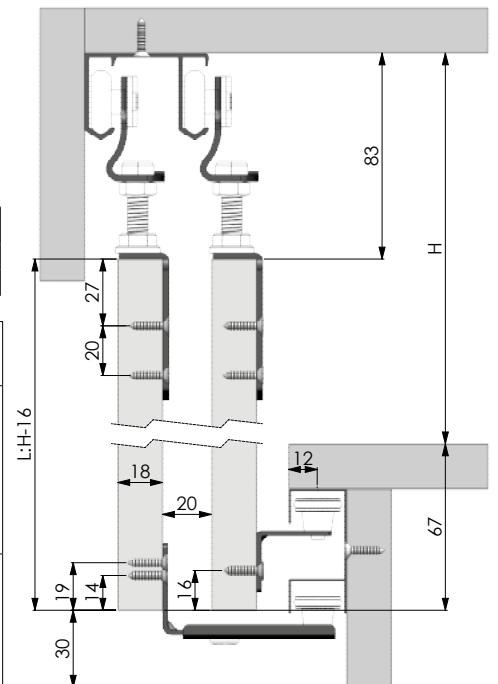



LC40

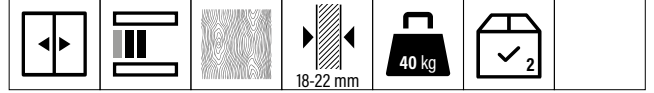

PDF

1 Set İeriđi | 1 Set Includes



Code	T (mm)	Box	Volume (m ³)	Weight (kg)	Birim / Unit	Fiyat
L-1125	18-22	72	0,027	11,32	1 Tk - 1 Kapak / 1 Set - 1 Doors	20,00₺

Technical Drawing	Code	T (mt)	Bađ Band	Volume (m ³)	Weight (kg)	Unit	Fiyat
<p>PVC Üst Ray / Upper Rail</p>	L-3703	3.00	50	0,0225	0,200	Adet Pcs	11,40₺
<p>Alüminyum Alt-Üst Ray / Bottom-Upper Rail</p>	L-3130	3.00	40	0,036	0,300	Adet Pcs	35,00₺

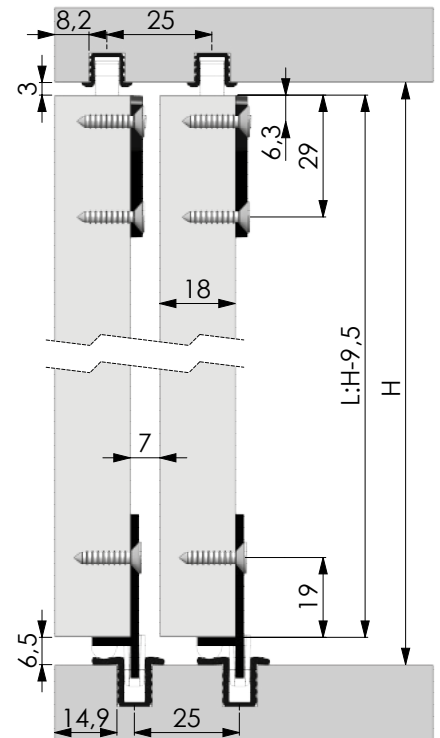

LC41

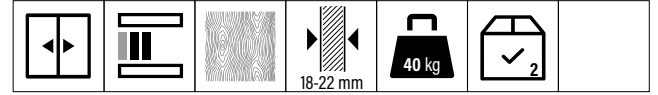

PDF

09

1 Set İçeriği | 1 Set Includes



L-1125-1 2x

L-1126-2 2x

L-1126-3 2x

Code	T (mm)	Box	Volume (m ³)	Weight (kg)	Birim / Unit	Fiyat
L-1126	18-22	72	0,027	13,1	1Tk -1 Kapak / 1Set -1 Doors	22,00₺

Technical Drawing	Code	T (mt)	Bağ Band	Volume (m ³)	Weight (kg)	Unit	Fiyat
<p>Alüminyum Alt-Üst Ray / Bottom-Upper Rail</p>	L-3130	3.00	40	0,036	0,300	Adet Pcs	35,00₺

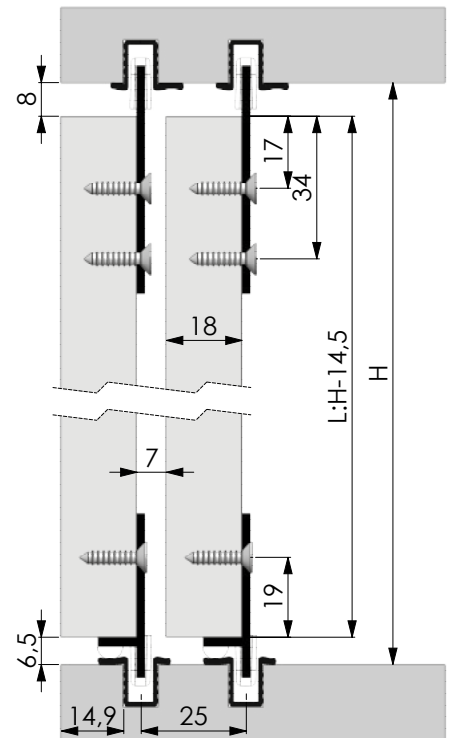



LC50 2P

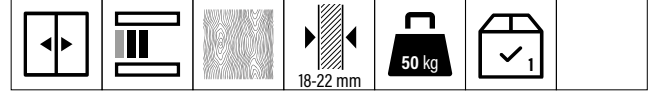

PDF

1 Set İçeriği | 1 Set Includes

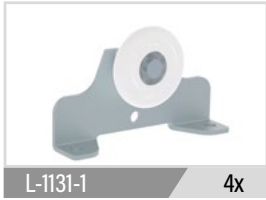

L-1134 3 Kapaklı Set / 3 Door Set



Code	T (mm)	Box	Volume (m³)	Weight (kg)	Birim / Unit	Fiyat
L-1131	18-22	40	0,035	14	1 Tk - 2 Kapak / 1 Set - 2 Doors	51,00₺
L-1134	18-22	28	0,035	18,3	1 Tk - 3 Kapak / 1 Set - 3 Doors	76,00₺

Technical Drawing	Code	T (mt)	Bağ Band	Volume (m³)	Weight (kg)	Unit	Fiyat
<p>PVC Üst Ray / Upper Rail</p>	L-3107	3.00	6	0,0195	1,3530	Adet Pcs	
<p>PVC Alt Ray / Bottom Rail</p>	L-3703	3.00	50	0,0225	0,200	Adet Pcs	11,40₺

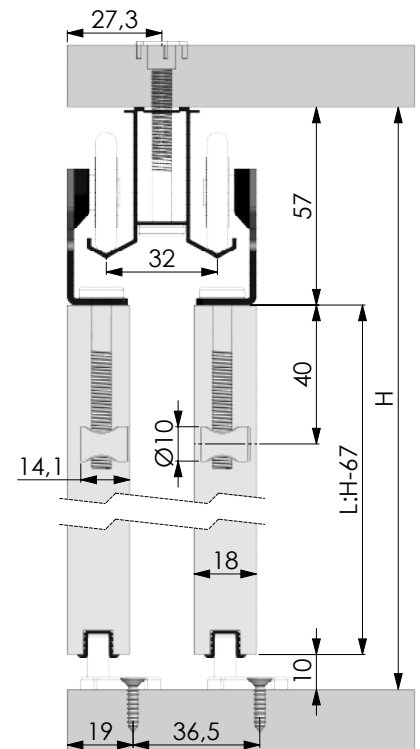

LC50 2M

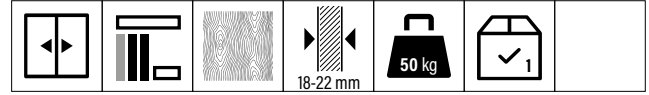

PDF

09

1 Set İçeriği | 1 Set Includes



L-1134 3 Kapaklı Set / 3 Door Set



Code	T (mm)	Box	Volume (m³)	Weight (kg)	Birim / Unit	Fiyat
L-1132	18-22	40	0,035	14	1Tk - 2 Kapak / 1Set - 2 Doors	65,00₺
L-1135	18-22	28	0,035	27,96	1Tk - 3 Kapak / 1Set - 3 Doors	94,00₺

Technical Drawing	Code	T (mt)	Bağ Band	Volume (m³)	Weight (kg)	Unit	Fiyat
<p>Alüminyum Üst Ray / Upper Rail</p>	L-3107	3.00	6	0,0195	1,3530	Adet Pcs	
<p>Alüminyum Alt Ray / Bottom Rail</p>	L-3108	3.00	10	0,0324	1,1760	Adet Pcs	116,00₺

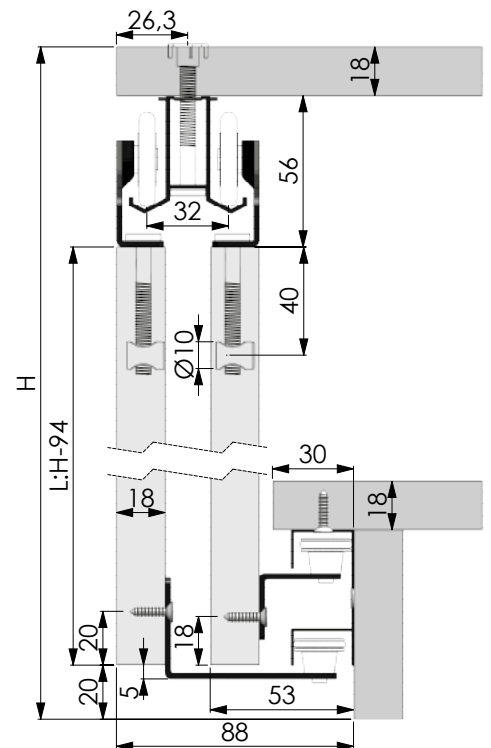



LC53

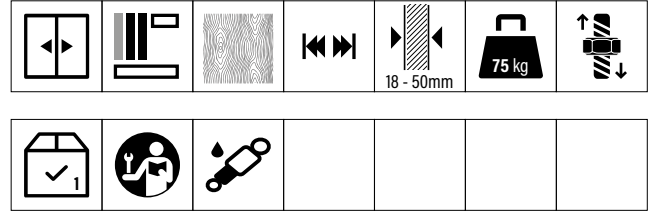

PDF

1 Set İçeriği | 1 Set Includes

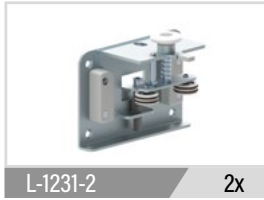
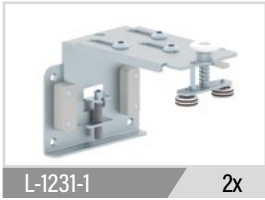

Code	T (mm)	Box	Volume (m ³)	Weight (kg)	Birim / Unit	Fiyat
L-1231	18-50	4	0,0361	15,54	1Tk - 2 Kapak / 1Set - 2 Doors	346,00₺
L-1232	18-50	4	0,0361	16,68	1Tk - 3 Kapak / 1Set - 3 Doors	460,00₺

Technical Drawing	Code	T (mt)	Bağ Band	Volume (m ³)	Weight (kg)	Unit	Fiyat
<p>Alüminyum Üst Ray / Upper Rail</p>	L-3173-1	2.00	4	0,0216	2,1000	Adet Pcs	206,00₺
	L-3173-2	2.50		0,027	2,6250		257,00₺
	L-3173-3	3.00		0,05106	2,800		308,00₺
<p>PVC Alt Ray / Bottom Rail</p>	L-3703	3.00	50	0,0225	0,200	Adet Pcs	11,40₺

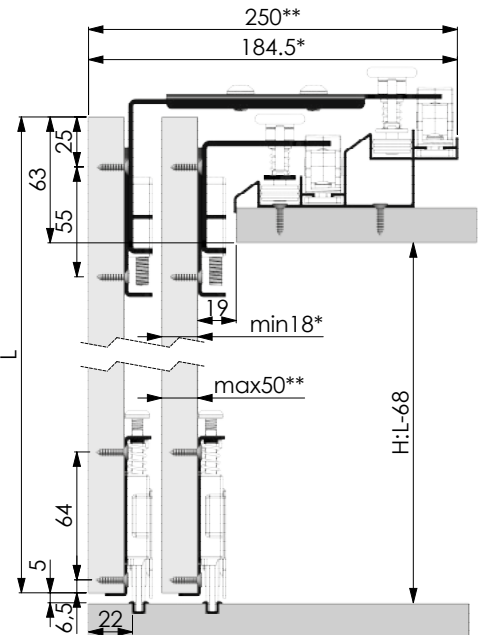

LC54 18-25 mm

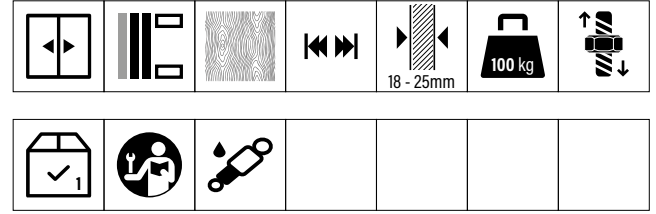

PDF

09

1 Set İçeriği | 1 Set Includes



Code	T (mm)	Box	Volume (m³)	Weight (kg)	Birim / Unit	Fiyat
L-1241	18-25	4	0,0361	15,46	1Tk - 2 Kapak / 1Set - 2 Doors	469,00₺
L-1244	18-25	4	0,0361	17	1Tk - 3 Kapak / 1Set - 3 Doors	668,00₺

Technical Drawing	Code	T (mt)	Bağ Band	Volume (m³)	Weight (kg)	Unit	Fiyat
<p>Alüminyum Üst Ray / Upper Rail</p>	L-3172-1	2.00	8	0,016	1,6240	Adet Pcs	163,00₺
	L-3172-2	2.50		0,02	2,000		204,00₺
	L-3172-3	3.00		0,0357	2,200		244,00₺
<p>Alüminyum Alt Ray / Bottom Rail</p>	L-3171-1	2.00	6	0,011	0,960	Adet Pcs	94,00₺
	L-3171-2	2.50		0,01375	1,200		118,00₺
	L-3171-3	3.00		0,03321	1,200		141,00₺

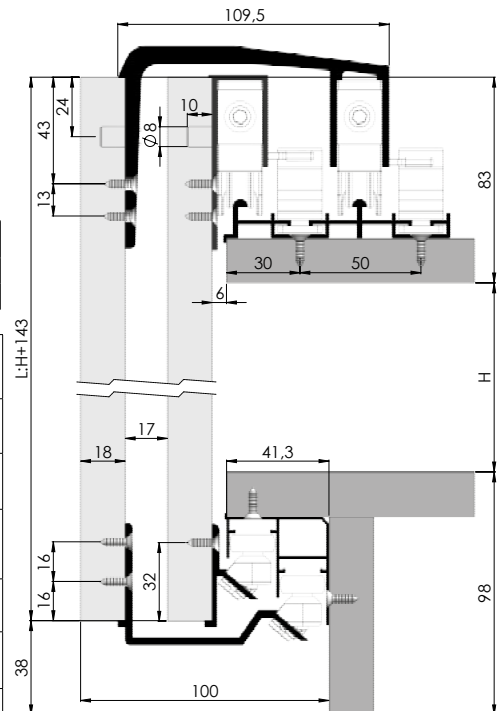



LC54 26-35 mm

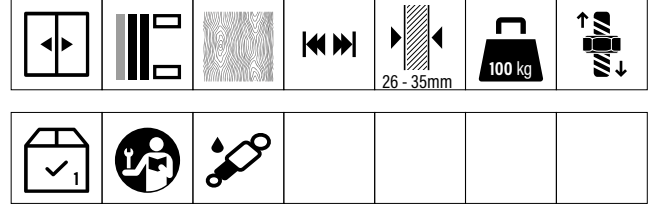

PDF

1 Set İçeriği | 1 Set Includes



Code	T (mm)	Box	Volume (m³)	Weight (kg)	Birim / Unit	Fiyat
L-1242	26-35	4	0,0361	17,26	1Tk - 2 Kapak / 1Set - 2 Doors	464,00₺
L-1245	26-35	4	0,0361	18,8	1Tk - 3 Kapak / 1Set - 3 Doors	668,00₺

Technical Drawing	Code	T (mt)	Bağ Band	Volume (m³)	Weight (kg)	Unit	Fiyat
<p>Alüminyum Üst Ray / Upper Rail</p>	L-3172-1	2.00	8	0,016	1,6240	Adet Pcs	163,00₺
	L-3172-2	2.50		0,02	2,000		204,00₺
	L-3172-3	3.00		0,0357	2,200		244,00₺
<p>Alüminyum Alt Ray / Bottom Rail</p>	L-3171-1	2.00	6	0,011	0,960	Adet Pcs	94,00₺
	L-3171-2	2.50		0,01375	1,200		118,00₺
	L-3171-3	3.00		0,03321	1,200		141,00₺

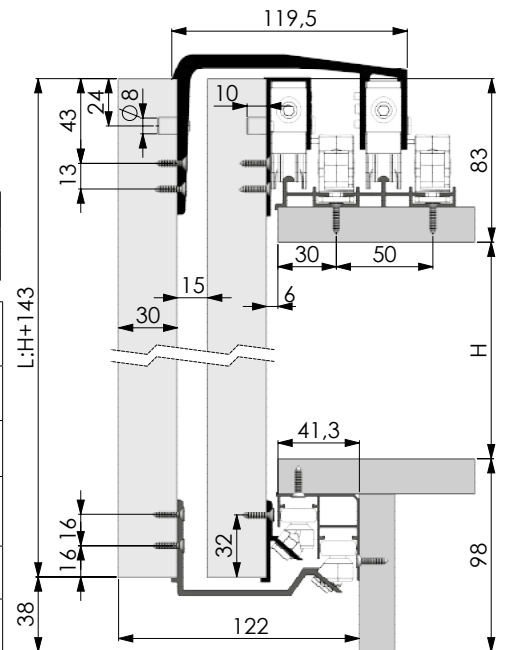

LC54 36-50 mm

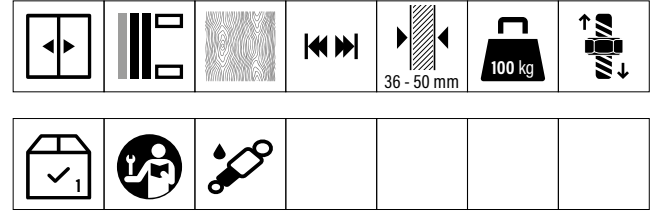

PDF

09

1 Set İeriđi | 1 Set Includes



Code	T (mm)	Box	Volume (m ³)	Weight (kg)	Birim / Unit	Fiyat
L-1243	36-50	4	0,0361	22,66	1Tk - 2 Kapak / 1Set - 2 Doors	475,00₺
L-1246	36-50	4	0,0361	24,2	1Tk - 3 Kapak / 1Set - 3 Doors	668,00₺

Technical Drawing	Code	T (mt)	Bađ Band	Volume (m ³)	Weight (kg)	Unit	Fiyat
<p>Alüminyum Üst Ray / Upper Rail</p>	L-3172-1	2.00	8	0,016	16240	Adet Pcs	163,00₺
	L-3172-2	2.50		0,02	2,000		204,00₺
	L-3172-3	3.00		0,0357	2,200		244,00₺
<p>Alüminyum Alt Ray / Bottom Rail</p>	L-3171-1	2.00	6	0,011	0,960	Adet Pcs	94,00₺
	L-3171-2	2.50		0,01375	1,200		118,00₺
	L-3171-3	3.00		0,03321	1,200		141,00₺

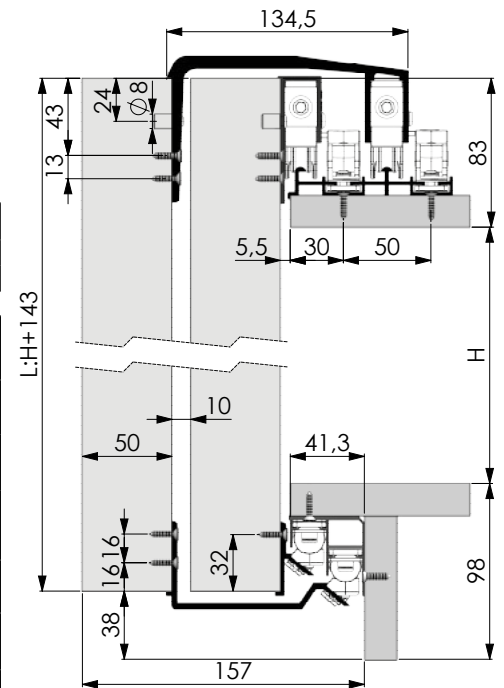



LC55 18-25 mm

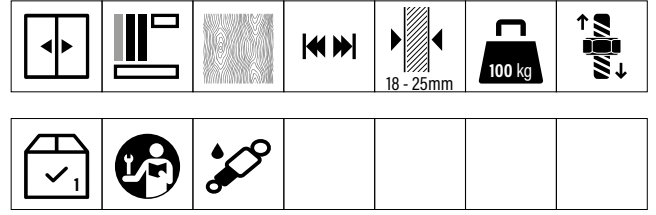

PDF

1 Set İçeriği | 1 Set Includes

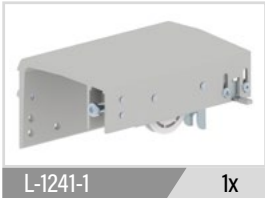

L-1241-1

1x



L-1241-11

1x



L-1241-2

1x



L-1241-21

1x

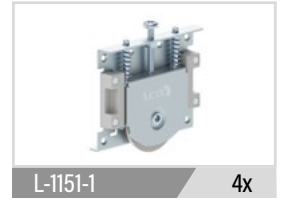

L-1151-1

4x



L-4110

4x

Code	T (mm)	Box	Volume (m ³)	Weight (kg)	Birim / Unit	Fiyat
L-1251	18-25	4	0,0361	15,46	1Tk - 2 Kapak / 1Set - 2 Doors	444,00₺
L-1254	18-25	4	0,0361	17	1Tk - 3 Kapak / 1Set - 3 Doors	638,00₺

Technical Drawing	Code	T (mt)	Bağ Band	Volume (m ³)	Weight (kg)	Unit	Fiyat
<p>Alüminyum Üst Ray / Upper Rail</p>	L-3172-1	2.00	8	0,016	1,6240	Adet Pcs	163,00₺
	L-3172-2	2.50		0,02	2,0300		204,00₺
	L-3172-3	3.00		0,0357	2,200		244,00₺
<p>PVC Alt Ray / Bottom Rail</p>	L-3703	3.00	50	0,0225	0,200	Adet Pcs	11,40₺

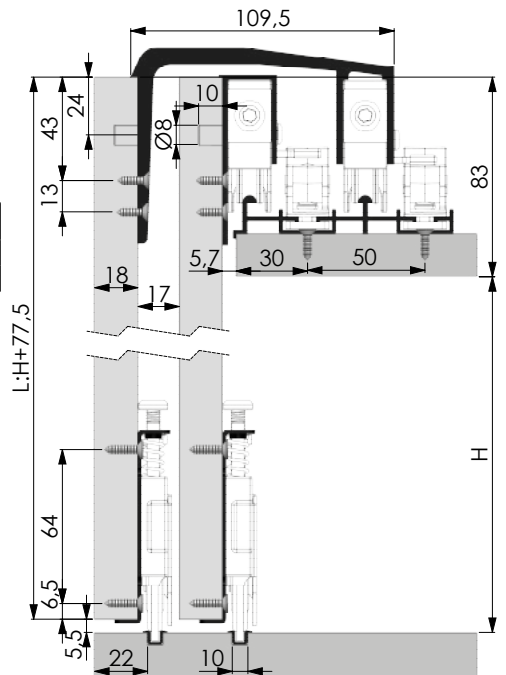

LC55 26-35 mm

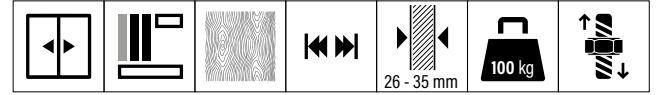

PDF

09

1 Set İeriđi | 1 Set Includes

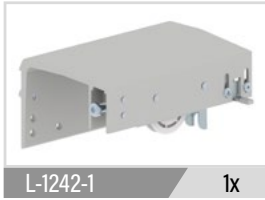

Code	T (mm)	Box	Volume (m ³)	Weight (kg)	Birim / Unit	Fiyat
L-1252	26-35	4	0,0361	17,26	1Tk - 2 Kapak / 1Set - 2 Doors	444,00₺
L-1255	26-35	4	0,0361	18,8	1Tk - 3 Kapak / 1Set - 3 Doors	638,00₺

Technical Drawing	Code	T (mt)	Bađ Band	Volume (m ³)	Weight (kg)	Unit	Fiyat
<p>Alüminyum Üst Ray / Upper Rail</p>	L-3172-1	2.00	8	0,016	1,6240	Adet Pcs	163,00₺
	L-3172-2	2.50		0,02	2,0300		204,00₺
	L-3172-3	3.00		0,0357	2,200		244,00₺
<p>PVC Alt Ray / Bottom Rail</p>	L-3703	3.00	50	0,0225	0,200	Adet Pcs	11,40₺

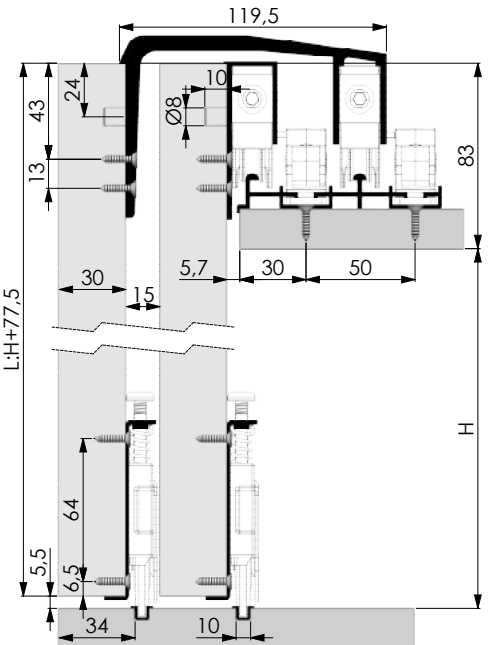



LC55 36-50 mm

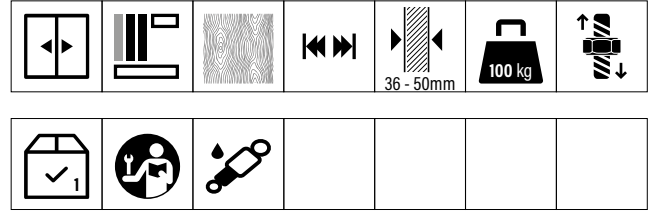

PDF

1 Set İçeriği | 1 Set Includes



Code	T (mm)	Box	Volume (m³)	Weight (kg)	Birim / Unit	Fiyat
L-1253	36-50	4	0,0361	22,66	1Tk - 2 Kapak / 1Set - 2 Doors	512,00₺
L-1256	36-50	4	0,0361	24,2	1Tk - 3 Kapak / 1Set - 3 Doors	638,00₺

Technical Drawing	Code	T (mm)	Bağ Band	Volume (m³)	Weight (kg)	Unit	Fiyat
<p>Alüminyum Üst Ray / Upper Rail</p>	L-3172-1	2.00	8	0,016	1,6240	Adet Pcs	163,00₺
	L-3172-2	2.50		0,02	2,0300		204,00₺
	L-3172-3	3.00		0,0357	2,200		244,00₺
<p>PVC Alt Ray / Bottom Rail</p>	L-3703	3.00	50	0,0225	0,200	Adet Pcs	11,40₺

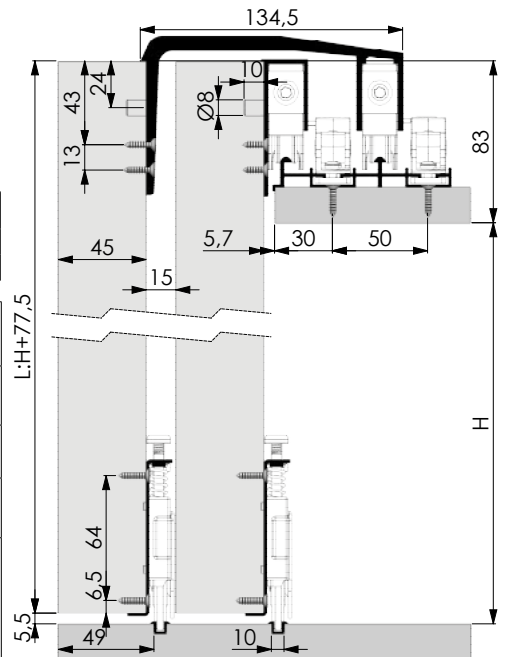

LC60

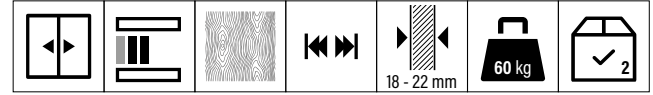

PDF

09

1 Set İeriđi | 1 Set Includes

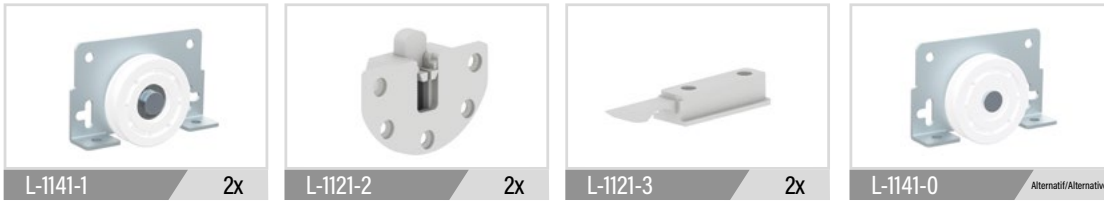

Code	T (mm)	Box	Volume (m ³)	Weight (kg)	Birim / Unit	Fiyat
L-1141	18-22	72	0,027	176	1Tk - 1 Kapak / 1Set - 1 Doors	20,40₺

Technical Drawing	Code	T (mm)	Bađ Band	Volume (m ³)	Weight (kg)	Unit	Fiyat
<p>PVC Üst Ray / Upper Rail</p>	L-3703	3.00	50	0,0225	0,200	Adet Pcs	11,40₺
<p>PVC Alt Ray / Bottom Rail</p>	L-3701	3.00	50	0,03375	0,165	Adet Pcs	9,50₺
<p>Alüminyum Alt Ray / Bottom Rail</p>	L-3106	3.00	50	0,022	0,300	Adet Pcs	35,20₺

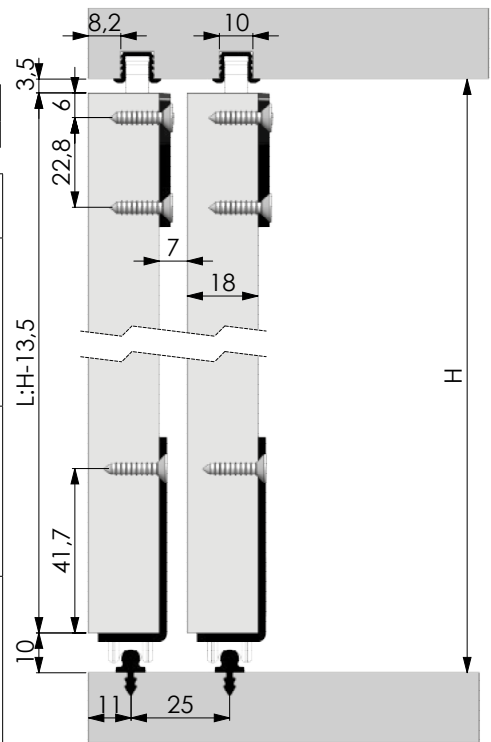



LC75 AY

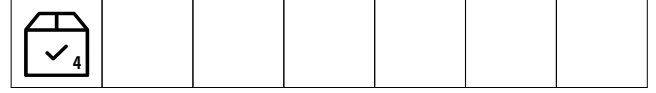
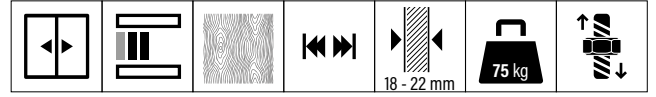

PDF

1 Set İçeriği | 1 Set Includes

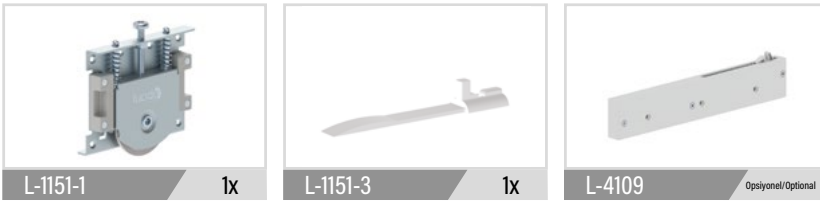

L-1151-1 1x L-1151-3 1x L-4109 Opsiyonel/Optional

Code	T (mm)	Box	Volume (m ³)	Weight (kg)	Birim / Unit	Fiyat
L-1151	18-22	108	0,025	25,9	1 Adet / 1 Piece	15,60₺

Technical Drawing	Code	T (mt)	Bağ Band	Volume (m ³)	Weight (kg)	Unit	Fiyat
<p>Alüminyum Alt-Üst Ray / Bottom-Upper Rail</p>	L-3110-1	2.00	20	0,024	0,500	Adet Pcs	42,00₺
	L-3110-2	2.50		0,03	0,500		53,00₺
	L-3110-3	3.00		0,036	0,700		63,00₺
<p>Alüminyum Alt-Üst Ray / Bottom-Upper Rail</p>	L-3111-1	2.00	20	0,0012	0,4520	Adet Pcs	48,00₺
	L-3111-2	2.50		0,0015	0,5650		61,00₺
	L-3111-3	3.00		0,054	0,600		72,00₺
<p>PVC Alt Ray / Bottom Rail</p>	L-3703	3.00	50	0,0225	0,200	Adet Pcs	11,40₺

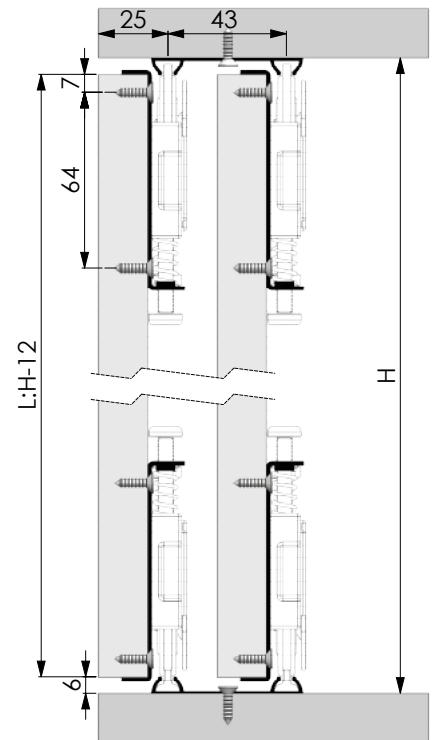

LC75 AY-UK

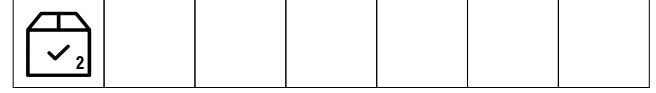
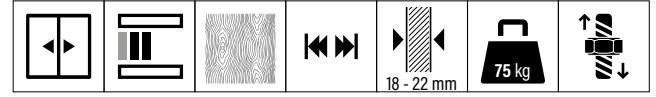

PDF

09

1 Set İçeriği | 1 Set Includes



Code	T (mm)	Box	Volume (m ³)	Weight (kg)	Birim / Unit	Fiyat
L-1152	18-22	42	0,035	28,56	1 Tk - 1 Kapak / 1 Set - 1 Doors	39,00₺

Technical Drawing	Code	T (mm)	Bağ Band	Volume (m ³)	Weight (kg)	Unit	Fiyat
<p>Alüminyum Alt-Üst Ray / Bottom-Upper Rail</p>	L-3142-1	2.00	20	0,0096	0,4160	Adet Pcs	41,10₺
	L-3142-2	2.50		0,012	0,5200		51,00₺
	L-3142-3	3.00		0,0144	0,6240		62,00₺
<p>Alüminyum Üst Ray / Upper Rail</p>	L-3123-1	2.00	10	0,015	0,9140	Adet Pcs	90,00₺
	L-3123-2	2.50		0,019	1,1425		112,00₺
	L-3123-3	3.00		0,023	1,3710		135,00₺
<p>Alüminyum Tekli Alt-Üst Ray / Bottom-Upper Rail</p>	L-3124	3.00	20	0,015	0,6240	Adet Pcs	62,00₺
	L-3124-2	2.50		0,0125	0,520		51,00₺
<p>PVC Alt Ray / Bottom Rail</p>	L-3703	3.00	50	0,0225	0,200	Adet Pcs	11,40₺

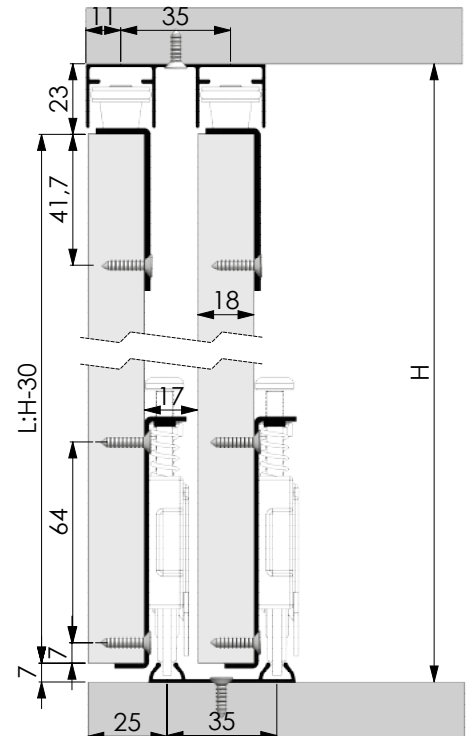



LC75 AY-LUK

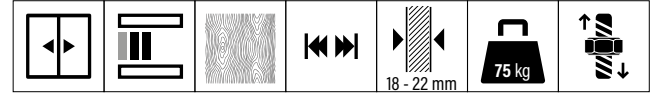

PDF

1 Set İçeriği | 1 Set Includes



Code	T (mm)	Box	Volume (m ³)	Weight (kg)	Birim / Unit	Fiyat
L-1154	18-22	42	0,035	23,5	1 Tk - 1 Kapak / 1 Set - 1 Doors	39,00₺

Technical Drawing	Code	T (mt)	Bağ Band	Volume (m ³)	Weight (kg)	Unit	Fiyat
<p>Alüminyum Alt-Üst Ray / Bottom-Upper Rail</p>	L-3142-1	2.00	20	0,0096	0,4160	Adet Pcs	41,10₺
	L-3142-2	2.50		0,012	0,5200		51,00₺
	L-3142-3	3.00		0,0144	0,6240		62,00₺
<p>Alüminyum Üst Ray / Upper Rail</p>	L-3123-1	2.00	10	0,015	0,9140	Adet Pcs	90,00₺
	L-3123-2	2.50		0,019	1,1425		112,00₺
	L-3123-3	3.00		0,023	1,3710		135,00₺
<p>Alüminyum Tekli Alt-Üst Ray / Bottom-Upper Rail</p>	L-3124	3.00	20	0,015	0,6240	Adet Pcs	62,00₺
	L-3124-2	2.50		0,0125	0,520		51,00₺
<p>PVC Alt Ray / Bottom Rail</p>	L-3703	3.00	50	0,0225	0,200	Adet Pcs	11,40₺

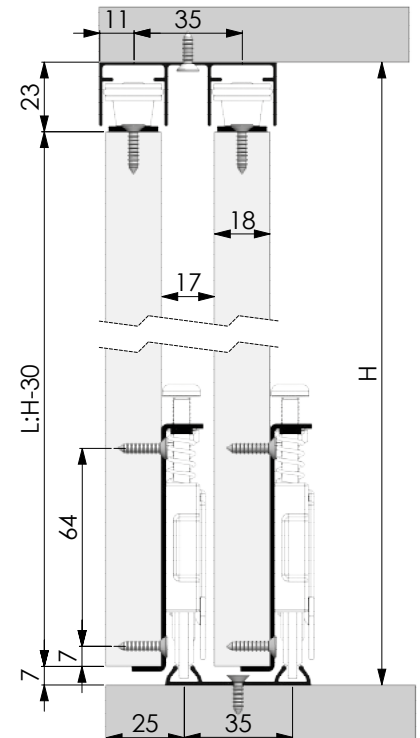

LC75 AY UK K

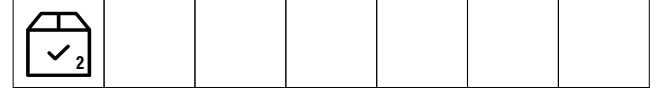
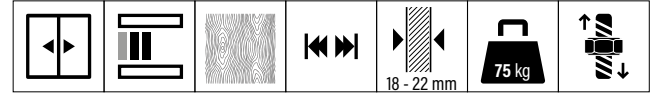

PDF

09

1 Set İçeriği | 1 Set Includes

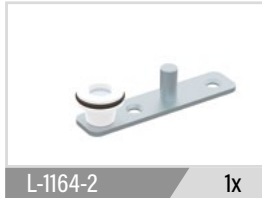
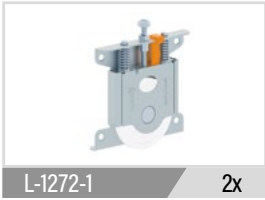

Code	T (mm)	Box	Volume (m ³)	Weight (kg)	Birim / Unit	Fiyat
L-1153	18-22	54	0,025	20,8	1Tk - 1 Kapak / 1 Set - 1 Doors	30,00₺

Technical Drawing	Code	T (mm)	Bağ Band	Volume (m ³)	Weight (kg)	Unit	Fiyat
<p>Alüminyum Alt-Üst Ray / Bottom-Upper Rail</p>	L-3142-1	2.00	20	0,0096	0,4160	Adet Pcs	41,10₺
	L-3142-2	2.50		0,012	0,5200		51,00₺
	L-3142-3	3.00		0,0144	0,6240		62,00₺
<p>Alüminyum Üst Ray / Upper Rail</p>	L-3123-1	2.00	10	0,015	0,9140	Adet Pcs	90,00₺
	L-3123-2	2.50		0,019	1,1425		112,00₺
	L-3123-3	3.00		0,023	1,3710		135,00₺
<p>Alüminyum Tekli Alt-Üst Ray / Bottom-Upper Rail</p>	L-3124	3.00	20	0,015	0,6240	Adet Pcs	62,00₺
	L-3124-2	2.50		0,0125	0,520		51,00₺
<p>PVC Alt Ray / Bottom Rail</p>	L-3703	3.00	50	0,0225	0,200	Adet Pcs	11,40₺

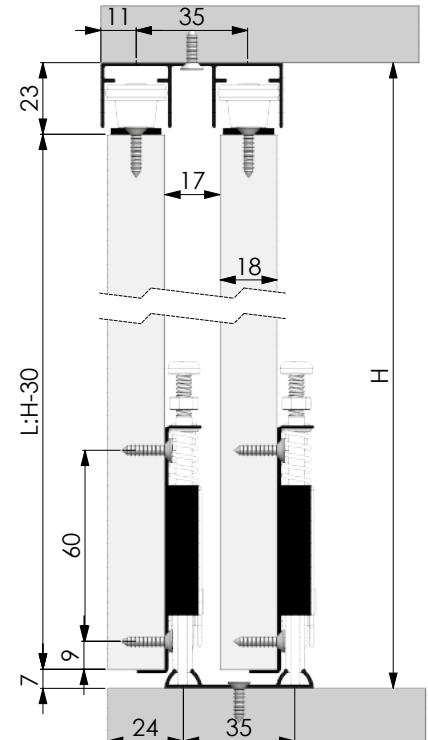



LC75 MIX ECO

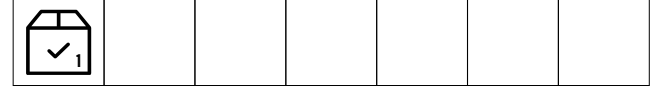
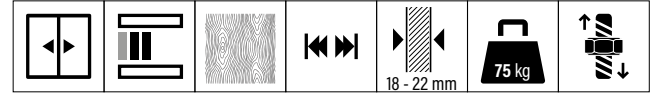

PDF

1 Set İçeriği | 1 Set Includes

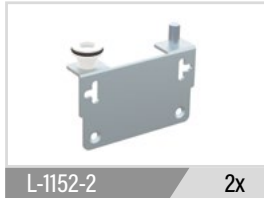

Code	T (mm)	Box	Volume (m ³)	Weight (kg)	Birim / Unit	Fiyat
L-1159	18-22	28	0,035	28,35	1 Tk - 2 Kapak / 1 Set - 2 Doors	62,00₺

Technical Drawing	Code	T (mt)	Bağ Band	Volume (m ³)	Weight (kg)	Unit	Fiyat
<p>Alüminyum Alt-Üst Ray / Bottom-Upper Rail</p>	L-3142-1	2.00	20	0,0096	0,4160	Adet Pcs	41,10₺
	L-3142-2	2.50		0,012	0,5200		51,00₺
	L-3142-3	3.00		0,0144	0,6240		62,00₺
<p>Alüminyum Üst Ray / Upper Rail</p>	L-3123-1	2.00	10	0,015	0,9140	Adet Pcs	90,00₺
	L-3123-2	2.50		0,019	1,1425		112,00₺
	L-3123-3	3.00		0,023	1,3710		135,00₺
<p>Alüminyum Tekli Alt-Üst Ray / Bottom-Upper Rail</p>	L-3124	3.00	20	0,015	0,6240	Adet Pcs	62,00₺
	L-3124-2	2.50		0,0125	0,520		51,00₺
<p>PVC Alt Ray / Bottom Rail</p>	L-3703	3.00	50	0,0225	0,200	Adet Pcs	11,40₺

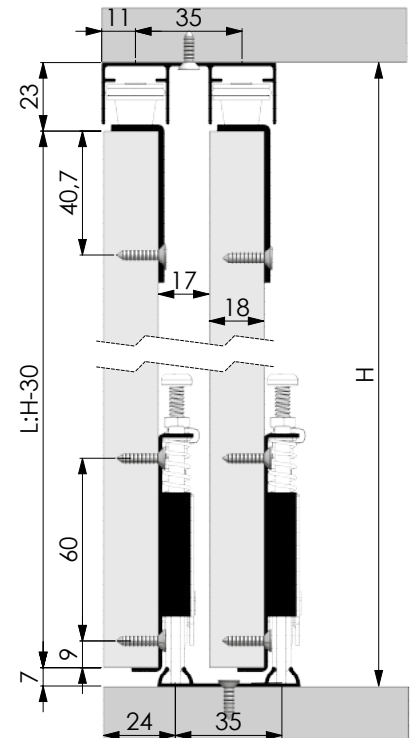

LC81 AY

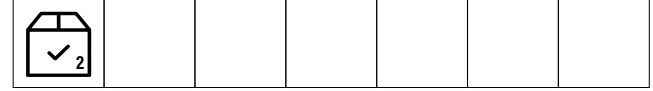
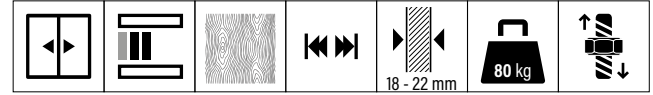

PDF

09

1 Set İçeriği | 1 Set Includes

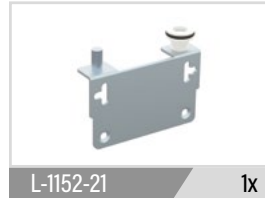
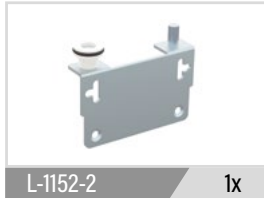

Code	T (mm)	Box	Volume (m³)	Weight (kg)	Birim / Unit	Fiyat
L-1158	18-22	56	0,035	18,1	1Tk-1 Kapak / 1 Set-1 Doors	36,20₺

Technical Drawing	Code	T (mt)	Bağ Band	Volume (m³)	Weight (kg)	Unit	Fiyat
<p>Alüminyum Üst Ray / Upper Rail</p>	L-3123-1	2.00	10	0,015	0,9140	Adet Pcs	90,00₺
	L-3123-2	2.50		0,019	1,1425		112,00₺
	L-3123-3	3.00		0,023	1,3710		135,00₺
<p>Alüminyum Alt Ray / Bottom Rail</p>	L-3125-1	2.00	20	0,013	0,5260	Adet Pcs	48,00₺
	L-3125-2	2.50		0,01625	0,6575		60,00₺
	L-3125-3	3.00		0,0195	0,7890		72,00₺

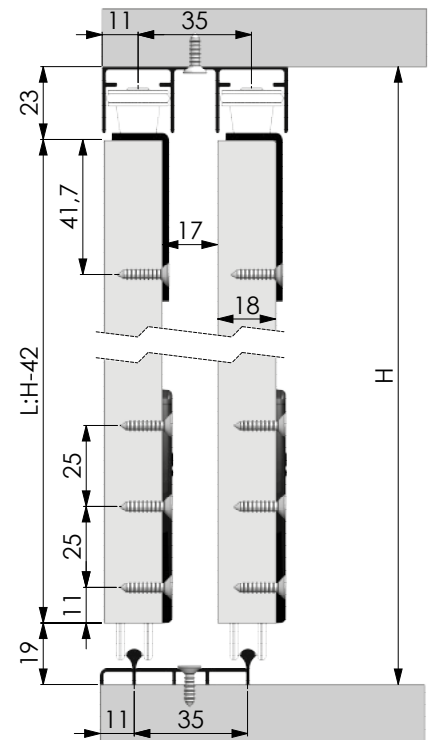



LC71 AY

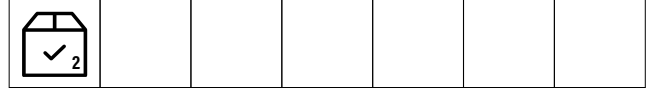
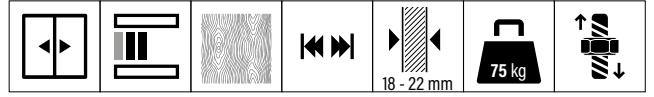

PDF

1 Set İçeriği | 1 Set Includes



L-1157-1

2x

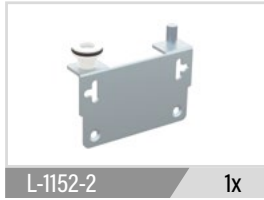

L-1152-2

1x

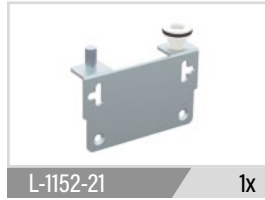

L-1152-21

1x

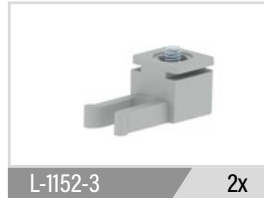

L-1152-3

2x



L-2101-9

1x



L-4109

Opsiyonel/Optional

Code	T (mm)	Box	Volume (m³)	Weight (kg)	Birim / Unit	Fiyat
L-1157	18-22	56	0,035	25,52	1Tk-1 Kapak / 1 Set- 1 Doors	38,10₺

Technical Drawing	Code	T (mt)	Bağ Band	Volume (m³)	Weight (kg)	Unit	Fiyat
<p>Alüminyum Üst Ray / Upper Rail</p>	L-3124	3.00	20	0,015	0,6240	Adet Pcs	62,00₺
	L-3124-2	2.50		0,0125	0,520		51,00₺
<p>Alüminyum Alt Ray / Bottom Rail</p>	L-3110-1	2.00	20	0,024	0,500	Adet Pcs	42,00₺
	L-3110-2	2.50		0,03	0,600		53,00₺
	L-3110-3	3.00		0,038	0,700		63,00₺

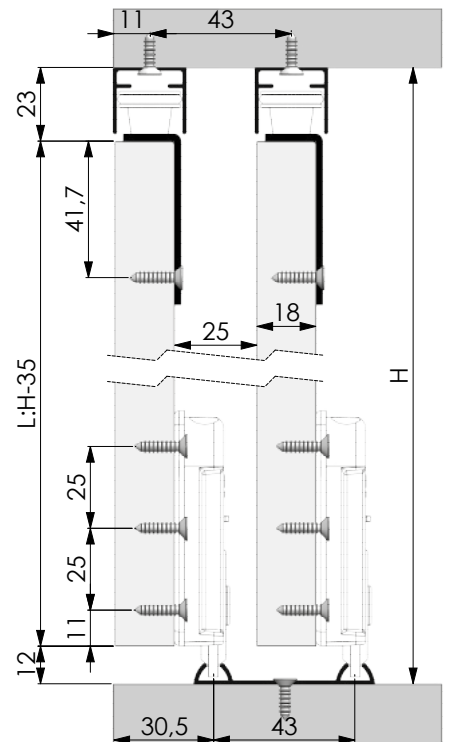

LC75 AY-SC

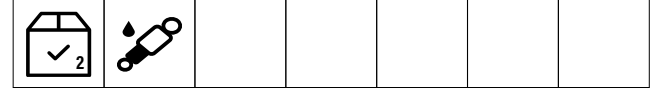
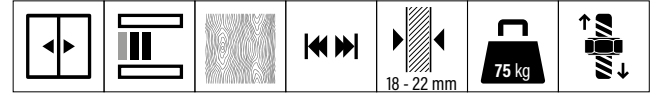

PDF

09

1 Set İçeriği | 1 Set Includes

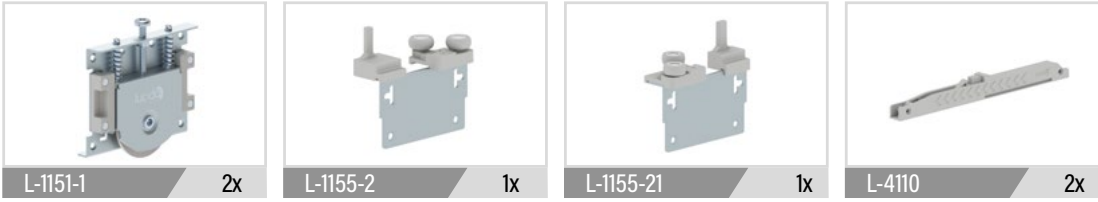

Code	T (mm)	Box	Volume (m³)	Weight (kg)	Birim / Unit	Fiyat
L-1155	18-22	24	0,035	22,3	1Tk - 1 Kapak / 1Set - 1 Doors	93,00₺

Technical Drawing	Code	T (mt)	Bağ Band	Volume (m³)	Weight (kg)	Unit	Fiyat
<p>Alüminyum Üst Ray / Upper Rail</p>	L-3145-1	2.00	6	0,0208	1,4860	Adet Pcs	137,00₺
	L-3145-2	2.50		0,026	1,8575		171,00₺
	L-3145-3	3.00		0,0432	2,235		205,00₺
<p>Alüminyum Alt Ray / Bottom Rail</p>	L-3143-1	2.00	20	0,011	0,5700	Adet Pcs	57,00₺
	L-3143-2	2.50		0,03	0,7125		70,00₺
	L-3143-3	3.00		0,036	0,800		84,00₺
<p>Alüminyum Alt Ray Kapak Profili / Aluminium Bottom Rail Cover Profile</p>	L-3144-1	2.00	40	0,0042	0,1180	Adet Pcs	18,00₺
	L-3144-2	2.50		0,00525	0,1475		22,60₺
	L-3144-3	3.00		0,0063	0,1770		27,00₺

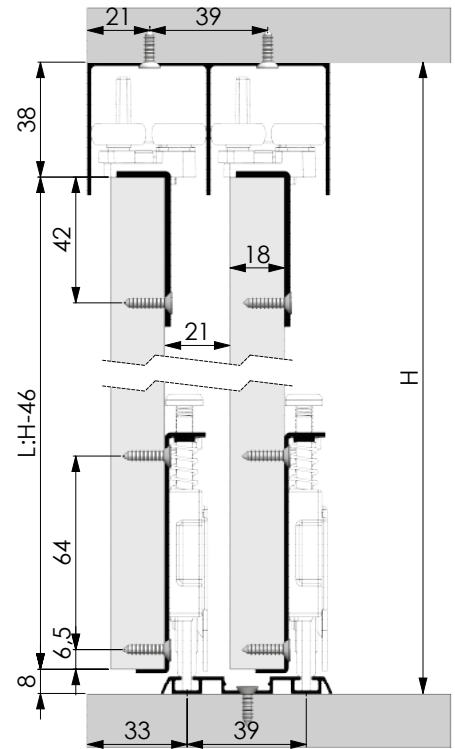



LC80 BETA RULMANSIZ / WITHOUT BALL BEARING

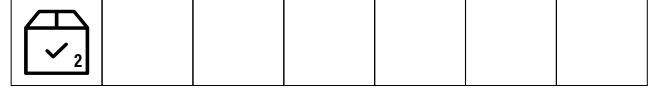
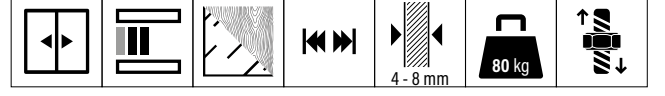

PDF

1 Set İçeriği | 1 Set Includes

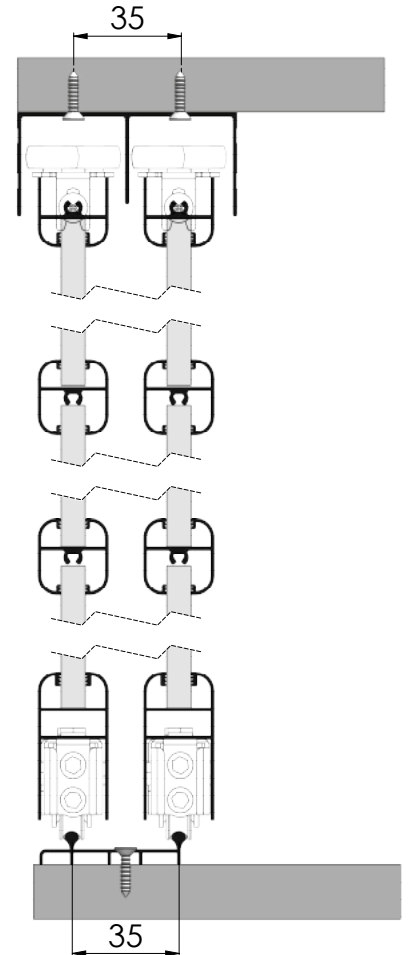
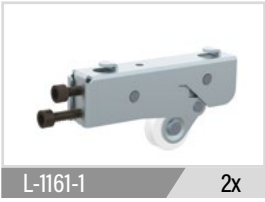

Code	T (mm)	Box	Volume (m ³)	Weight (kg)	Birim / Unit	Fiyat
L-1161	4-8	72	0,027	22,3	1Tk-1 Kapak / 1 Set - 1 Doors	32,00₺

LC80 GAMA RULMANSIZ / WITHOUT BALL BEARING

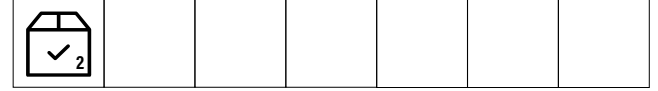
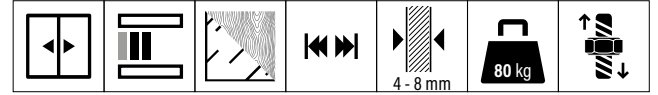

PDF

09

1 Set İçeriği | 1 Set Includes

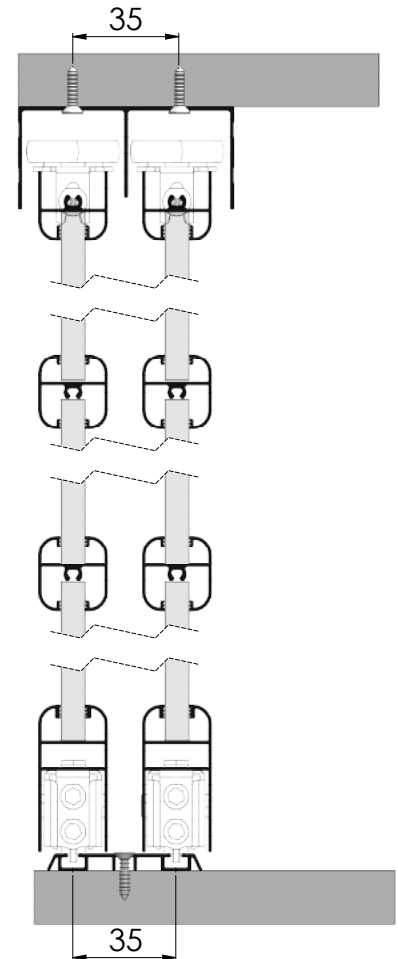
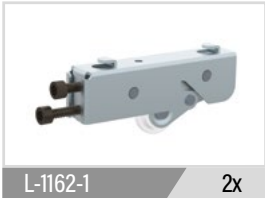

Code	T (mm)	Box	Volume (m³)	Weight (kg)	Birim / Unit	Fiyat
L-1162	4-8	72	0,027	22,3	1Tk-1 Kapak / 1 Set - 1 Doors	32,00₺



LC80 ALFA RULMANSIZ / WITHOUT BALL BEARING

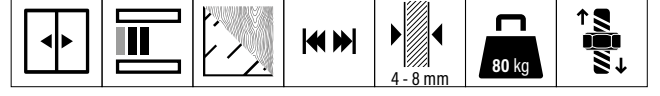

PDF

1 Set İeriđi | 1 Set Includes

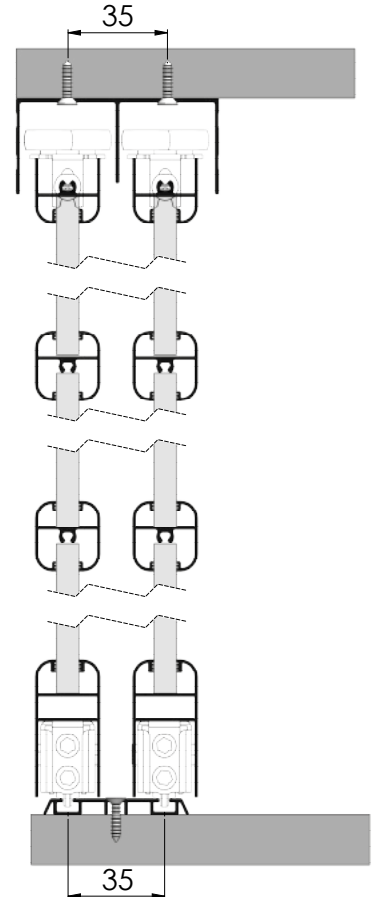

Code	T (mm)	Box	Volume (m ³)	Weight (kg)	Birim / Unit	Fiyat
L-1163	4-8	72	0,027	22,3	1Tk-1 Kapak / 1 Set - 1 Doors	32,00₺

LC80 BETA RULMANLI / WITH BALL BEARING

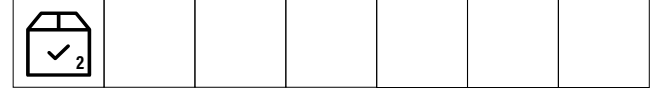
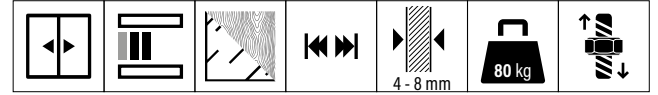

PDF

09

1 Set İçeriği | 1 Set Includes

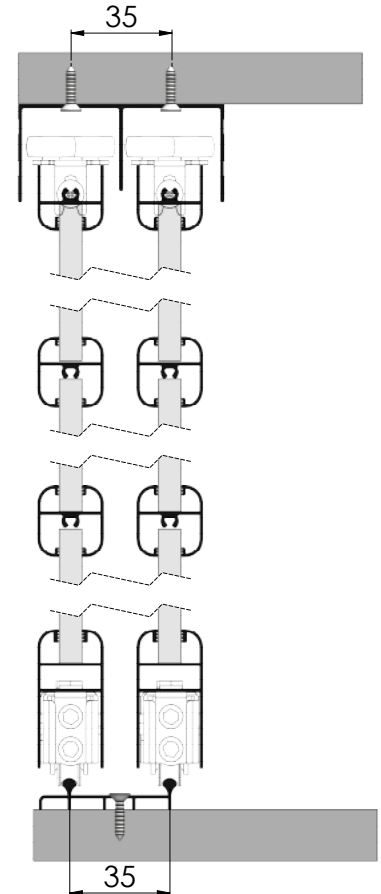

Code	T (mm)	Box	Volume (m³)	Weight (kg)	Birim / Unit	Fiyat
L-1165	4-8	72	0,027	22,3	1Tk-1 Kapak / 1 Set - 1 Doors	41,00₺



LC80 GAMA RULMANLI / WITH BALL BEARING

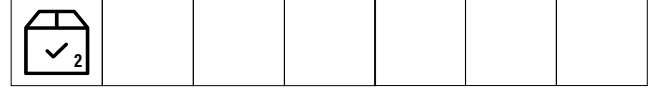
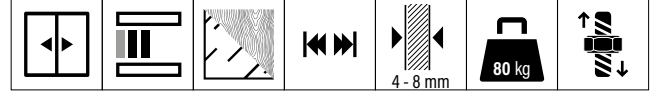

PDF

1 Set İçeriği | 1 Set Includes

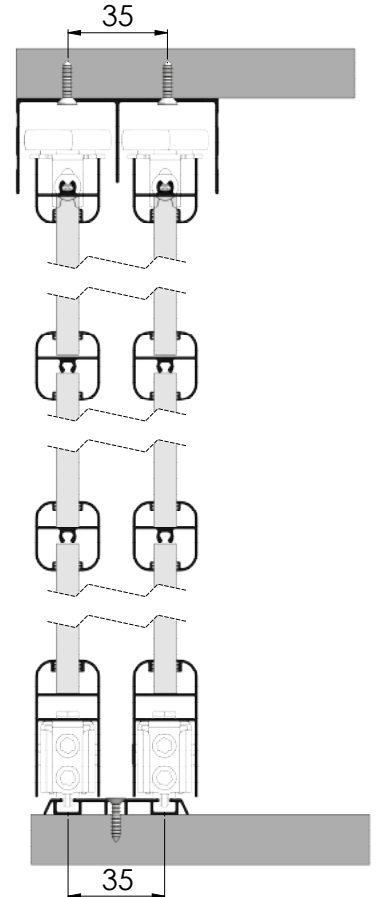
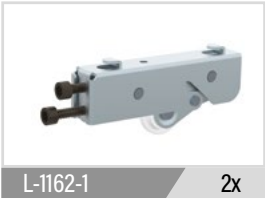

Code	T (mm)	Box	Volume (m³)	Weight (kg)	Birim / Unit	Fiyat
L-1166	4-8	72	0,027	22,3	1Tk-1 Kapak / 1 Set - 1 Doors	41,00₺

LC80 ALFA RULMANLI / WITH BALL BEARING

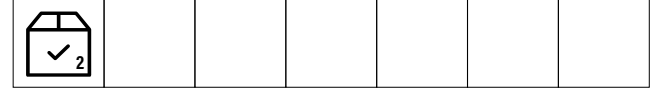
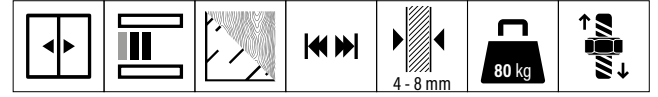

PDF

09

1 Set İeriđi | 1 Set Includes

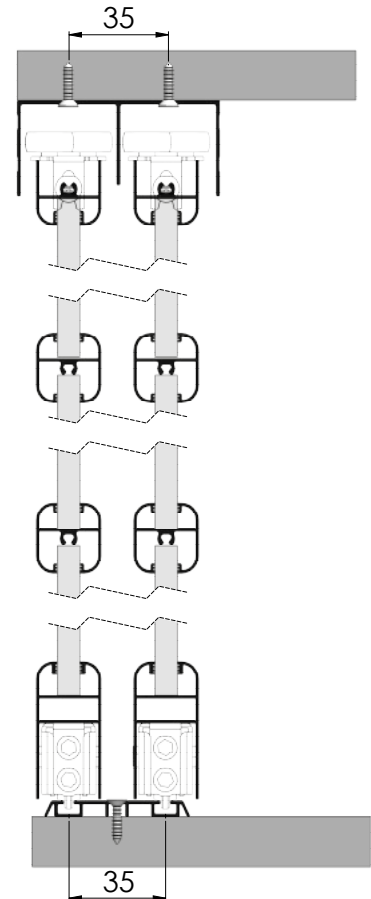
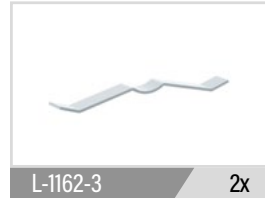

Code	T (mm)	Box	Volume (m³)	Weight (kg)	Birim / Unit	Fiyat
L-1167	4-8	72	0,027	22,3	1Tk-1 Kapak / 1 Set - 1 Doors	41,00₺



LC80 VEGA

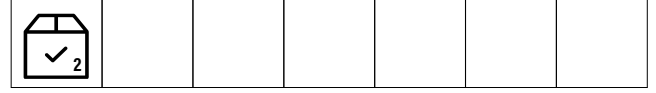
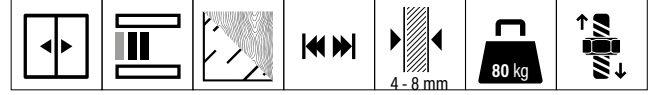

PDF

1 Set İçeriği | 1 Set Includes

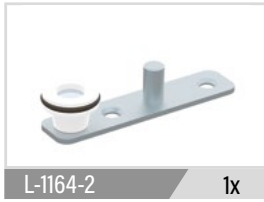

Code	T (mm)	Box	Volume (m³)	Weight (kg)	Birim / Unit	Fiyat
L-1164	4-8	72	0,027	14	1 Tk - 1 Kapak / 1 Set - 1 Doors	25,20₺

Technical Drawing	Code	T (mm)	Bağ Band	Volume (m³)	Weight (kg)	Unit	Fiyat
<p>Alüminyum Alt-Üst Ray / Bottom-Upper Rail</p>	L-3142-1	2.00	20	0,0096	0,4160	Adet Pcs	41,10₺
	L-3142-2	2.50		0,012	0,5200		51,00₺
	L-3142-3	3.00		0,0144	0,6240		62,00₺
<p>Alüminyum Üst Ray / Upper Rail</p>	L-3123-1	2.00	10	0,015	0,9140	Adet Pcs	90,00₺
	L-3123-2	2.50		0,019	1,1425		112,00₺
	L-3123-3	3.00		0,023	1,3710		135,00₺
<p>Alüminyum Tekli Alt-Üst Ray / Bottom-Upper Rail</p>	L-3124	3.00	20	0,015	0,6240	Adet Pcs	62,00₺
	L-3124-2	2.50		0,0125	0,520		51,00₺

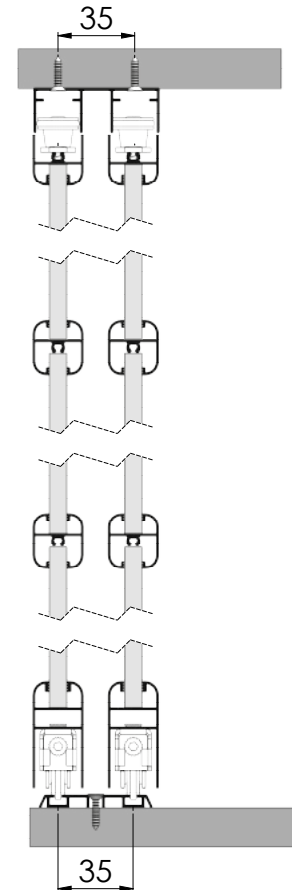

LC85

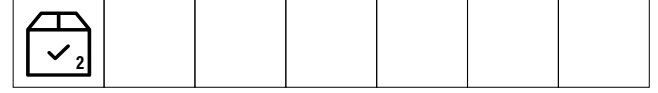
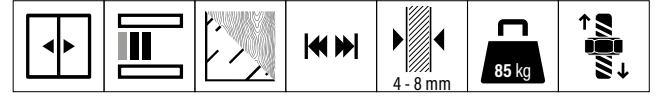

PDF

09

1 Set İçeriği | 1 Set Includes

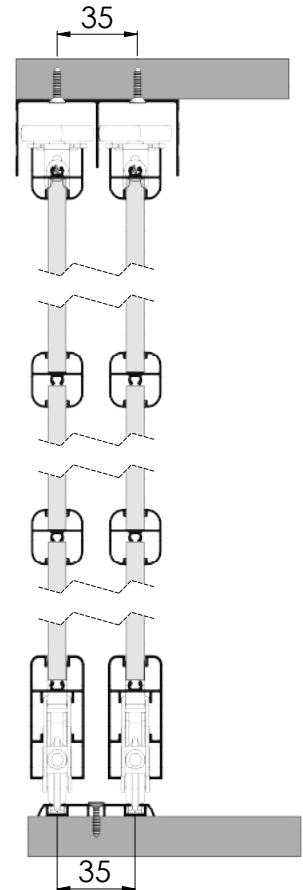
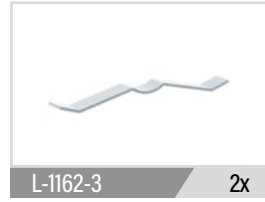

Code	T (mm)	Box	Volume (m³)	Weight (kg)	Birim / Unit	Fiyat
L-1171	4-8	72	0,027	20	1Tk-1 Kapak / 1 Set - 1 Doors	59,00₺



LC87

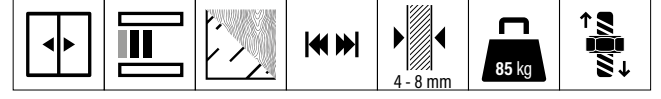

PDF

1 Set İçeriği | 1 Set Includes

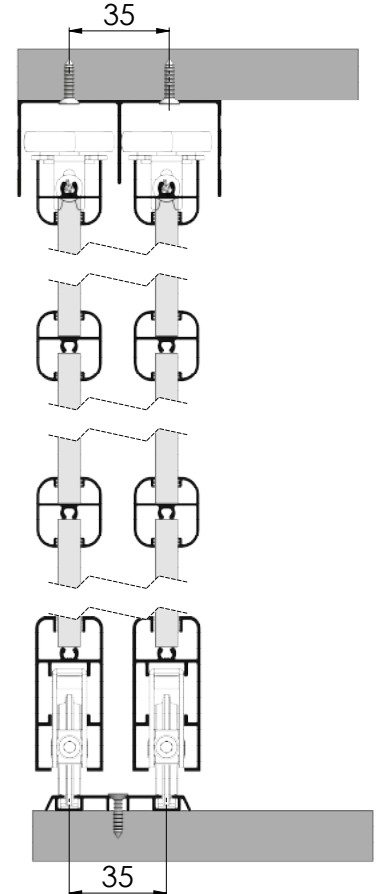

Code	T (mm)	Box	Volume (m ³)	Weight (kg)	Birim / Unit	Fiyat
L-1173	4-8	72	0,027	16	1Tk-1 Kapak / 1 Set-1 Doors	44,00₺

LC70 AY

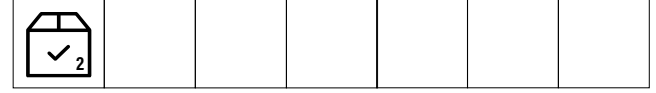
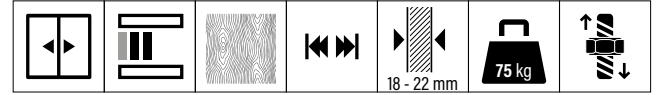

PDF

09

1 Set İçeriği | 1 Set Includes



Code	T (mm)	Box	Volume (m³)	Weight (kg)	Birim / Unit	Fiyat
L-1181	18-22	56	0,035	28,45	1Tk - 1 Kapak / 1 Set - 1 Doors	31,20₺

Technical Drawing	Code	T (mm)	Bağ Band	Volume (m³)	Weight (kg)	Unit	Fiyat
<p>Alüminyum Üst Ray / Upper Rail</p>	L-3123-1	2.00	10	0,015	0,9140	Adet Pcs	90,00₺
	L-3123-2	2.50		0,019	1,1425		112,00₺
	L-3123-3	3.00		0,023	1,3710		135,00₺
<p>Alüminyum Tekli Alt-Üst Ray / Bottom-Upper Rail</p>	L-3124	3.00	20	0,015	0,524	Adet Pcs	62,00₺
	L-3124-2	2.50		0,0125	0,520		51,00₺
<p>Alüminyum Alt-Üst Ray / Bottom-Upper Rail</p>	L-3142-1	2.00	20	0,0096	0,4160	Adet Pcs	41,10₺
	L-3142-2	2.50		0,012	0,5200		51,00₺
	L-3142-3	3.00		0,0144	0,6240		62,00₺
<p>PVC Alt Ray / Bottom Rail</p>	L-3703	3.00	50	0,0225	0,200	Adet Pcs	11,40₺

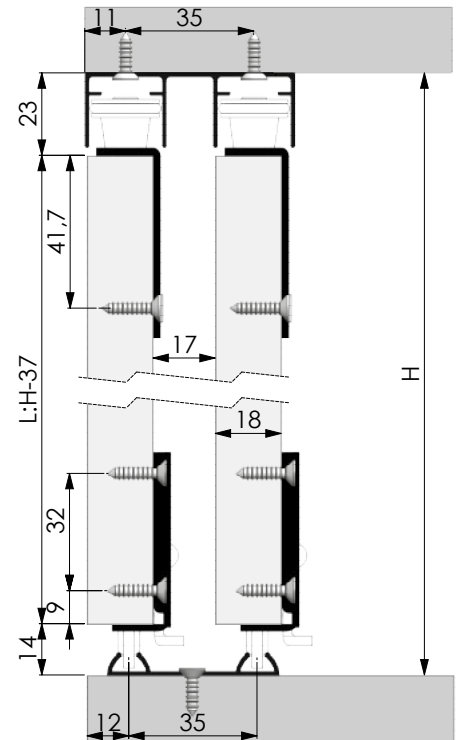



LC80 AY

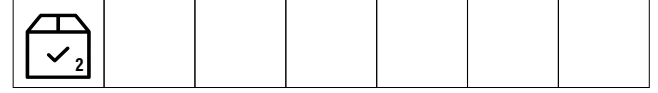
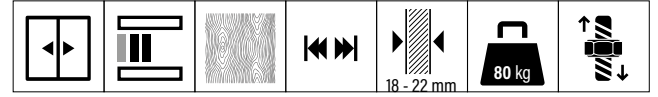

PDF

1 Set İçeriği | 1 Set Includes

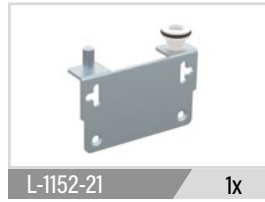
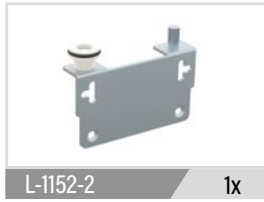
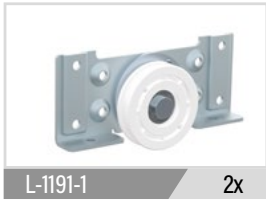

Code	T (mm)	Box	Volume (m³)	Weight (kg)	Birim / Unit	Fiyat
L-1191	18-22	56	0,035	29,5	1 Tk - 1 Kapak / 1 Set - 1 Doors	29,10₺

Technical Drawing	Code	T (mm)	Bağ Band	Volume (m³)	Weight (kg)	Unit	Fiyat
<p>Alüminyum Üst Ray / Upper Rail</p>	L-3123-1	2.00	10	0,015	0,9140	Adet Pcs	90,00₺
	L-3123-2	2.50		0,019	1,1425		112,00₺
	L-3123-3	3.00		0,023	1,3710		135,00₺
<p>Alüminyum Tekli Alt-Üst Ray / Bottom-Upper Rail</p>	L-3124	3.00	10	0,015	0,6240	Adet Pcs	62,00₺
	L-3124-2	2.50		0,0125	0,520		51,00₺
<p>Alüminyum Alt Ray / Bottom Rail</p>	L-3125-1	2.00	20	0,013	0,5260	Adet Pcs	48,00₺
	L-3125-2	2.50		0,01625	0,6575		60,00₺
	L-3125-3	3.00		0,0195	0,7890		72,00₺
<p>Alüminyum Alt-Üst Ray / Bottom-Upper Rail</p>	L-3106	3.00	20	0,03375	0,300	Adet Pcs	35,20₺

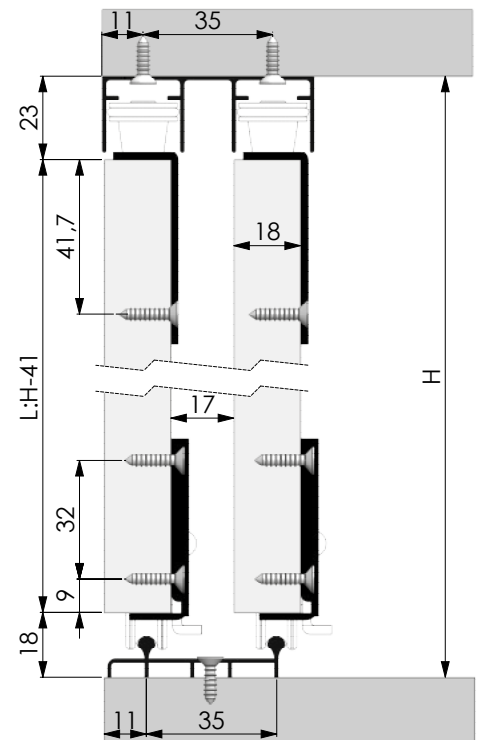

LC80 AYS

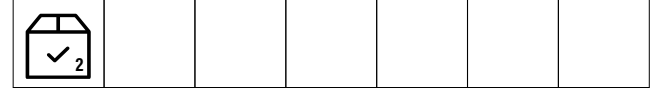
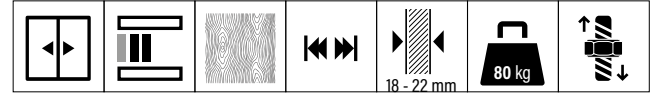

PDF

09

1 Set İçeriği | 1 Set Includes

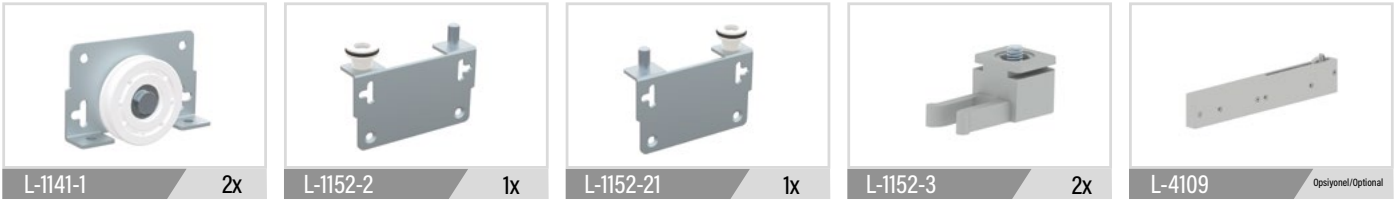

Code	T (mm)	Box	Volume (m³)	Weight (kg)	Birim / Unit	Fiyat
L-1192	18-22	56	0,035	24	1Tk -1 Kapak / 1Set -1 Doors	23,10₺

Technical Drawing	Code	T (mt)	Bağ Band	Volume (m³)	Weight (kg)	Unit	Fiyat
<p>Alüminyum Üst Ray / Upper Rail</p>	L-3123-1	2.00	10	0,015	0,9140	Adet Pcs	90,00₺
	L-3123-2	2.50		0,019	1,1425		112,00₺
	L-3123-3	3.00		0,023	1,3710		135,00₺
<p>Alüminyum Tekli Alt-Üst Ray / Bottom-Upper Rail</p>	L-3124	3.00	10	0,015	0,6240	Adet Pcs	62,00₺
	L-3124-2	2.50		0,0125	0,520		51,00₺
<p>Alüminyum Alt Ray / Bottom Rail</p>	L-3125-1	2.00	20	0,013	0,5260	Adet Pcs	48,00₺
	L-3125-2	2.50		0,01625	0,6575		60,00₺
	L-3125-3	3.00		0,0195	0,7890		72,00₺
<p>Alüminyum Alt-Üst Ray / Bottom-Upper Rail</p>	L-3106	3.00	20	0,03375	0,300	Adet Pcs	35,20₺

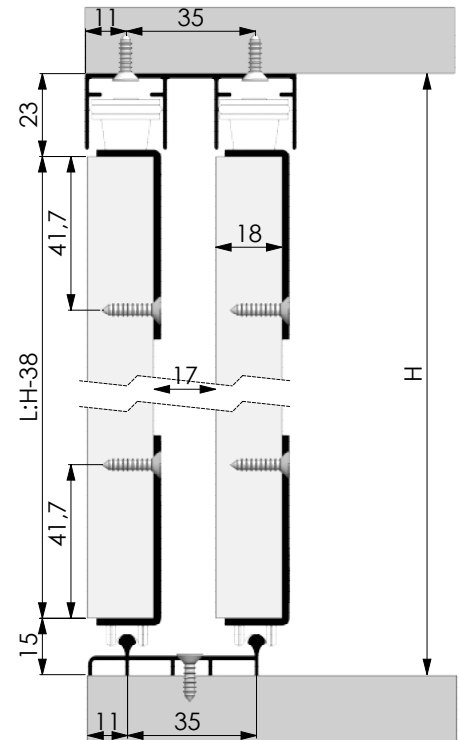



LC130 2P

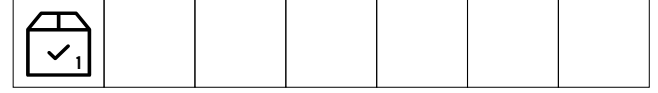
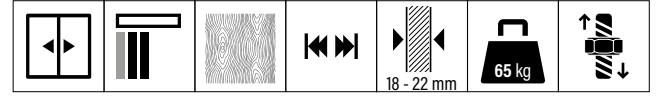

PDF

1 Set İçeriği | 1 Set Includes

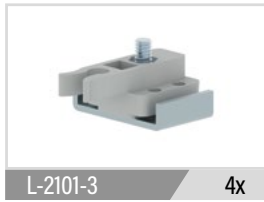

Code	T (mm)	Box	Volume (m³)	Weight (kg)	Birim / Unit	Fiyat
L-1201	18-22	40	0,035	23,32	1Tk - 2 Kapak / 1Set - 2 Doors	87,00₺
L-1202	18-22	40	0,035	34,8	1Tk - 3 Kapak / 1Set - 3 Doors	123,00₺

Technical Drawing	Code	T (mt)	Bağ Band	Volume (m³)	Weight (kg)	Unit	Fiyat
<p>Alüminyum Üst Ray / Upper Rail</p>	L-3127-1	2.00	10	0,0245	0,900	Adet Pcs	105,00₺
	L-3127-3	3.00		0,0288	1,602		157,00₺
<p>PVC Alt Ray / Bottom Rail</p>	L-3703	3.00	50	0,0225	0,200	Adet Pcs	11,40₺

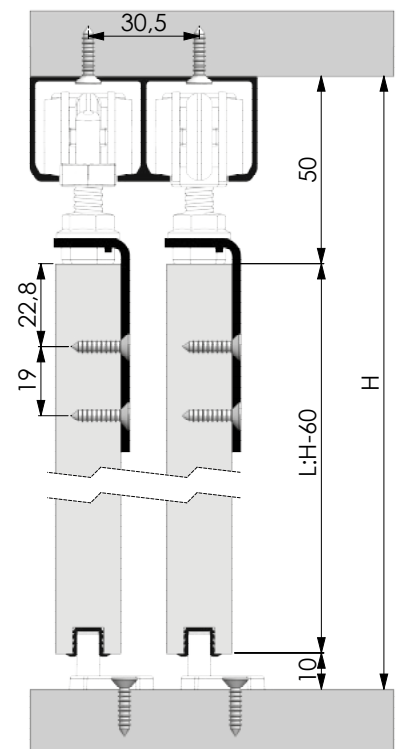

LC57

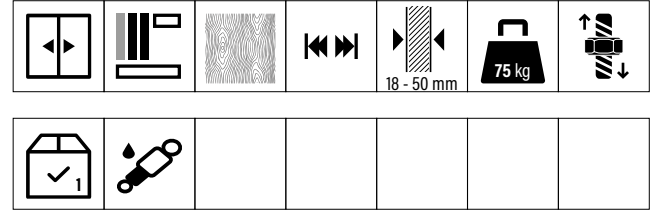

PDF

09

1 Set İçeriği | 1 Set Includes

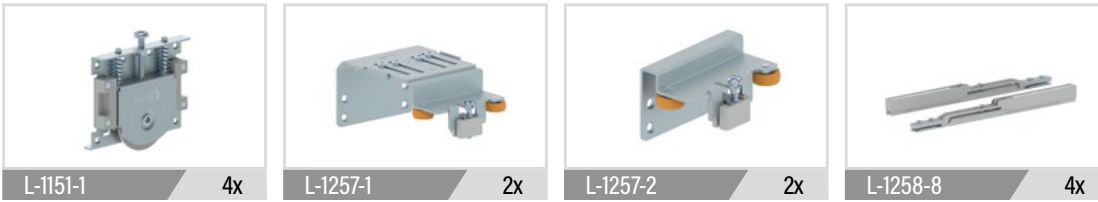

Code	T (mm)	Box	Volume (m ³)	Weight (kg)	Birim / Unit	Fiyat
L-1257	18-50	8	0,035	178	1 Tk - 2 Kapak / 1 Set - 2 Doors	227,00₺
L-1262	18-50	8	0,035	23,4	1Tk - 3 Kapak / 1 Set - 3 Doors	296,00₺

Technical Drawing	Code	T (mt)	Bağ Band	Volume (m ³)	Weight (kg)	Unit	Fiyat
<p>Alüminyum Üst Ray / Upper Rail</p>	L-3174-1	2.00	6	0,0208	1,588	Adet Pcs	157,00₺
	L-3174-2	2.50		0,0260	1,985		196,00₺
	L-3174-3	3.00		0,0312	2,382		235,00₺
<p>Alüminyum Alt Ray / Bottom Rail</p>	L-3143-1	2.00	20	0,011	0,5700	Adet Pcs	57,00₺
	L-3143-2	2.50		0,03	0,7125		70,00₺
	L-3143-3	3.00		0,036	0,800		84,00₺
<p>Alüminyum Alt Ray Kapak Profili / Bottom Rail Cover Profile</p>	L-3144-1	2.00	40	0,0042	0,1180	Adet Pcs	18,00₺
	L-3144-2	2.50		0,00525	0,1475		22,60₺
	L-3144-3	3.00		0,0063	0,1770		27,00₺
<p>Alüminyum Alt-Üst Ray / Bottom-Upper Rail</p>	L-3110-1	2.00	20	0,024	0,500	Adet Pcs	42,00₺
	L-3110-2	2.50		0,03	0,600		53,00₺
	L-3110-3	3.00		0,036	0,700		63,00₺

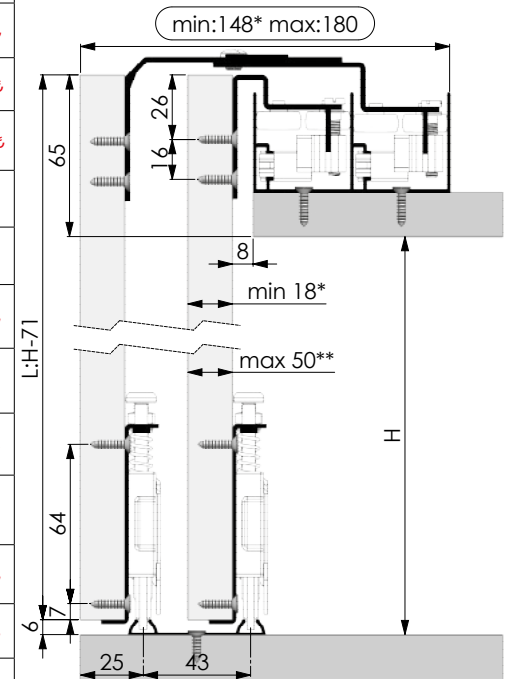



LC58

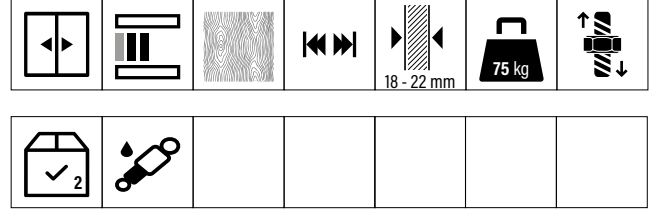

PDF

1 Set İçeriği | 1 Set Includes

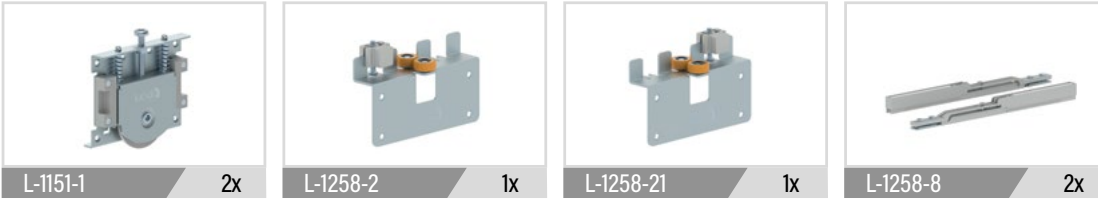

Code	T (mm)	Box	Volume (m³)	Weight (kg)	Birim / Unit	Fiyat
L-1258	18-22	24	0,035	22,3	1Tk - 1 Kapak / 1 Set - 1 Doors	100,00₺

Technical Drawing	Code	T (mt)	Bağ Band	Volume (m³)	Weight (kg)	Unit	Fiyat
<p>Alüminyum Üst Ray / Upper Rail</p>	L-3174-1	2.00	6	0,0208	1,588	Adet Pcs	157,00₺
	L-3174-2	2.50		0,0260	1,985		196,00₺
	L-3174-3	3.00		0,0312	2,382		235,00₺
<p>Alüminyum Alt Ray / Bottom Rail</p>	L-3143-1	2.00	20	0,011	0,5700	Adet Pcs	57,00₺
	L-3143-2	2.50		0,03	0,7125		70,00₺
	L-3143-3	3.00		0,036	0,8		84,00₺
<p>Alüminyum Alt Ray Kapak Profili / Bottom Rail Cover Profile</p>	L-3144-1	2.00	40	0,0042	0,1180	Adet Pcs	18,00₺
	L-3144-2	2.50		0,00525	0,1475		22,60₺
	L-3144-3	3.00		0,0063	0,1770		27,00₺

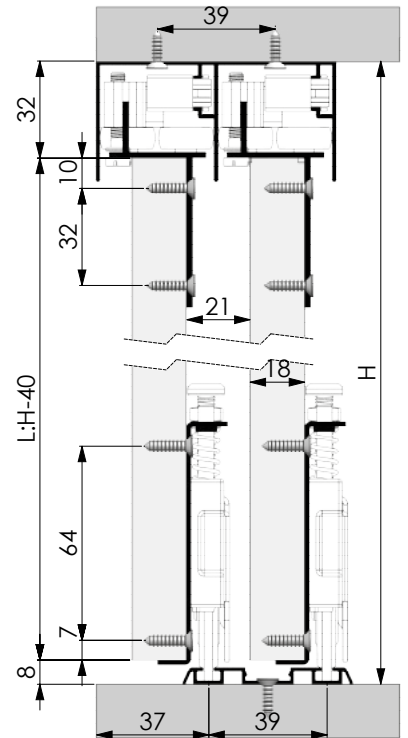

LC75 AY-YLUK

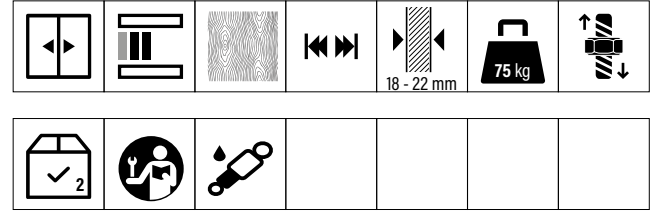

PDF

09

1 Set İçeriği | 1 Set Includes

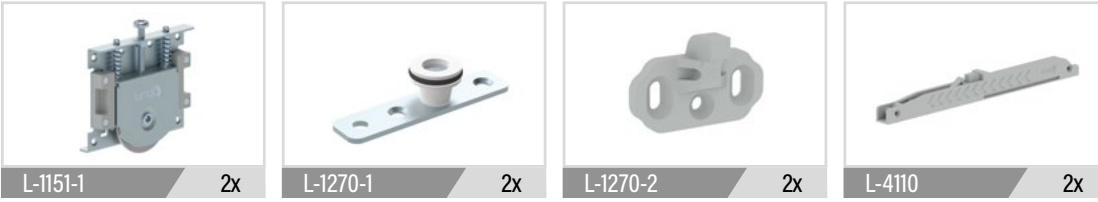

Code	T (mm)	Box	Volume (m³)	Weight (kg)	Birim / Unit	Fiyat
L-1270	18-22	24	0,035	17	1 Tk - 1 Kapak / 1 Set - 1 Doors	68,00₺

Technical Drawing	Code	T (mt)	Bağ Band	Volume (m³)	Weight (kg)	Unit	Fiyat
<p>Alüminyum Üst Ray / Upper Rail</p>	L-3110-1	2.00	20	0,024	0,500	Adet Pcs	42,00₺
	L-3110-2	2.50		0,03	0,600		53,00₺
	L-3110-3	3.00		0,036	0,700		63,00₺
<p>Alüminyum Üst Ray / Upper Rail</p>	L-3178-1	2.00	10	0,015	0,976	Adet Pcs	121,00₺
	L-3178-3	3.00		0,023	1,464		179,00₺

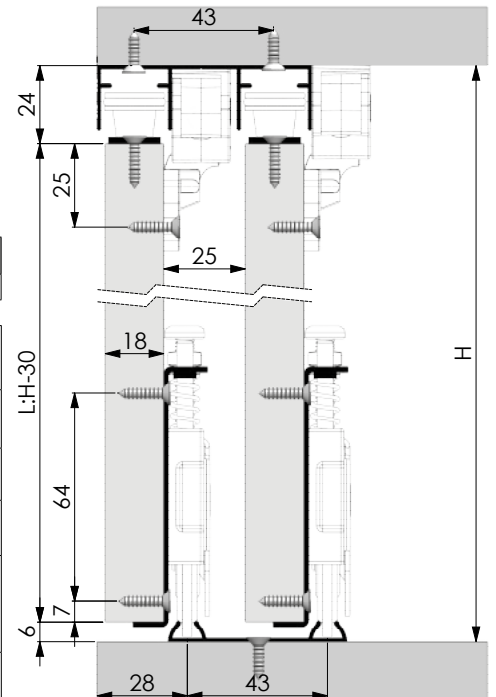



LC75 AY-YLUK-ECO

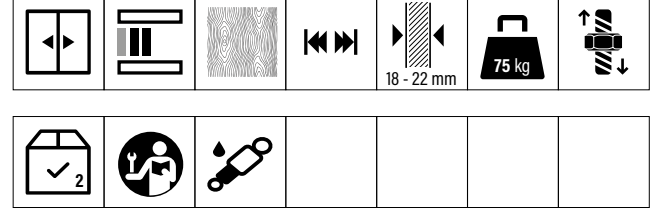

PDF

1 Set İçeriği | 1 Set Includes



L-1272-1

2x

L-1270-1

2x

L-1270-2

1x

L-4110

1x

Code	T (mm)	Box	Volume (m ³)	Weight (kg)	Birim / Unit	Fiyat
L-1271	18-22	24	0,035	13	1 Tk - 1 Kapak / 1 Set - 1 Doors	60,00₺

Technical Drawing	Code	T (mt)	Bağ Band	Volume (m ³)	Weight (kg)	Unit	Fiyat
<p>Alüminyum Üst Ray / Upper Rail</p>	L-3110-1	2.00	20	0,024	0,500	Adet Pcs	42,00₺
	L-3110-2	2.50		0,03	0,600		53,00₺
	L-3110-3	3.00		0,036	0,700		63,00₺
<p>Alüminyum Üst Ray / Upper Rail</p>	L-3178-1	2.00	10	0,015	0,976	Adet Pcs	121,00₺
	L-3178-3	3.00		0,023	1,464		179,00₺

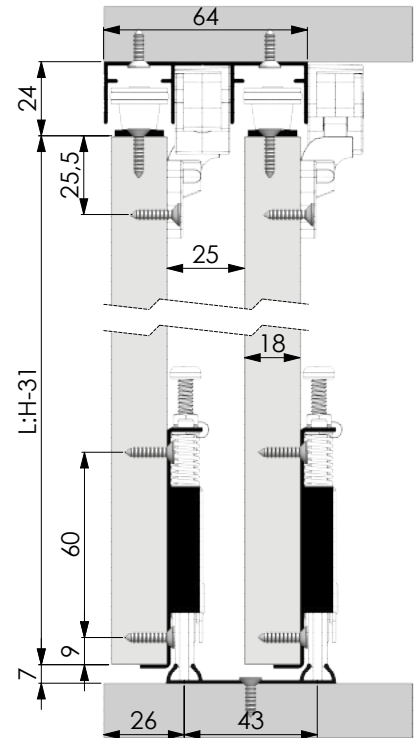

LC75 AY-UK-ECO

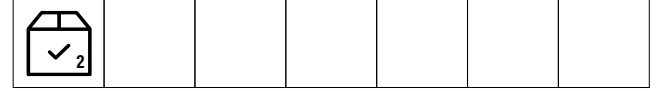
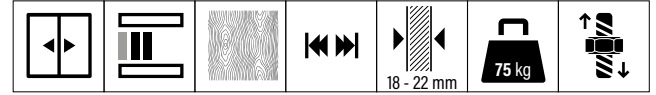

PDF

09

1 Set İçeriği | 1 Set Includes

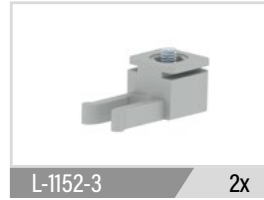

Code	T (mm)	Box	Volume (m³)	Weight (kg)	Birim / Unit	Fiyat
L-1274	18-22	54	0,025	21	1Tk-1 Kapak / 1 Set-1 Doors	30,00₺

Technical Drawing	Code	T (mt)	Bağ Band	Volume (m³)	Weight (kg)	Unit	Fiyat
<p>Alüminyum Üst Ray / Upper Rail</p>	L-3110-1	2.00	20	0,024	0,500	Adet Pcs	42,00₺
	L-3110-2	2.50		0,03	0,600		53,00₺
	L-3110-3	3.00		0,036	0,700		63,00₺
<p>Alüminyum Üst Ray / Upper Rail</p>	L-3123-1	2.00	10	0,015	0,9140	Adet Pcs	90,00₺
	L-3123-2	2.50		0,019	1,1425		112,00₺
	L-3123-3	3.00		0,023	1,3710		135,00₺

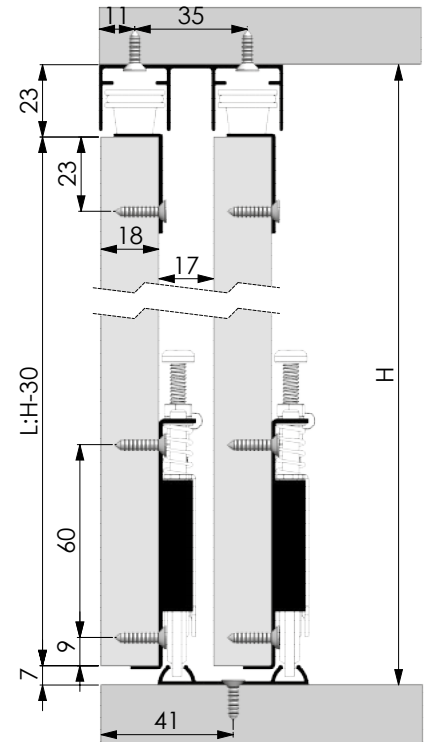



LC65 ÜSTTEN MONTAJ / UPPER MOUNTED

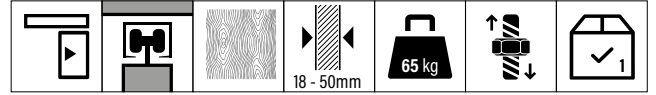

PDF

1 Set İçeriği | 1 Set Includes



Code	T (mm)	Box	Volume (m ³)	Weight (kg)	Birim / Unit	Fiyat
L-2101	18-50	36	0,027	16,7	1Tk -1 Kapak / 1Set -1 Doors	49,00₺

Technical Drawing	Code	T (mt)	Bağ Band	Volume (m ³)	Weight (kg)	Unit	Fiyat
<p>Alüminyum Üst Ray / Upper Rail</p>	L-3127-1	2.00	10	0,0245	0,900	Adet Pcs	105,00₺
	L-3127-3	3.00		0,0288	1,602		157,00₺
<p>PVC Alt Ray / Bottom Rail</p>	L-3703	3.00	50	0,0225	0,200	Adet Pcs	11,40₺

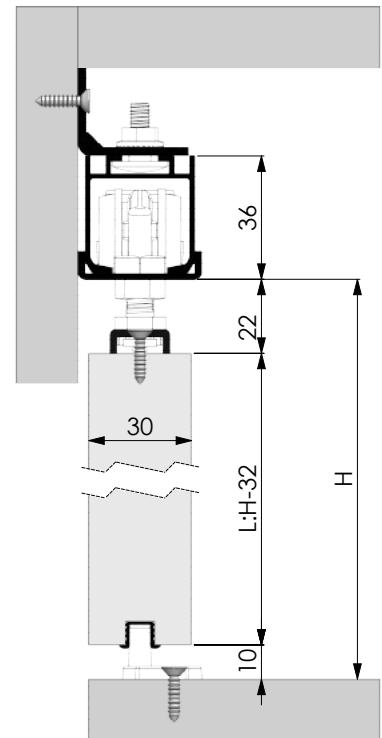

LC65 YANDAN MONTAJ / SIDE MOUNTED

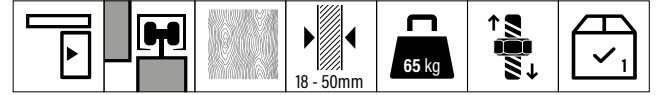

PDF

09

1 Set İçeriği | 1 Set Includes

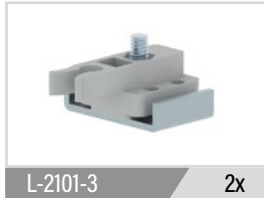

Code	T (mm)	Box	Volume (m³)	Weight (kg)	Birim / Unit	Fiyat
L-2102	18-50	36	0,027	16,7	1Tk - 1 Kapak / 1 Set - 1 Doors	47,00₺

Technical Drawing	Code	T (mt)	Bağ Band	Volume (m³)	Weight (kg)	Unit	Fiyat
<p>Alüminyum Üst Ray / Upper Rail</p>	L-3127-1	2.00	10	0,0245	0,900	Adet Pcs	105,00₺
	L-3127-3	3.00		0,0288	1,602		157,00₺
<p>PVC Alt Ray / Bottom Rail</p>	L-3703	3.00	50	0,0225	0,200	Adet Pcs	11,40₺

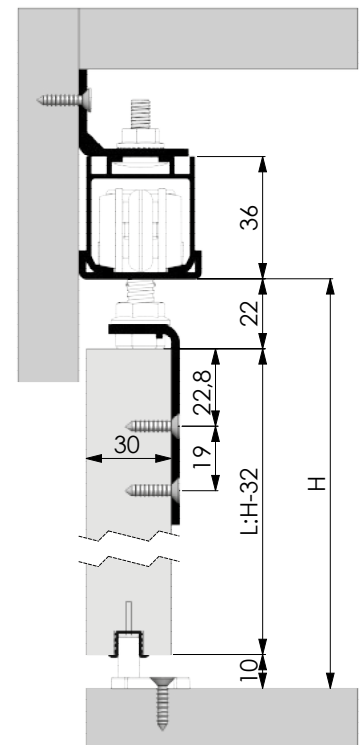



LC99 ÜSTTEN MONTAJ / UPPER MOUNTED

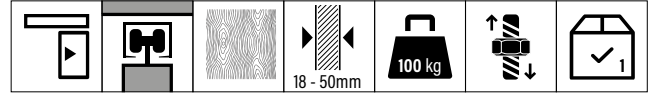

PDF

1 Set İçeriği | 1 Set Includes



Code	T (mm)	Box	Volume (m³)	Weight (kg)	Birim / Unit	Fiyat
L-2111	18-50	36	0,027	27,16	1Tk - 1 Kapak / 1 Set - 1 Doors	69,00₺

Technical Drawing	Code	T (mt)	Bağ Band	Volume (m³)	Weight (kg)	Unit	Fiyat
<p>Alüminyum Üst Ray / Upper Rail</p>	L-3128-1	2.00	10	0,405	1,100	Adet Pcs	120,00₺
	L-3128-3	3.00		0,06075	1,700		180,00₺
<p>PVC Alt Ray / Bottom Rail</p>	L-3703	3.00	50	0,0225	0,200	Adet Pcs	11,40₺

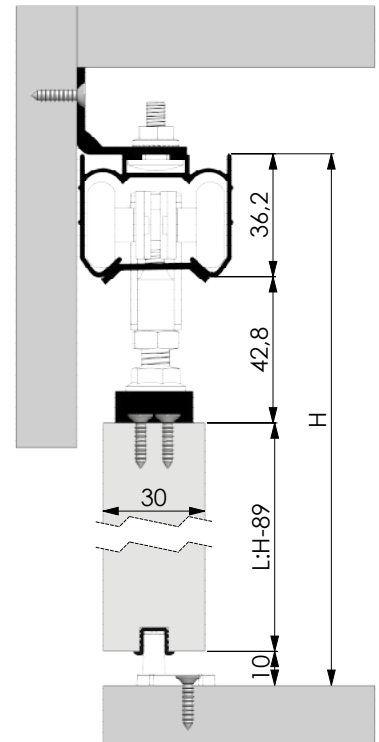

LC99 YANDAN MONTAJ / SIDE MOUNTED

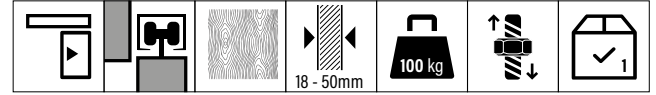

PDF

09

1 Set İeriđi | 1 Set Includes

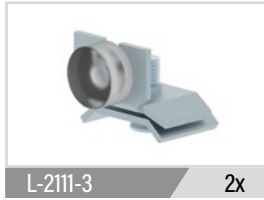

Code	T (mm)	Box	Volume (m ³)	Weight (kg)	Birim / Unit	Fiyat
L-2112	18-50	36	0,027	27,16	1Tk - 1 Kapak / 1 Set - 1 Doors	69,00₺

Technical Drawing	Code	T (mt)	Bađ Band	Volume (m ³)	Weight (kg)	Unit	Fiyat
<p>Alüminyum Üst Ray / Upper Rail</p>	L-3128-1	2.00	10	0,405	1,100	Adet Pcs	120,00₺
	L-3128-3	3.00		0,06075	1,700		180,00₺
<p>PVC Alt Ray / Bottom Rail</p>	L-3703	3.00	50	0,0225	0,200	Adet Pcs	11,40₺

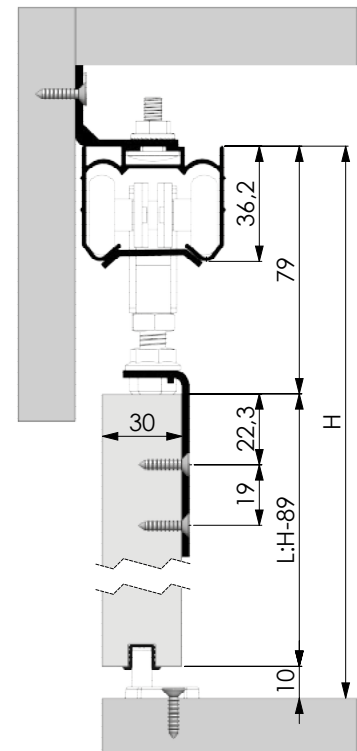



LC120 TEK YAVAŞLATICI / WITH SINGLE SOFT CLOSING

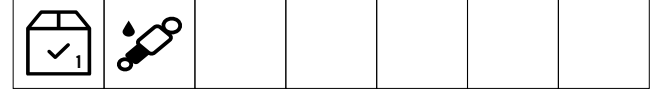
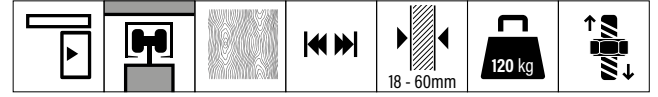

PDF

1 Set İçeriği | 1 Set Includes

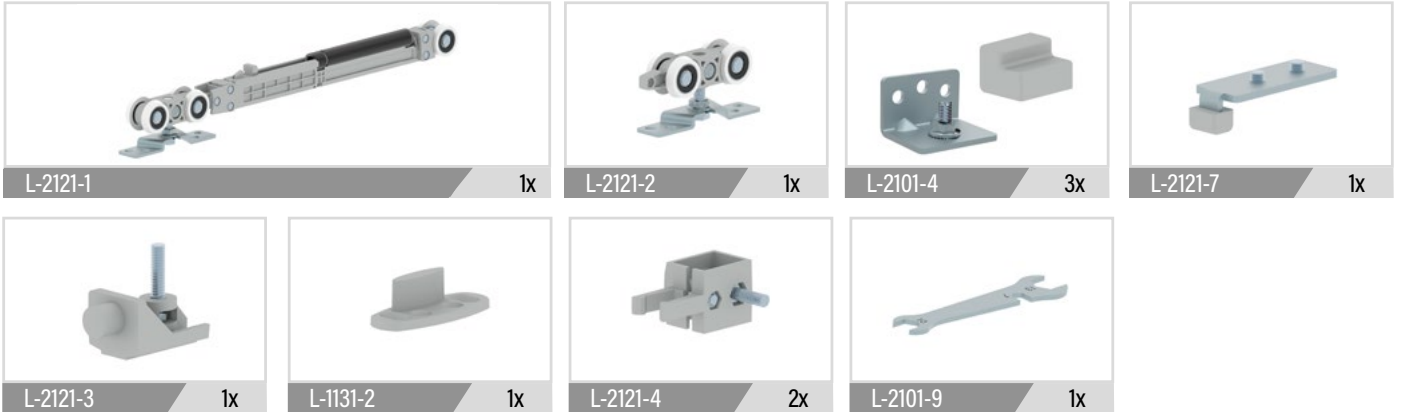

Code	T (mm)	Box	Volume (m ³)	Weight (kg)	Birim / Unit	Fiyat
L-2121	18-60	20	0,063	16,4	1Tk - 1 Kapak / 1 Set - 1 Doors	145,00₺

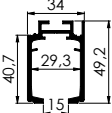
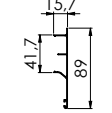
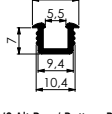
Technical Drawing	Code	T (mt)	Bağ Band	Volume (m ³)	Weight (kg)	Unit	Fiyat
 <p>Alüminyum Üst Ray / Upper Rail</p>	L-3175-1	2.00	8	0,0216	2,232	Adet Pcs	197,00₺
	L-3175-3	3.00		0,0324	3,348		296,00₺
	L-3175-4	4.00		0,0432	4,464		392,00₺
 <p>Alüminyum Alt Ray / Bottom Rail</p>	L-3176-1	2.00	10	0,0162	0,768	Adet Pcs	76,00₺
	L-3176-3	3.00		0,0243	1,152		113,00₺
 <p>PVC Alt Ray / Bottom Rail</p>	L-3703	3.00	50	0,0225	0,200	Adet Pcs	11,40₺

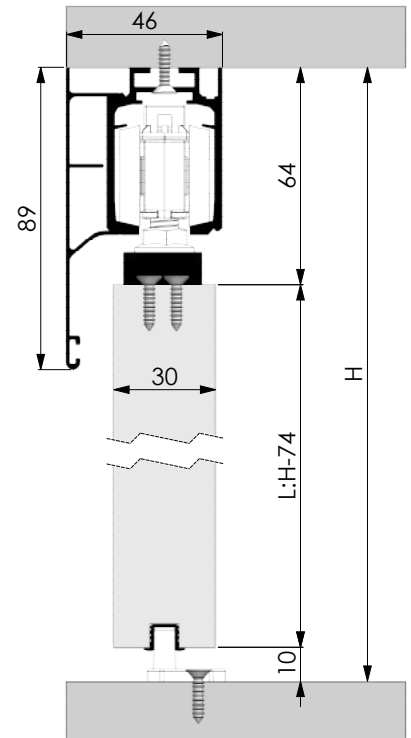

LC120 ÇİFT YAVAŞLATICI / WITH DOUBLE SOFT CLOSING

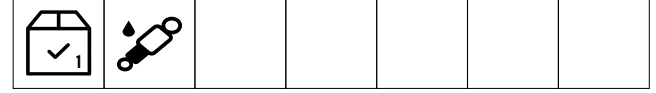
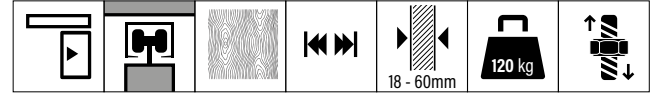

PDF

09

1 Set İçeriği | 1 Set Includes

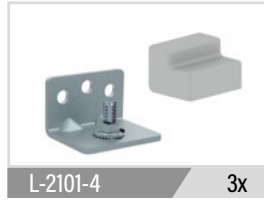

Code	T (mm)	Box	Volume (m³)	Weight (kg)	Birim / Unit	Fiyat
L-2122	18-60	20	0,063	18,9	1Tk - 1 Kapak / 1 Set - 1 Doors	196,00₺

Technical Drawing	Code	T (mt)	Bağ Band	Volume (m³)	Weight (kg)	Unit	Fiyat
<p>Alüminyum Üst Ray / Upper Rail</p>	L-3175-1	2.00	8	0,0216	2,232	Adet Pcs	197,00₺
	L-3175-3	3.00		0,0324	3,348		296,00₺
	L-3175-4	4.00		0,0432	4,464		392,00₺
<p>Alüminyum Alt Ray / Bottom Rail</p>	L-3176-1	2.00	10	0,0162	0,768	Adet Pcs	76,00₺
	L-3176-3	3.00		0,0243	1,152		113,00₺
<p>PVC Alt Ray / Bottom Rail</p>	L-3703	3.00	50	0,0225	0,200	Adet Pcs	11,40₺

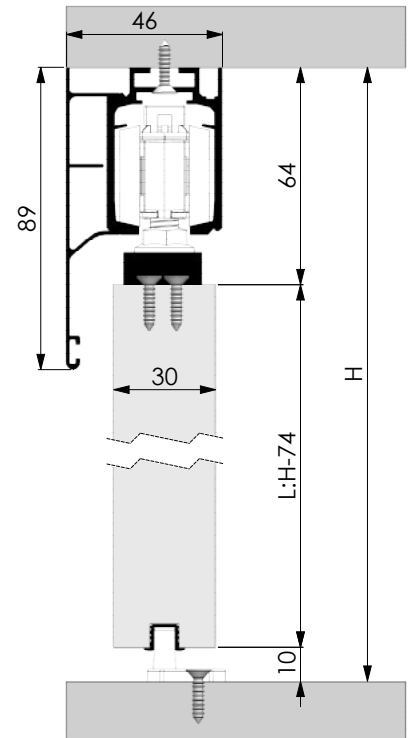

L-4101 MASA PİMİ / TABLE PIN

L-4113 HAREKETLİ TABLA DESTEK ELEMANI / MOVING TABLE SUPPORT PART

1 Set İçeriği | 1 Set Includes



1 Set İçeriği | 1 Set Includes



Code	T (mm)	Box	Volume (m³)	Weight (kg)	Birim / Unit	Fiyat
L-4101	-	1000	0,0096	8,7	1 Adet / 1 Piece	2,20₺

Code	T (mm)	Box	Volume (m³)	Weight (kg)	Birim / Unit	Fiyat
L-4113	-	500	0,035	20	1 Adet / 1 Piece	5,30₺

09

L-4102 HALATLI MASA RAYI MONTAJ ELEMANLARI / TABLE RAIL MECHANISM WITH STEEL ROPE MOUNTING ELEMENTS

1 Set İçeriği | 1 Set Includes



Code	T (mm)	Box	Volume (m³)	Weight (kg)	Birim / Unit	Fiyat
L-4102	-	120	0,035	31,85	1Tk / 1 Set	28,00₺

L-4111 METAL ÇEK-GER APARATI / METAL PULL TENSION

1 Set İçeriği | 1 Set Includes

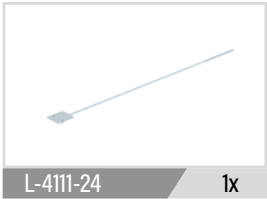

Code	T (mm)	Box	Volume (m³)	Weight (kg)	Birim / Unit	Fiyat
L-4111	-	40	0,404	36	1Tk / 1 Set	48,00₺

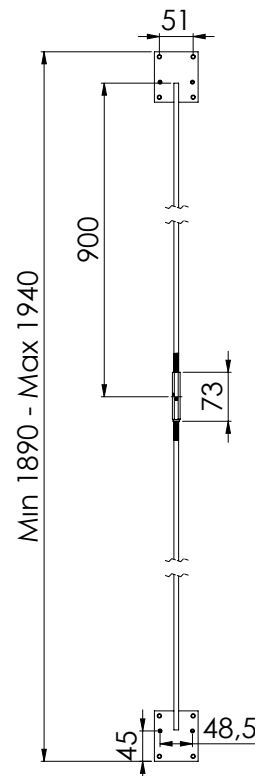

HALATLI MASA RAYI TAKIMI / TABLE RAIL SET WITH STEEL ROPE



09

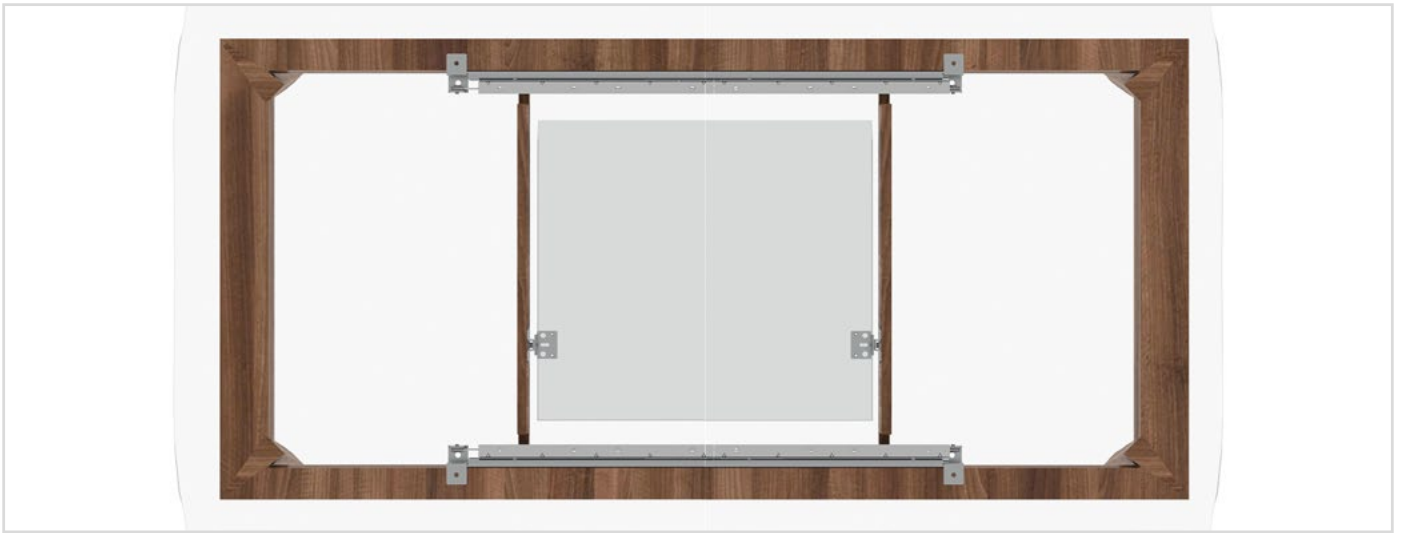

1 Set İeriđi | 1 Set Includes

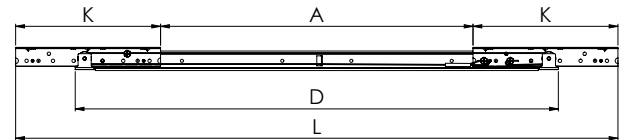

Code	Box	Volume (m ³)	Weight (kg)	Birim / Unit	Fiyat
L-4103	10	0,0272	19	1Tk / 1 Set	119,00₺
L-4106	10	0,0272	24	1Tk / 1 Set	133,00₺
L-4115	10	0,0311	27,5	1Tk / 1 Set	155,00₺

Code	D	K	A	L
L-4103	770	230	500	960
L-4106	770	350	500	1200
L-4115	1050	350	720	1415

ASANSÖRLÜ MASA RAYI TAKIMI / TABLE RAIL SET WITH LIFT

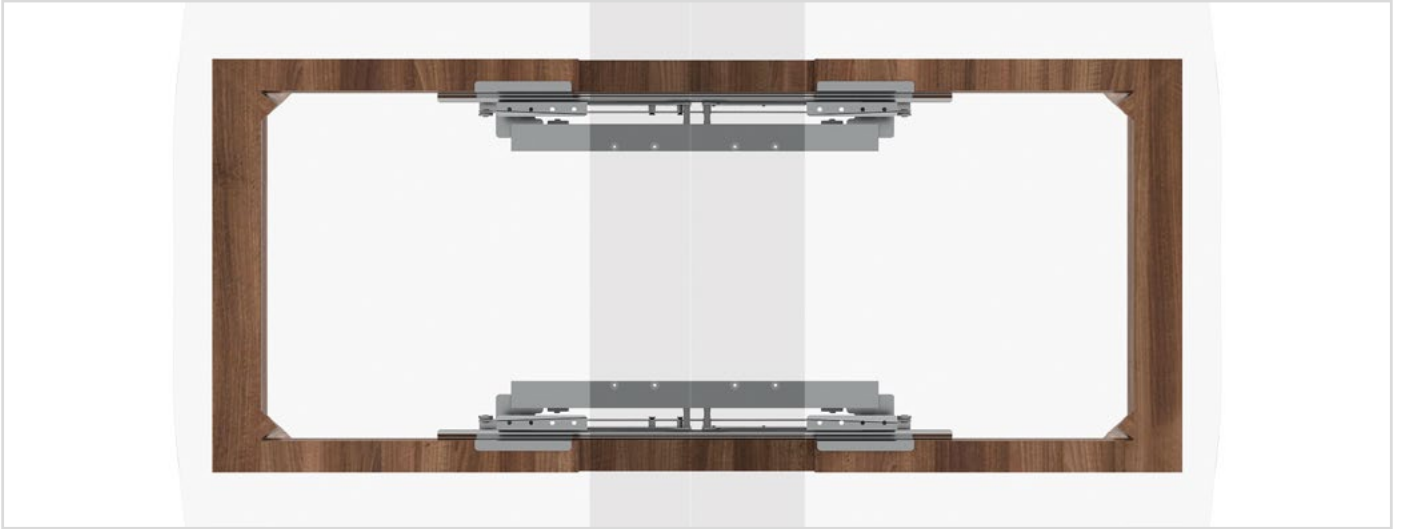

1 Set İçeriği | 1 Set Includes

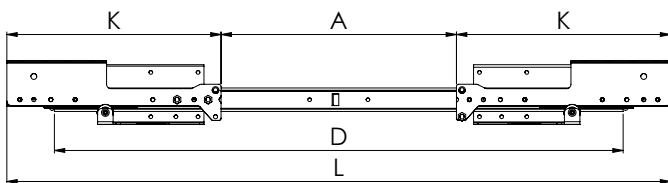
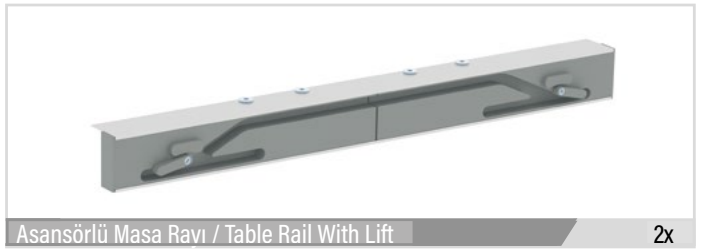
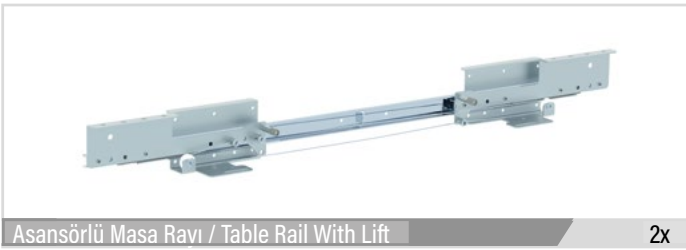

Code	Mode Tray (mm)	Box	Volume (m³)	Weight (kg)	Birim / Unit	Fiyat
L-4114	285	2	0,0315	7800	1Tk / 1 Set	381,00₺
L-4116	450	2	0,0370	9,000	1Tk / 1 Set	458,00₺

Code	D	K	A	L
L-4114	770	290	490	1070
L-4116	1070	290	605	1186

L-4109 YAVAŞLATICI / SOFT CLOSING MECHANISM

1 Set İçeriği | 1 Set Includes

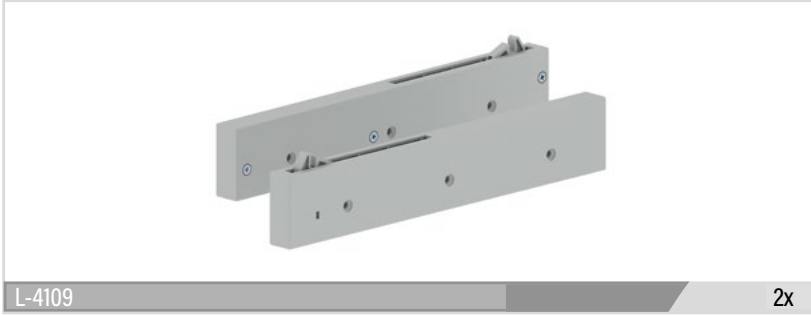

L-4109

2x



L-4109-4

1x



L-4109-5

1x

Code	T (mm)	Box	Volume (m ³)	Weight (kg)	Birim / Unit	Fiyat
L-4109	-	40	0,065	24,7	1Tk / 1Set	107,00₺

09

L-4110 YAVAŞLATICI / SOFT CLOSING MECHANISM

1 Set İçeriği | 1 Set Includes

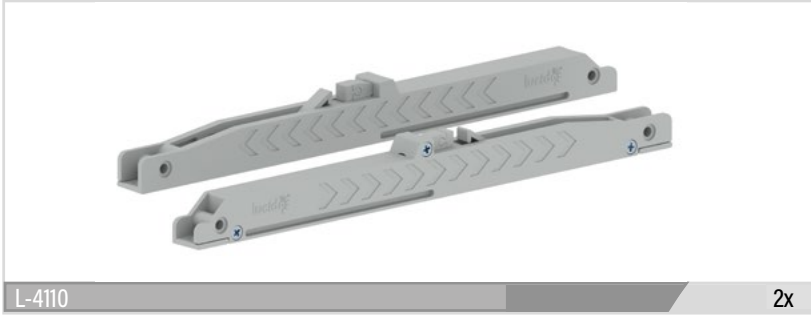

L-4110

2x

Code	T (mm)	Box	Volume (m ³)	Weight (kg)	Birim / Unit	Fiyat
L-4110	-	65	0,035	10	1Tk / 1Set	65,00₺

L-1258-8 YAVAŞLATICI / SOFT CLOSING MECHANISM

1 Set İçeriği | 1 Set Includes

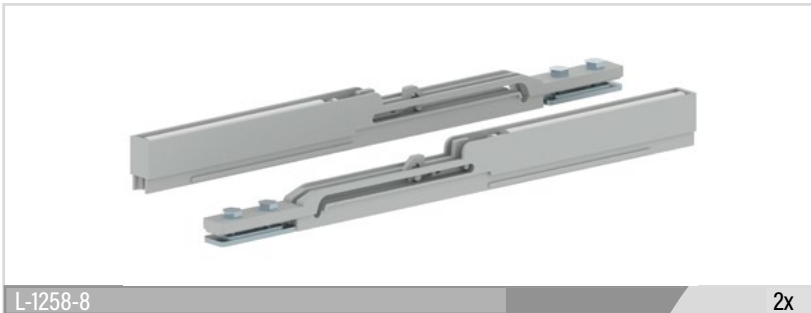

L-1258-8

2x

Code	T (mm)	Box	Volume (m ³)	Weight (kg)	Birim / Unit	Fiyat
L-1258-8	-	200	0,0315	22,3	1Tk / 1Set	44,00₺

© Copyright 2021

Bu broşür STAR MUTFAK ve MOBİLYA AKSESUARLARI SAN. ve TİC. A.Ş. tarafından ürün tanıtımı için hazırlanmıştır. Yazılı izin olmaksızın tamamı veya bir bölümü kopyalanamaz. STAR MUTFAK tüm ürünlerinde önceden haber vermeksizin değişiklik yapma hakkını saklı tutar.

This brochure; prepared by STAR MUTFAK ve MOBİLYA AKSESUARLARI SAN. ve TİC. A.Ş. is for presentation of products. Can not be copied all or partly without written permission. STAR MUTFAK reserve the right to make changes for all products without prior notice.

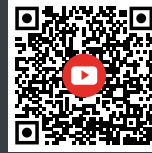

STAR MUTFAK ve MOBİLYA AKSESUARLARI SAN. TİC. A.Ş.

Velimeşe OSB Mah. 236. Sokak No:18 Ergene 59930 Tekirdağ Turkey

Tel: +90 282 444 53 54 **Fax:** +90 282 502 63 80

www.starax.com.tr

www.lucido.com.tr