

# DOMODEK®



**Metal mutfak aksesuarları kiler, banyo, gardrop ve bar sistemleri**  
*Metal kitchen accessories pantry, bathroom, wardrop and bar systems*



**GEÇİD**

**ÜRÜN KATALOĞU / PRODUCTS CATALOG**

# Teleskopik kiler grubu / Telescopic pantry group

## Standart Sepet / Standart Basket

## RENK SEÇENEKLERİ

KROM  
KOD XXXXX

ANTRASİT  
KOD XXXXX-A

Ürün Kodu / Product Code	Ürün Adı / Product Name	Sepet / Basket	Ölçüler / Size GxDxY / WxDxH (mm)	Modül / Modul (mm)	Hacim / Volume (m3)	Ağırlık / Weight (kg)	Fiyat / Price (₺)
966030	60 - 80 cm	2	230 x 500 x 600 - 800	300	0,07	9,60	515
966035	60 - 80 cm	2	280 x 500 x 600 - 800	350	0,07	9,99	515
966040	60 - 80 cm	2	330 x 500 x 600 - 800	400	0,07	10,38	515
966045	60 - 80 cm	2	380 x 500 x 600 - 800	450	0,07	10,75	515
966050	60 - 80 cm	2	430 x 500 x 600 - 800	500	0,07	11,11	515
968530	85 - 110 cm	3	230 x 500 x 850 - 1100	300	0,12	11,08	590
968535	85 - 110 cm	3	280 x 500 x 850 - 1100	350	0,12	11,60	590
968540	85 - 110 cm	3	330 x 500 x 850 - 1100	400	0,12	12,14	590
968545	85 - 110 cm	3	380 x 500 x 850 - 1100	450	0,12	12,70	590
968550	85 - 110 cm	3	430 x 500 x 850 - 1100	500	0,12	13,23	590
961130	110 - 125 cm	4	230 x 500 x 1100 - 1250	300	0,13	12,47	675
961135	110 - 125 cm	4	280 x 500 x 1100 - 1250	350	0,13	13,12	675
961140	110 - 125 cm	4	330 x 500 x 1100 - 1250	400	0,13	13,80	675
961145	110 - 125 cm	4	380 x 500 x 1100 - 1250	450	0,13	14,59	675
961150	110 - 125 cm	4	430 x 500 x 1100 - 1250	500	0,13	15,22	675
961230	125 - 140 cm	4	230 x 500 x 1250 - 1400	300	0,15	12,80	695
961235	125 - 140 cm	4	280 x 500 x 1250 - 1400	350	0,15	13,45	695
961240	125 - 140 cm	4	330 x 500 x 1250 - 1400	400	0,15	14,16	695
961245	125 - 140 cm	4	380 x 500 x 1250 - 1400	450	0,15	14,92	695
961250	125 - 140 cm	4	430 x 500 x 1250 - 1400	500	0,15	15,54	695
961430	140 - 155 cm	5	230 x 500 x 1400 - 1550	300	0,17	14,06	805
961435	140 - 155 cm	5	280 x 500 x 1400 - 1550	350	0,17	14,85	805
961440	140 - 155 cm	5	330 x 500 x 1400 - 1550	400	0,17	15,72	805
961445	140 - 155 cm	5	380 x 500 x 1400 - 1550	450	0,17	16,70	805
961450	140 - 155 cm	5	430 x 500 x 1400 - 1550	500	0,17	17,46	805
961530	155 - 170 cm	5	230 x 500 x 1550 - 1700	300	0,18	14,23	855
961535	155 - 170 cm	5	280 x 500 x 1550 - 1700	350	0,18	15,02	855
961540	155 - 170 cm	5	330 x 500 x 1550 - 1700	400	0,18	15,86	855
961545	155 - 170 cm	5	380 x 500 x 1550 - 1700	450	0,18	16,87	855
961550	155 - 170 cm	5	430 x 500 x 1550 - 1700	500	0,18	17,63	855
961730	170 - 185 cm	6	230 x 500 x 1700 - 1850	300	0,20	15,95	935
961735	170 - 185 cm	6	280 x 500 x 1700 - 1850	350	0,20	16,88	935
961740	170 - 185 cm	6	330 x 500 x 1700 - 1850	400	0,20	17,96	935
961745	170 - 185 cm	6	380 x 500 x 1700 - 1850	450	0,20	19,22	935
961750	170 - 185 cm	6	430 x 500 x 1700 - 1850	500	0,20	20,09	935
961830	185 - 200 cm	6	230 x 500 x 1850 - 2000	300	0,22	16,13	965
961835	185 - 200 cm	6	280 x 500 x 1850 - 2000	350	0,22	17,06	965
961840	185 - 200 cm	6	330 x 500 x 1850 - 2000	400	0,22	18,14	965
961845	185 - 200 cm	6	380 x 500 x 1850 - 2000	450	0,22	19,40	965
961850	185 - 200 cm	6	430 x 500 x 1850 - 2000	500	0,22	20,27	965
962030	200 - 215 cm	7	230 x 500 x 2000 - 2150	300	0,23	17,43	1115
962035	200 - 215 cm	7	280 x 500 x 2000 - 2150	350	0,23	18,49	1115
962040	200 - 215 cm	7	330 x 500 x 2000 - 2150	400	0,23	19,73	1115
962045	200 - 215 cm	7	380 x 500 x 2000 - 2150	450	0,23	21,18	1115
962050	200 - 215 cm	7	430 x 500 x 2000 - 2150	500	0,23	22,25	1115
TEK SEPET / SINGLE BASKET							120

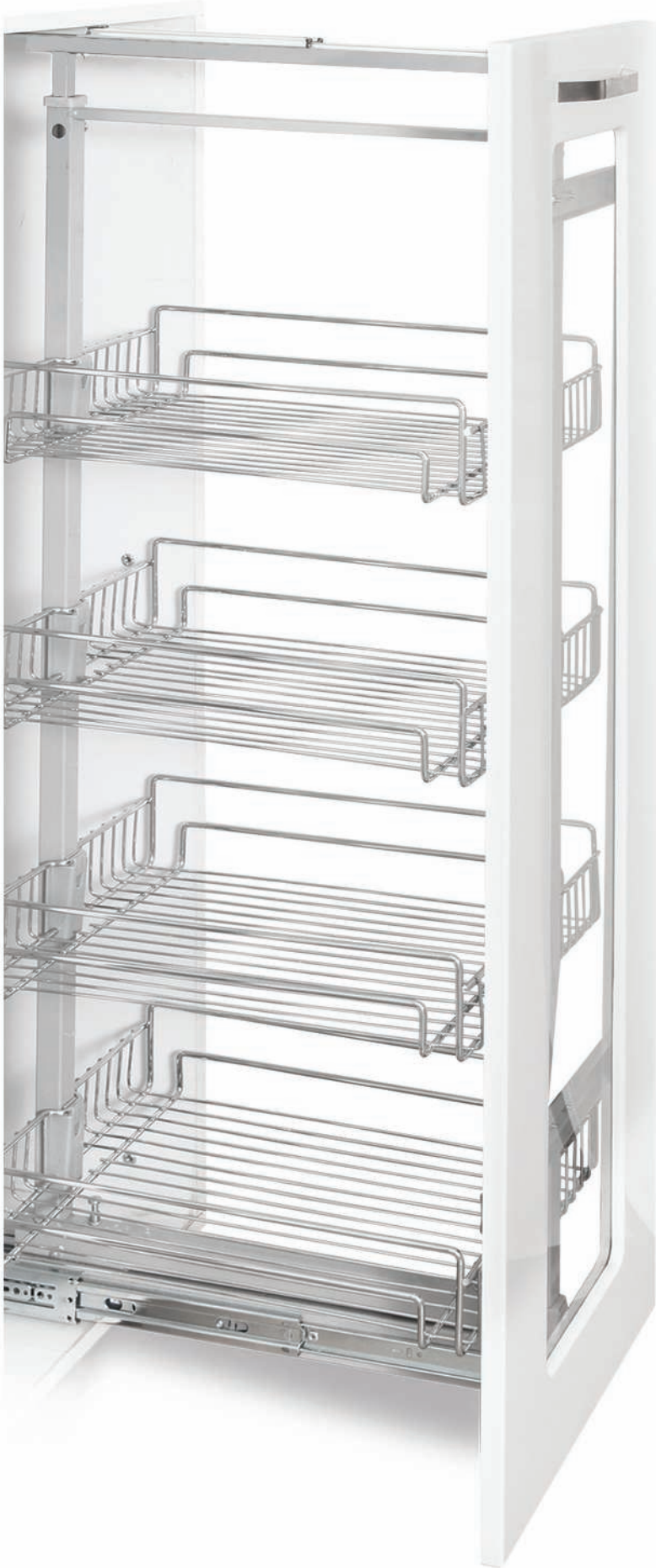

- Alt ve üst mekanizmalarda bilyeli teleskopik ray kullanılmıştır.
- Taşıma kapasitesi sepet başı maksimum 15kg' dır.
- Gövde uzunluğu, modül yüksekliğine uygun ayarlanabilir.
- Sepetler 5 farklı ölçüsü ile modül genişliğine uygundur.
- Alt ve üst mekanizmalar ve gövde gri boyalı, sepetler krom kaplamalıdır.

- Ball bearing telescopic rails are used in the bottom and top mechanisms.
- Carrying capacity is max. 15kg for each basket.
- Body length can be adjusted according to the height of the module.
- Five different size of baskets are appropriate to the width of the module.
- Bottom and top mechanisms and body are painted grey, baskets are chrome plated.





## Frenli kiler grubu / Soft close pantry group

# SOFT CLOSE (Frenli)

### RENK SEÇENEKLERİ

KROM  
KOD XXXXX

ANTRASİT  
KOD XXXXX-A

Frenli kiler grubu / Soft close pantry units

Standart Sepet / Standard Basket

Ürün Kodu / Product Code	Ürün Adı / Product Name	Sepet / Basket	Ölçüler / Size GxDxY / WxDxH (mm)	Modül / Modul (mm)	Hacim / Volume (m3)	Ağırlık / Weight (kg)	Fiyat / Price (₺)
976030	60 - 80 cm	2	230 x 500 x 600 - 800	300	0,07	15,60	910
976035	60 - 80 cm	2	280 x 500 x 600 - 800	350	0,07	15,99	910
976040	60 - 80 cm	2	330 x 500 x 600 - 800	400	0,07	16,38	910
976045	60 - 80 cm	2	380 x 500 x 600 - 800	450	0,07	16,75	910
976050	60 - 80 cm	2	430 x 500 x 600 - 800	500	0,07	17,11	910
978530	85 - 110 cm	3	230 x 500 x 850 - 1100	300	0,12	17,08	1035
978535	85 - 110 cm	3	280 x 500 x 850 - 1100	350	0,12	17,60	1035
978540	85 - 110 cm	3	330 x 500 x 850 - 1100	400	0,12	18,14	1035
978545	85 - 110 cm	3	380 x 500 x 850 - 1100	450	0,12	18,70	1035
978550	85 - 110 cm	3	430 x 500 x 850 - 1100	500	0,12	19,23	1035
971130	110 - 125 cm	4	230 x 500 x 1100 - 1250	300	0,13	18,47	1150
971135	110 - 125 cm	4	280 x 500 x 1100 - 1250	350	0,13	19,12	1150
971140	110 - 125 cm	4	330 x 500 x 1100 - 1250	400	0,13	19,80	1150
971145	110 - 125 cm	4	380 x 500 x 1100 - 1250	450	0,13	20,59	1150
971150	110 - 125 cm	4	430 x 500 x 1100 - 1250	500	0,13	21,22	1150
971230	125 - 140 cm	4	230 x 500 x 1250 - 1400	300	0,15	18,80	1185
971235	125 - 140 cm	4	280 x 500 x 1250 - 1400	350	0,15	19,45	1185
971240	125 - 140 cm	4	330 x 500 x 1250 - 1400	400	0,15	20,16	1185
971245	125 - 140 cm	4	380 x 500 x 1250 - 1400	450	0,15	20,92	1185
971250	125 - 140 cm	4	430 x 500 x 1250 - 1400	500	0,15	21,54	1185
971430	140 - 155 cm	5	230 x 500 x 1400 - 1550	300	0,17	20,06	1300
971435	140 - 155 cm	5	280 x 500 x 1400 - 1550	350	0,17	20,85	1300
971440	140 - 155 cm	5	330 x 500 x 1400 - 1550	400	0,17	21,72	1300
971445	140 - 155 cm	5	380 x 500 x 1400 - 1550	450	0,17	22,70	1300
971450	140 - 155 cm	5	430 x 500 x 1400 - 1550	500	0,17	23,46	1300
971530	155 - 170 cm	5	230 x 500 x 1550 - 1700	300	0,18	20,23	1330
971535	155 - 170 cm	5	280 x 500 x 1550 - 1700	350	0,18	21,02	1330
971540	155 - 170 cm	5	330 x 500 x 1550 - 1700	400	0,18	21,88	1330
971545	155 - 170 cm	5	380 x 500 x 1550 - 1700	450	0,18	22,87	1330
971550	155 - 170 cm	5	430 x 500 x 1550 - 1700	500	0,18	23,63	1330
971730	170 - 185 cm	6	230 x 500 x 1700 - 1850	300	0,20	21,95	1455
971735	170 - 185 cm	6	280 x 500 x 1700 - 1850	350	0,20	22,68	1455
971740	170 - 185 cm	6	330 x 500 x 1700 - 1850	400	0,20	23,96	1455
971745	170 - 185 cm	6	380 x 500 x 1700 - 1850	450	0,20	25,22	1455
971750	170 - 185 cm	6	430 x 500 x 1700 - 1850	500	0,20	26,09	1455
971830	185 - 200 cm	6	230 x 500 x 1850 - 2000	300	0,22	22,13	1535
971835	185 - 200 cm	6	280 x 500 x 1850 - 2000	350	0,22	23,06	1535
971840	185 - 200 cm	6	330 x 500 x 1850 - 2000	400	0,22	24,14	1535
971845	185 - 200 cm	6	380 x 500 x 1850 - 2000	450	0,22	25,40	1535
971850	185 - 200 cm	6	430 x 500 x 1850 - 2000	500	0,22	26,27	1535
972030	200 - 215 cm	7	230 x 500 x 2000 - 2150	300	0,23	23,43	1635
972035	200 - 215 cm	7	280 x 500 x 2000 - 2150	350	0,23	24,49	1635
972040	200 - 215 cm	7	330 x 500 x 2000 - 2150	400	0,23	25,73	1635
972045	200 - 215 cm	7	380 x 500 x 2000 - 2150	450	0,23	27,18	1635
972050	200 - 215 cm	7	430 x 500 x 2000 - 2150	500	0,23	28,25	1635
TEK SEPET / SINGLE BASKET							120



## Kiler sistemleri grubu / Pantry units

**SSSS** SOFT CLOSE (Frenli)



TSEK

DOMODEK®

**2** years  
guarantee

## Ahşap tabanlı lüks frenli kiler grubu / Wooden based lux soft close pantry group



- Sepet tabanları 18mm MDFLAM' dır.
- Taşıma kapasitesi maksimum 50 kg' dır.
- Gövde uzunluğu, kabin yüksekliğine uygun olarak ayarlanabilir.
- Sepetler 7 farklı ölçüsü ile istediğiniz modül genişliğine uygundur.
- İster menteşeli kapakla ister ürüne monte kapakla kullanılabilir

- *Basket floors are made of 18mm MDF.*
- *Carrying capacity is 50 kg.*
- *Height of the body can be adjusted according to the height of the cabinet.*
- *Sevendifferent size of baskets are appropriate to the width of the modüle.*
- *Available hinged cabinets with door or mounted module covers.*



### RENK SEÇENEKLERİ

KROM  
KOD XXXXX

ANTRASİT  
KOD XXXXX-A

### Ahşap tabanlı lüks frenli kiler grubu / Wooden based lux soft close pantry group

Ürün Kodu / Product Code	Sepet / Basket	Ölçüler / Size GxDxY / WxDxH (mm)	Modül / Modul (mm)	Hacim / Volume (m3)	Ağırlık / Weight (kg)	Fiyat / Price (₺)
92916	2	150 x 500 x 700 - 850	200	0,09	12,00	1405
92917	2	200 x 500 x 700 - 850	250	0,09	12,50	1405
92911	2	250 x 500 x 700 - 850	300	0,09	12,90	1405
92912	2	300 x 500 x 700 - 850	350	0,09	13,50	1405
92913	2	350 x 500 x 700 - 850	400	0,09	14,10	1405
92914	2	400 x 500 x 700 - 850	450	0,09	14,70	1405
92915	2	450 x 500 x 700 - 850	500	0,09	15,30	1405
92926	3	150 x 500 x 850 - 1100	200	0,12	14,50	1495
92927	3	200 x 500 x 850 - 1100	250	0,12	15,30	1495
92921	3	250 x 500 x 850 - 1100	300	0,12	15,80	1495
92922	3	300 x 500 x 850 - 1100	350	0,12	16,40	1495
92923	3	350 x 500 x 850 - 1100	400	0,12	17,00	1495
92924	3	400 x 500 x 850 - 1100	450	0,12	17,60	1495
92925	3	450 x 500 x 850 - 1100	500	0,12	18,20	1495
92936	4	150 x 500 x 1250 - 1400	200	0,14	19,00	1630
92937	4	200 x 500 x 1250 - 1400	250	0,14	19,50	1630
92931	4	250 x 500 x 1250 - 1400	300	0,14	20,00	1630
92932	4	300 x 500 x 1250 - 1400	350	0,14	20,60	1630
92933	4	350 x 500 x 1250 - 1400	400	0,14	21,20	1630
92934	4	400 x 500 x 1250 - 1400	450	0,14	21,80	1630
92935	4	450 x 500 x 1250 - 1400	500	0,14	22,40	1630
92946	5	150 x 500 x 1550 - 1700	200	0,17	23,00	1820
92947	5	200 x 500 x 1550 - 1700	250	0,17	23,50	1820
92941	5	250 x 500 x 1550 - 1700	300	0,17	23,90	1820
92942	5	300 x 500 x 1550 - 1700	350	0,17	24,50	1820
92943	5	350 x 500 x 1550 - 1700	400	0,17	25,10	1820
92944	5	400 x 500 x 1550 - 1700	450	0,17	25,70	1820
92945	5	450 x 500 x 1550 - 1700	500	0,17	26,30	1820
92956	6	150 x 500 x 1850 - 2000	200	0,21	33,00	1965
92957	6	200 x 500 x 1850 - 2000	250	0,21	33,80	1965
92951	6	250 x 500 x 1850 - 2000	300	0,21	34,2	1965
92952	6	300 x 500 x 1850 - 2000	350	0,21	36,5	1965
92953	6	350 x 500 x 1850 - 2000	400	0,21	38,5	1965
92954	6	400 x 500 x 1850 - 2000	450	0,21	40,5	1965
92955	6	450 x 500 x 1850 - 2000	500	0,21	42,5	1965
92966	7	150 x 500 x 2000 - 2150	200	0,25	45,50	2165
92967	7	200 x 500 x 2000 - 2150	250	0,25	46,00	2165
92961	7	250 x 500 x 2000 - 2150	300	0,25	46,5	2165
92962	7	300 x 500 x 2000 - 2150	350	0,25	48,5	2165
92963	7	350 x 500 x 2000 - 2150	400	0,25	50,5	2165
92964	7	400 x 500 x 2000 - 2150	450	0,25	52,5	2165
92965	7	450 x 500 x 2000 - 2150	500	0,25	54,5	2165

TSEK

DOMODEK®



## İKİZ KİLER GRUBU / TWİNCE PANTRY UNITS

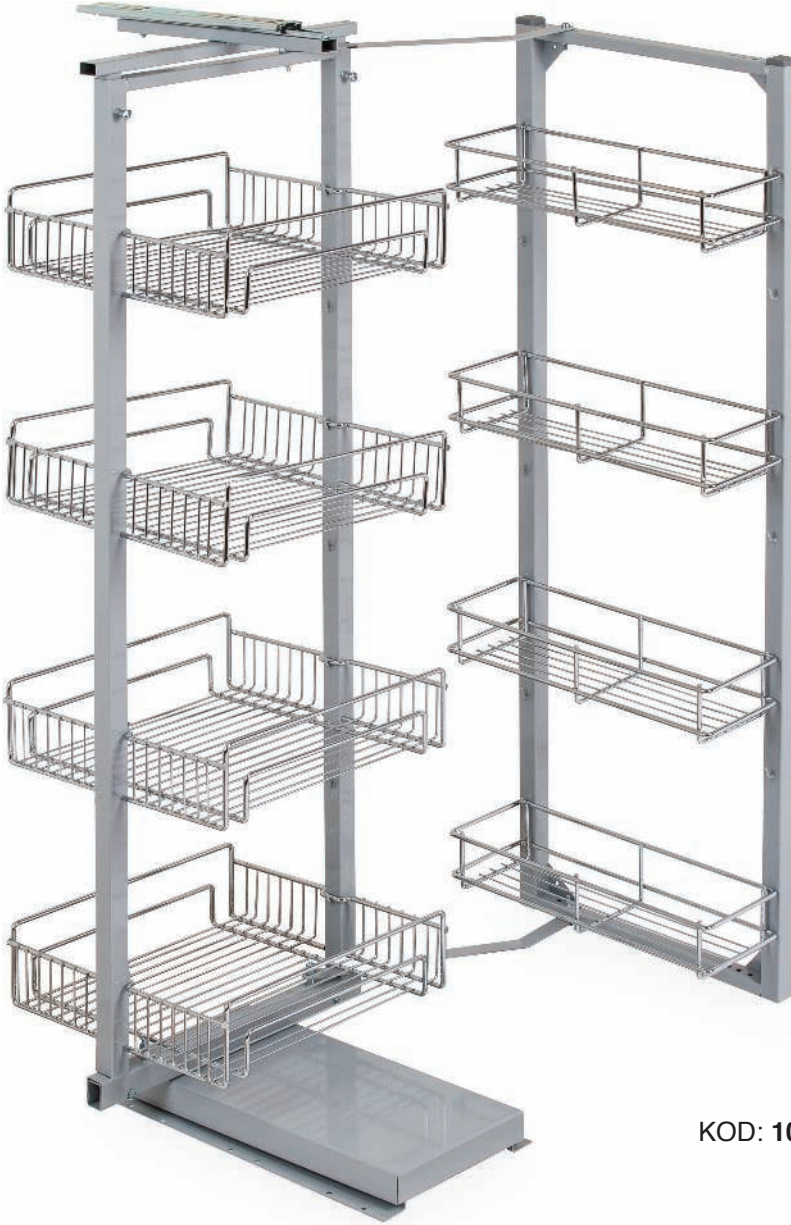

KOD: 10205

- Alt ve üst mekanizmalarda bilyeli teleskopik ray kullanılmıştır.
- Taşıma kapasitesi; arka mekanizma için maksimum 60kg, kapak mekanizması için maksimum 20kg dir.
- Menteşeli kapaklı tezgahaltı ya da üst dolaplarda kullanılabilir..
- 2 farklı modülde sağ ve sol yöne kullanılır.
- Kapak açıldığında arka gövde öne gelir, sepet içine kolay erişim sağlanır.
- Sepetler istenilen aralıklı yerleştirilebilir.
- Taşıyıcı mekanizma ve gövde gri boyalı, sepetler krom kaplamalıdır.

- Ball bearing telescopic rails are used in the bottom and top mechanisms.
- Carrying Capacity is max. 60 kg for back mechanism, and max 20 kg for door mechanism.
- Available for hinged under-counter or top cabinets with door.
- Can be used to open right or left with 2 different modules.
- When the door is open, back mechanism comes to front, provides easy access to the baskets.
- Baskets used on body by installing with desired distances onto channels of the profile.
- Bottom, top and door mechanisms are painted grey, baskets are chrome plated.

### RENK SEÇENEKLERİ

KROM  
KOD XXXXX

ANTRASİT  
KOD XXXXX-A

Bergama ikiz kiler / Bergamon twince pantry

Ürün Kodu / Product Code	Tip / Type	Ölçüler / Size GxDxY / WxDxH (mm)	Modül / Modul (mm)	Hacim / Volume (m3)	Ağırlık / Weight (kg)	Fiyat / Price (₺)
10105	125'lik	500 x 500 x 1250 - 1400	60	0,24	20,00	910
10205	125'lik	350 x 500 x 1250 - 1400	45	0,24	17,80	855
10116	170'lik	500 x 500 x 1700 - 1850	60	0,30	30,00	1150
10114	170'lik	350 x 500 x 1700 - 1850	45	0,30	25,00	1070

# Kör köşe grubu / Secret corner group



- Mutfaklarınızdaki köşe bölgeleri değerlendirmek içindir.
- Menteşeli kapak ile kullanıma uygundur.
- Taşıma kapasitesi, her bir sepet için 20kg' dir.
- Taşıyıcı boru, dolap yüksekliğine uygun ayarlanabilir.
- Sepetler birbirinden bağımsızdır çıkarılabilir.
- Sepet tabanları 18mm MDFLAM' dir.
- Sepet çevresi krom kaplama görünümlüdür.
- Sepet çerçevesi krom kaplamadır.
- Mekanizmalar gri renkte, sepet tabanları beyaz renktedir.

- Can be used to reach corner regions in your kitchen.
- Available hinged door on the corner cabinets.
- Carrying capacity is 20 kg for each basket.
- Carrier pipe can be adjusted according to the cabinet height.
- Both baskets are independent to each other.
- Basket floors are made of 18mm MDF.
- Baskets are surrounded by material looks like chrome plated.
- Basket frames are chrome plated.
- Mechanisms are grey, basket floors are white.

KOD: 39193 / Sol

## RENK SEÇENEKLERİ

KROM  
KOD XXXXX

ANTRASİT  
KOD XXXXX-A

Ahşap tabanlı elips kör köşe grubu / Wooden secret corner group

Ürün Kodu / Product Code	Model / Model	Modül / Modul (mm)	Ölçüler / Size GxDxY / WxDxH (mm)	Hacim / Volume (m3)	Ağırlık / Weight (kg)	Fiyat / Price (₺)
39192 (frenli&Soft Close)	elips sağ / elips (right)	45	900 x 530 x 750	0,08	13,00	900
39193 (frenli&Soft Close)	elips sol / elips (left)	45	900 x 530 x 750	0,08	13,00	900
39392 (frenli&Soft Close) (ANTRASİT)	elips sağ / elips (right)	45	900 x 530 x 750	0,08	13,00	900
39393 (frenli&Soft Close) (ANTRASİT)	elips sol / elips (left)	45	900 x 530 x 750	0,08	13,00	900

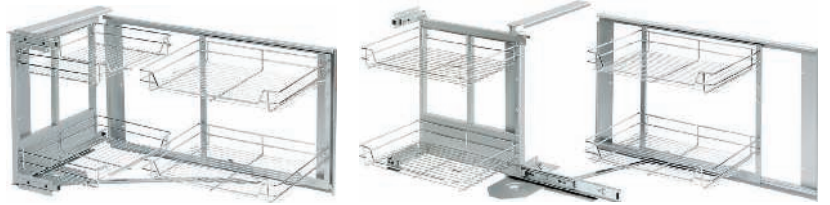
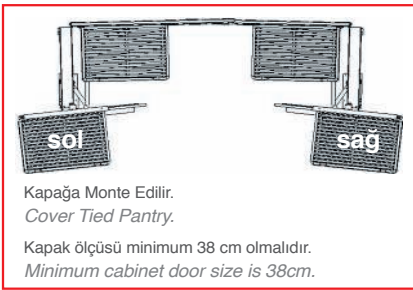

KOD: 39196

- Taşıma kapasitesi kapak mekanizması için 15 kg, arka mekanizma için 20 kg dir.
- Sepetler istenen aralıklarla asılarak kullanılır.
- Modül kapağının açılmasıyla ön taşıyıcıdaki sepetler dışarı çıkar, aynı anda arka taşıyıcı üzerindeki sepetler hareket ederek kolay ulaşılabilecek pozisyonu alır.

- Carrying capacity for door mechanism is 20 kg, for back mechanism 30 kg.
- Baskets can be installed with desired distances.
- When you open module door; baskets on the front carrier come out at the same time baskets on the behind carrier move and have easily accessible position.

## SOFT CLOSE (Frenli)

Kapağa monte kör köşe grubu / Secret corner group

Ürün Kodu / Product Code	Model / Model	Modül / Modul (mm)	Ölçüler / Size GxDxY / WxDxH (mm)	Hacim / Volume (m3)	Ağırlık / Weight (kg)	Fiyat / Price (₺)
39195	sağ / (right) frenli/soft close	40	860 x 530 x 600	0,15	20,20	1550
39196	sol / (left) frenli/soft close	40	860 x 530 x 600	0,15	20,20	1550

TSEK DOMODEK®

## Döner köşe grubu / Revolving corner group

- Menteşeli iki kapak ile kullanıma uygundur.
  - Taşıma kapasitesi, her sepet için 20 kg dır.
  - Alt sepet, taşıyıcı boru üzerinde tabanda, üst sepet ortada sabitlenerek kullanılır.
  - Taşıyıcı boru üzerinde 360° döndürülen sepetlerin her noktasına ulaşabilmek mümkündür.
  - Taşıyıcı boru, dolap yüksekliğine uygun ayarlanabilir.
  - Mekanizmada sepetler krom kaplamalı, taşıyıcı boru alüminyumdur.
- Available hinged two doors on the corner cabinets.
  - Carrying capacity is 20 kg for each of basket.
  - Bottom basket can be fixed on the carrier pipe at the base, upper basket can be fixed in the middle of the pipe.
  - Possible to reach any point of 3600 turning baskets on the carrier pipe.
  - Carrier pipe can be adjusted according to the cabinet height.
  - Baskets are chrome plated, carrier pipe is aluminum.

SOFT STOP  
FRENLİ

### RENK SEÇENEKLERİ

KROM  
KOD XXXXX

ANTRASİT  
KOD XXXXX-A



KOD: 24069



KOD: 23068



KOD: 22099

### Döner köşe grubu / Revolving corner group

Ürün Kodu / Product Code	Model / Model	Ölçüler / Size GxDxY / WxDxH (mm)	Hacim / Volume (m3)	Ağırlık / Weight (kg)	Fiyat / Price (₺)
24067	4/4 56	560 x 560 x 700 - 750	0,07	5,30	305
24069	4/4 72	720 x 720 x 700 - 750	0,11	6,30	340
24203	4/4 82	820 x 820 x 700 - 750	0,15	7,20	410
23066	3/4 56	560 x 560 x 700 - 750	0,07	5,00	300
23068	3/4 72	720 x 720 x 700 - 750	0,11	6,00	340
23201	3/4 82	820 x 820 x 700 - 750	0,15	7,00	410
22100	1/2 64 (borulu/with tube)	640 x 320 x 700 - 750	0,07	4,50	310
22099	1/2 74 (borulu/with tube)	740 x 370 x 700 - 750	0,07	5,20	320



## Ahşap tabanlı döner köşe grubu / Wooden based revolving corner group

- Mutfaklarınızdaki köşe bölgeleri değerlendirmek içindir.
- Menteşeli kapak ile kullanıma uygundur.
- Taşıma kapasitesi, her bir sepet için 20kg' dır.
- Taşıyıcı boru, dolap yüksekliğine uygun ayarlanabilir.
- Sepetler birbirinden bağımsızdır çıkarılabilir.
- Sepet tabanları 18mm MDFLAM' dır.
- Sepet çevresi krom kaplama görünümlüdür.
- Sepet çerçevesi krom kaplamadır.
- Mekanizmalar gri renkte, sepet tabanları beyaz renktedir.

- *Can be used to reach corner regions in your kitchen.*
- *Available hinged door on the corner cabinets.*
- *Carrying capacity is 20 kg for each basket.*
- *Carrier pipe can be adjusted according to the cabinet height.*
- *Both baskets are independent to each other.*
- *Basket floors are made of 18mm MDF.*
- *Baskets are surrounded by material looks like chrome plated.*
- *Basket frames are chrome plated.*
- *Mechanisms are grey, basket floors are white.*

### RENK SEÇENEKLERİ

KROM  
KOD XXXXX

ANTRASİT  
KOD XXXXX-A



KOD: 24962



KOD: 23962



KOD: 22951

### Ahşap Tabanlı Döner köşe grubu / Wooden based revolving corner group

Ürün Kodu / Product Code	Model / Model	Ölçüler / Size GxDxY / WxDxH (mm)	Hacim / Volume (m3)	Ağırlık / Weight (kg)	Fiyat / Price (₺)
24961	4/4 56	560 x 560 x 700 - 750	0,07	12,70	655
24962	4/4 72	720 x 720 x 700 - 750	0,12	14,90	710
23961	3/4 56	560 x 560 x 700 - 750	0,07	11,20	655
23962	3/4 72	720 x 720 x 700 - 750	0,12	13,20	710
22950	1/2 64	640 x 320 x 700 - 750	0,07	7,50	585
22951	1/2 74	740 x 320 x 700 - 750	0,07	9,00	600

## Yandan raylı şişelik-deterjanlık grubu / Bottle-detergent unit side tied



KOD: 30132

- Tezgah altında, menteşeli kapaklı dolaplarda ya da modül kapağına monte edilerek kullanılır.
- Genişliği dar modüllerde maksimum kullanım alanı sağlar.
- Taşıma kapasitesi 15 kg dır.
- İster bilyalı teleskobik rayla ister yavaş ve sessiz kapanma sağlayan soft close teleskobik rayla kullanılabilir.
- Modülün sağ veya sol paneline monte edilebilir.
- Sepet yüzeyleri krom kaplamadır.



KOD: 31133

- Available under-counter hinged cabinets with door or mounted module covers.
- Narrow width of the module provides the maximum use of space.
- Carrying capacity 15 kg.
- Can be used with ball bearing telescopic rails or soft close telescopic rails which provides silent and smooth closing.
- Baskets are chrome plated.



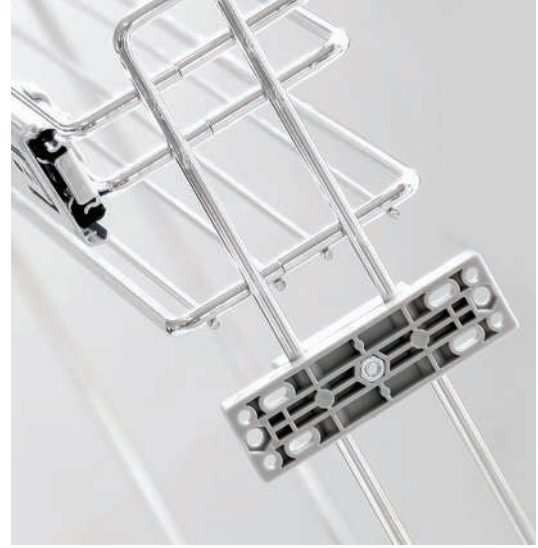

KOD:31133



## RENK SEÇENEKLERİ

KROM  
KOD XXXXX

ANTRASİT  
KOD XXXXX-A

Yandan raylı şişelik-deterjanlık grubu / Bottle-detergent unit side tied

Ürün Kodu / Product Code	Tip / Type	Ölçüler / Size GxDxY / WxDxH (mm)	Modül / Modul (mm)	Hacim / Volume (m3)	Koli içi Ad. / Volume (m3)	Ağırlık / Weight (kg)	Fiyat / Price (₺)
30132	Teleskopik Telescopic	Şişelik / bottle holder	15	0,03	5	4,20	210
31133		Deterjanlık / detergent place	20	0,04	4	4,50	215
31135			25	0,06	1	4,80	220
32134		Dar-geniş / tight-wide	30	0,06	1	5,20	230
32504		Geniş-geniş / wide-wide	30	0,06	1	5,50	230
30111	Frenli Soft close	Şişelik / bottle holder	15	0,03	5	4,20	240
30112		Deterjanlık / detergent place	20	0,04	4	4,50	275
30115			25	0,06	1	4,80	285
30113		Frenli / Soft close - Dar-geniş / tight-wide	30	0,06	1	5,20	300
30114		Frenli / Soft close - Geniş-geniş / wide-wide	30	0,06	1	5,50	300
31232	Teleskopik Telescopic	Ekonomik / Economic	15	0,04	5	2,60	195
31234		Ekonomik / Economic	20	0,05	4	2,90	198
31235		Ekonomik / Economic	25	0,05	1	3,10	200
31236		Ekonomik / Economic	30	0,06	1	3,20	205

TSEK

DOMODEK®



## Smart slide deterjanlık grubu / Smart slide detergent unit

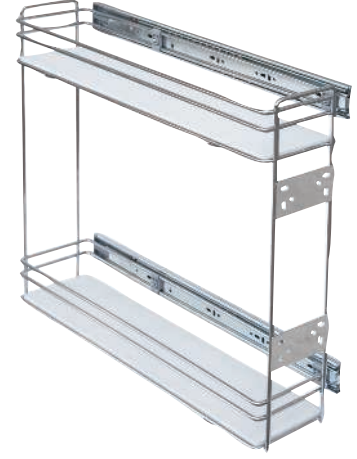

### SOFT CLOSE (Frenli)

Tandem Ray & Tandem Slides

- Tezgah altında, menteşeli kapaklı dolaplarda ya da modül kapağına monte edilerek kullanılır.
- Genişliği dar modüllerde maksimum kullanım alanı sağlar.
- Taşıma kapasitesi 15 kg'dır.
- Smart slide teleskobik raylar kullanılmıştır.
- Modülün sağ veya sol paneline monte edilebilir.
- Sepet yüzeyleri krom kaplamadır.

- Available under-counter hinged cabinets with door or mounted module covers.
- Narrow width of the module provides the maximum use of space.
- Carrying capacity 15 kg.
- Smart slide telescopic rails are used.
- Baskets are chrome plated.

### RENK SEÇENEKLERİ

KROM  
KOD XXXXX

ANTRASİT  
KOD XXXXX-A

Tandem raylı frenli deterjanlık grubu / Tandem soft close detergent unit group

Ürün Kodu / Product Code	Tip / Type	Ölçüler / Size GxDxY / WxDxH (mm)	Modül / Modul (mm)	Hacim / Volume (m3)	Ağırlık / Weight (kg)	Fiyat / Price (₺)
31121	çift açılım frenli / full ex.soft close	108 x 500 x 470	150	0,04	4,80	375
31122	çift açılım frenli / full ex.soft close	136 x 500 x 470	200	0,05	5,00	380
31123	çift açılım frenli / full ex.soft close	192 x 500 x 470	250	0,06	5,40	395
31124	çift açılım frenli / full ex.soft close	256 x 500 x 470	300	0,07	5,70	410
31127	tek açılım frenli / single ex.soft close	106 x 500 x 470	150	0,04	4,20	300
31128	tek açılım frenli / single ex.soft close	136 x 500 x 470	200	0,05	4,40	315
31129	tek açılım frenli / single ex.soft close	192 x 500 x 470	250	0,06	4,80	320
31130	tek açılım frenli / single ex.soft close	256 x 500 x 470	300	0,07	5,10	330

Ahşap tabanlı frenli deterjanlık grubu / Wooden based soft close detergent unit group

Ahşap tabanlı teleskobik raylı deterjanlık grubu / Wooden based telescopic rails detergent unit

36121	frenli / soft close	116 x 515 x 475	150	0,04	4,60	285
36122	frenli / soft close	140 x 515 x 475	200	0,05	5,00	300
36123	frenli / soft close	206 x 515 x 475	300	0,06	5,50	315

## Çekmece grubu / Drawer group

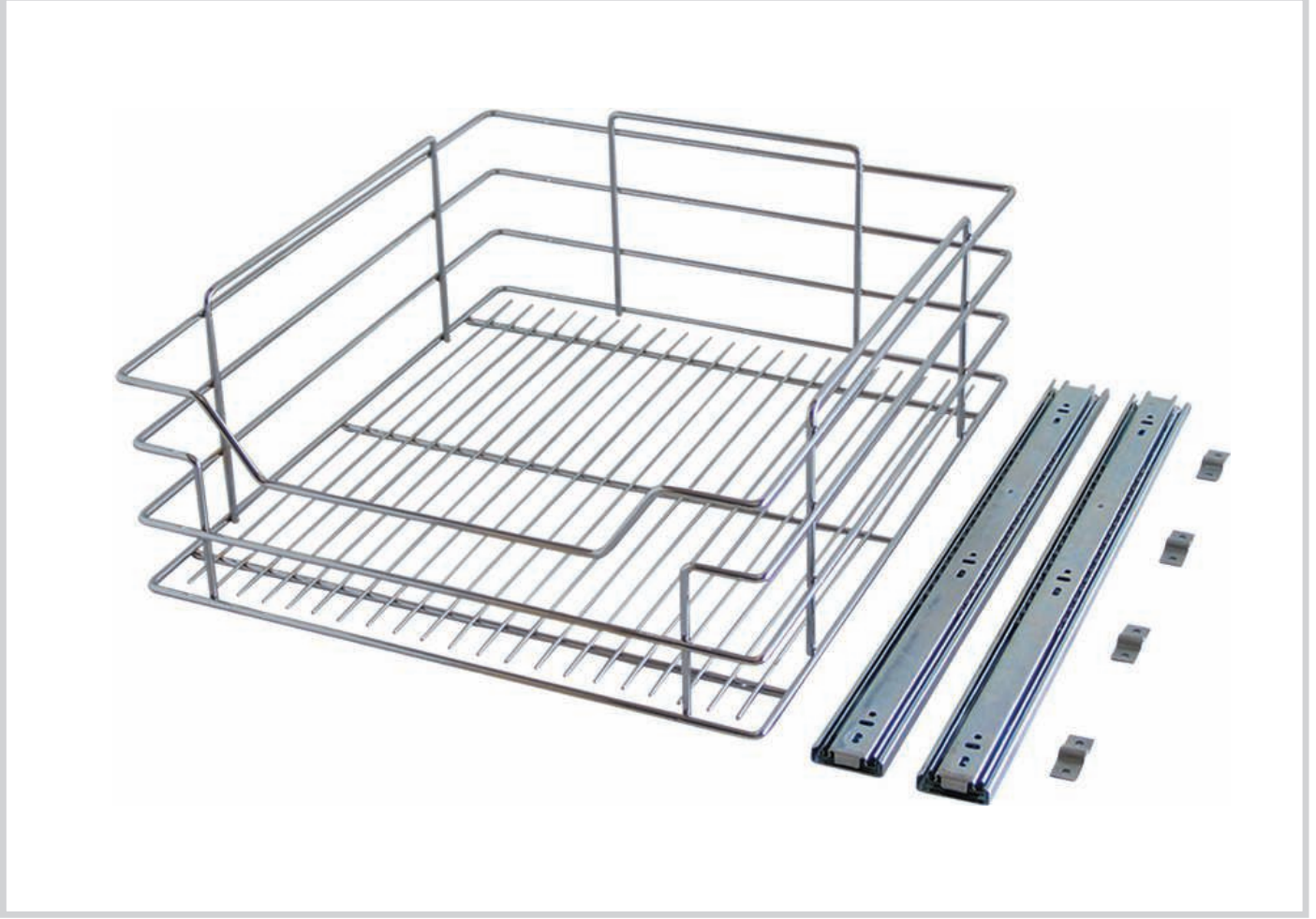

KOD: 63262

- Carrying capacity 15 kg.
- Can be used with ball bearing telescopic rails or soft close telescopic rails which provides silent and smooth closing.
- Baskets with 9 different module sizes are chrome plated.

### RENK SEÇENEKLERİ

KROM  
KOD XXXXX

ANTRASİT  
KOD XXXXX-A

#### Teleskopik raylı derin çekmece grubu / Telescopic deep drawer group

Ürün Kodu / Product Code	Tip / Type	Ölçüler / Size GxDxY / WxDxH (mm)	Modül / Modul (mm)	Hacim / Volume (m3)	Ağırlık / Weight (kg)	Fiyat / Price (₺)
63260	teleskopik / telescopic	300 x 500 x 180	35	0,04	4,70	205
63261	teleskopik / telescopic	350 x 500 x 180	40	0,04	5,00	206
63262	teleskopik / telescopic	400 x 500 x 180	45	0,04	5,30	207
63263	teleskopik / telescopic	450 x 500 x 180	50	0,05	5,60	208
63264	teleskopik / telescopic	500 x 500 x 180	55	0,06	5,90	210
63265	teleskopik / telescopic	550 x 500 x 180	60	0,06	6,20	220
63285	frenli / soft close	300 x 500 x 180	35	0,04	4,70	255
63286	frenli / soft close	350 x 500 x 180	40	0,04	5,00	256
63287	frenli / soft close	400 x 500 x 180	45	0,04	5,30	257
63288	frenli / soft close	450 x 500 x 180	50	0,05	5,60	258
63289	frenli / soft close	500 x 500 x 180	55	0,06	5,90	265
63290	frenli / soft close	550 x 500 x 180	60	0,06	6,20	275

TSEK

DOMODEK®

## Tandem raylı çekmece grubu / Tandem slides drawer group



### RENK SEÇENEKLERİ

KROM  
KOD XXXXX

ANTRASİT  
KOD XXXXX-A

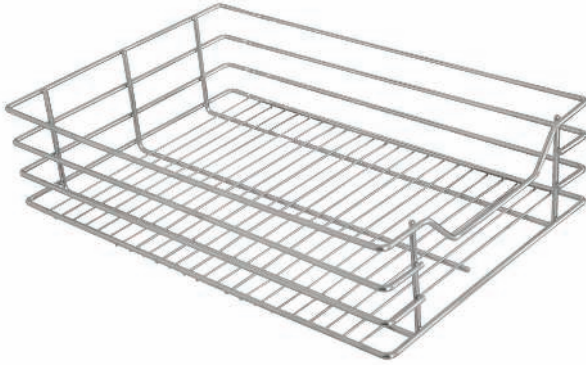

- Tezgah altında, menteşeli kapaklı dolaplarda ya da modül kapağına monte edilerek kullanılır.
- Taşıma kapasitesi 15 kg dır.
- Standart, tek açılım ya da çift açılım tandem raylarla kullanılabilir.
- 6 farklı modül genişliğine uygun sepetler krom kaplamalıdır.

- Available under-counter hinged cabinets with door or mounted module covers.
- Carrying capacity 15 kg.
- Can be used with standart, single-extension soft close or full-extension soft close tandem rails.
- Baskets with 6 different module sizes are chrome plated.

### Tandem raylı çekmece grubu / Tandem drawer group

Ürün Kodu / Product Code	Tip / Type	Ölçüler / Size GxDxY / WxDxH (mm)	Modül / Modul (mm)	Hacim / Volume (m3)	Ağırlık / Weight (kg)	Fiyat / Price (₺)
64403	çift aç.frenli / full extension.soft close	300 x 500 x 150	35	0,04	5,00	360
64404	çift aç.frenli / full extension.soft close	350 x 500 x 150	40	0,04	5,30	365
64405	çift aç.frenli / full extension.soft close	400 x 500 x 150	45	0,04	5,60	370
64406	çift aç.frenli / full extension.soft close	450 x 500 x 150	50	0,05	5,90	375
64407	çift aç.frenli / full extension.soft close	500 x 500 x 150	55	0,06	6,20	380
64408	çift aç.frenli / full extension.soft close	550 x 500 x 150	60	0,06	6,50	390
64423	tek aç.frenli / single extension.soft close	300 x 500 x 150	35	0,04	5,00	290
64424	tek aç.frenli / single extension.soft close	350 x 500 x 150	40	0,04	5,30	295
64425	tek aç.frenli / single extension.soft close	400 x 500 x 150	45	0,04	5,60	300
64426	tek aç.frenli / single extension.soft close	450 x 500 x 150	50	0,05	5,90	305
64427	tek aç.frenli / single extension.soft close	500 x 500 x 150	55	0,06	6,20	310
64428	tek aç.frenli / single extension.soft close	550 x 500 x 150	60	0,06	6,50	320



## Eviye altı çekmece grubu / Sink drawer group



- Tezgah altında, menteşeli kapaklı dolaplarda ya da modül kapağına monte edilerek kullanılır.
- Taşıma kapasitesi 15 kg dır.
- Standart, tek açılım ya da çift açılım tandem raylarla kullanılabilir.
- 2 farklı modül genişliğine uygun sepetler krom kaplamalıdır.

- Available under-counter hinged cabinets with door or mounted module covers.
- Carrying capacity 15 kg.
- Can be used with standart, single-extension soft close or full-extension soft close tandem rails.
- Baskets with 2 different module sizes are chrome plated.

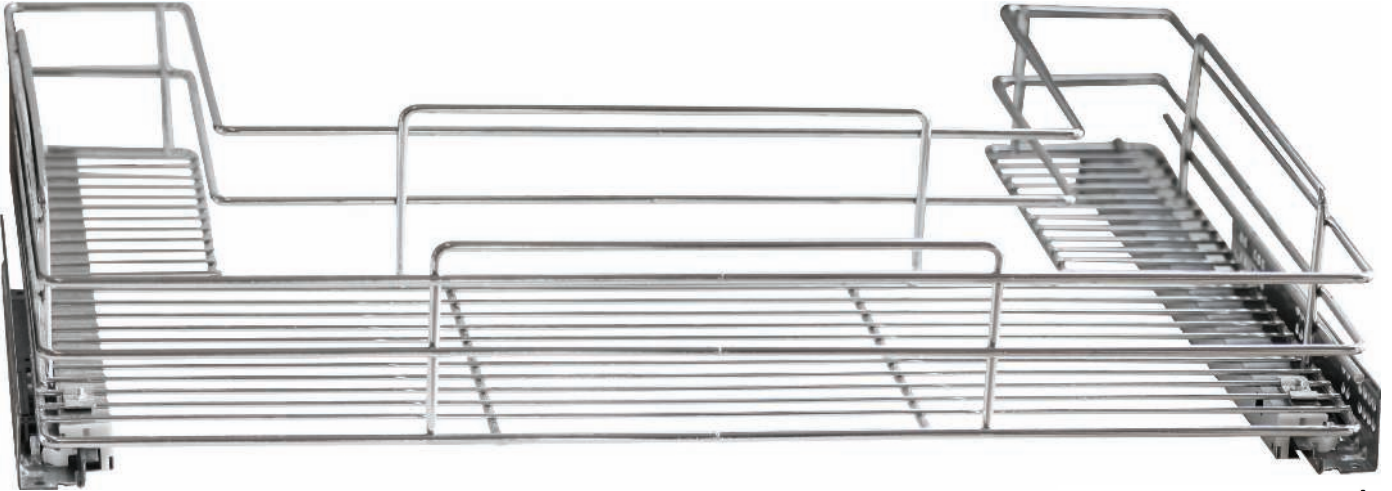

### RENK SEÇENEKLERİ

KROM  
KOD XXXXX

ANTRASİT  
KOD XXXXX-A

Tandem raylı eviye altı çekmece / Tandem sink drawer

Ürün Kodu / Product Code	Tip / Type	Ölçüler / Size GxDxY / WxDxH (mm)	Modül / Modul (mm)	Hacim / Volume (m3)	Ağırlık / Weight (kg)	Fiyat / Price (₺)
61001	Çift açılım frenli / full extension soft close	764 x 500 x 110	80	0,10	5,00	475
61005	Çift açılım frenli / full extension soft close	864 x 500 x 110	90	0,12	6,00	500

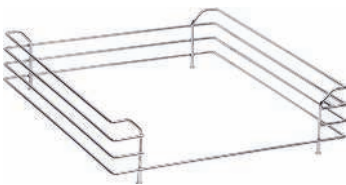

KOD: 68205

Çekmece çerçevesi / Drawer frame

Ürün Kodu / Product Code	Ölçüler / Size GxDxY / WxDxH (mm)	Modül / Modul (mm)	Hacim / Volume (m3)	Ağırlık / Weight (kg)	Fiyat / Price (₺)
68203	280 x 500 x 120	35	0,01	1,20	115
68204	330 x 500 x 120	40	0,01	1,40	116
68205	380 x 500 x 120	45	0,01	1,60	117
68206	430 x 500 x 120	50	0,02	1,80	118
68207	480 x 500 x 120	55	0,02	2,00	120

TSEK

DOMODEK®

# Mutfak aksesuarları grubu / Kitchen accessories group



- Tezgahüstü grubundaki ürünlerin montajında kullanılırlar.
- Borular tapalı ve krom kaplamadır.
- Used for the assembly of over-counter units.
- Pipes have caps and are chrome plated.

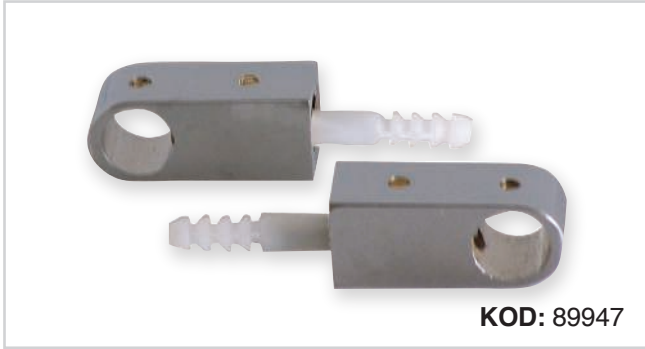

KOD: 89947



KOD: 89948



KOD: 89949



KOD: 88910

## Set arası askı grubu / Midway set hang group

Ürün Kodu / Product Code	Ürün Adı / Product Name	Koli içi ad. / In box	Hacim / Volume (m3)	Ağırlık / Weight (kg)	Fiyat / Price (₺)
89149	tapalı boru 40 cm / pipe with tube plug 40 cm	10	0,01	0,15	32
89150	tapalı boru 50 cm / pipe with tube plug 50 cm	10	0,01	0,19	33
89151	tapalı boru 60 cm / pipe with tube plug 60 cm	10	0,01	0,22	34
89152	tapalı boru 80 cm / pipe with tube plug 80 cm	10	0,01	0,29	36
89153	tapalı boru 100 cm / pipe with tube plug 100 cm	10	0,01	0,36	41
89154	tapalı boru 120 cm / pipe with tube plug 120 cm	10	0,01	0,44	45
88910	50 cm boru bağlantı kanca set / 50 cm pipe connector hook set		0,01	0,36	80
89947	bağlantı takım / connector set		0,01	0,01	40
89948	tekli kanca / single hook		0,01	0,01	4
89949	ikili kanca / double hook		0,01	0,01	10

## RENK SEÇENEKLERİ

KROM  
KOD XXXXX

ANTRASİT  
KOD XXXXX-A



KOD: 88801



KOD: 88802



KOD: 88803



KOD: 80801



KOD: 88802



KOD: 88803

- Ürünler krom kaplamadır.
- Plastik tapalar mevcuttur.
- Set olan ürünlerimize boru ve bağlantılar dahildir.

- Products are chrome plated.
- Plastic caps are available.
- Pipe and connectors are included in sets.

## RENK SEÇENEKLERİ

KROM  
KOD XXXXX

ANTRASİT  
KOD XXXXX-A

### Havluluk - folyoluk / Towel - foil paper

Ürün Kodu / Product Code	Tip / Type	Ölçüler / Size GxDxY / WxDxH (mm)	Koli içi ad. / In box	Hacim / Volume (m3)	Ağırlık / Weight (kg)	Fiyat / Price (₺)
80801	üçlü / triple	320 x 150 x 370	10	0,22	1,50	135
80802	ikili / double	320 x 150 x 300	10	0,22	1,30	110
80803	tekli / single	320 x 150 x 260	10	0,22	1,20	90
88801	üçlü / triple (SET)	320 x 150 x 370	8	0,22	2,00	195
88802	ikili / double (SET)	320 x 150 x 300	8	0,22	1,80	170
88803	tekli / single (SET)	320 x 150 x 260	8	0,22	1,70	165



KOD: 88804



KOD: 88808



KOD: 88809



KOD: 81804

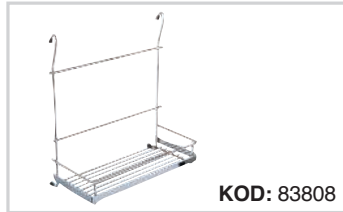

KOD: 83808



KOD: 83809

- Ürünler krom kaplamadır.
- Plastik tapalar mevcuttur.
- Set olan ürünlerimize boru ve bağlantılar dahildir.

- Products are chrome plated.
- Plastic caps are available.
- Pipe and connectors are included in sets.

## RENK SEÇENEKLERİ

KROM  
KOD XXXXX

ANTRASİT  
KOD XXXXX-A

### Baharatlık / Spice holder

Ürün Kodu / Product Code	Tip / Type	Ölçüler / Size GxDxY / WxDxH (mm)	Koli içi ad. / In box	Hacim / Volume (m3)	Ağırlık / Weight (kg)	Fiyat / Price (₺)
81804	klasik / classic	320 x 170 x 330	10	0,22	1,50	135
83808	uzun / long	325 x 170 x 370	10	0,22	1,30	110
83809	kısa / short	330 x 170 x 290	10	0,22	1,20	90
88804	klasik / classic (SET)	320 x 170 x 330	8	0,22	2,00	195
88808	uzun / long (SET)	325 x 170 x 370	8	0,22	1,80	170
88809	kısa / short (SET)	330 x 170 x 290	8	0,22	1,70	165





KOD: 88001

## RENK SEÇENEKLERİ

KROM  
KOD XXXXX

ANTRASİT  
KOD XXXXX-A



KOD: 88001

- 3lü havluluk, klasik baharatlık, 80cm boru, 5 adet kanca ve bağlantılı elamanlarından oluşan bir settir.
- Tüm ürünler krom kaplamadır.
- Plastik tapalar mevcuttur.

- This set includes a triple towel rack, a spice holder, a 80cm pipe, 5 hooks and connectors.
- All products in this set are chrome plated.
- Plastic caps are available.

### Askılı ürünler / Hanged products

Ürün Kodu / Product Code	Tip / Type	Ölçüler / Size GxDxY / WxDxH (mm)	Koli içi ad. / In box	Hacim / Volume (m3)	Ağırlık / Weight (kg)	Fiyat / Price (₺)
88001	Set 1 / Set 1	750 x 185 x 375	4	0,20	4,60	320



KOD: 86074



KOD: 86073



KOD: 86072

## RENK SEÇENEKLERİ

KROM  
KOD XXXXX

ANTRASİT  
KOD XXXXX-A

- Yıkamış bulaşıklarınızı organize etmekte yardımcı olur.
- Plastik tepsi ve kaşıklik mevcuttur.
- Tüm ürünler krom kaplamadır.

- Helps to organize your washed dishes.
- Plastic plate and spoon holder are available
- All products are chrome plated.

### Tabaklık grubu / Dish holder

Ürün Kodu / Product Code	Tip / Type	Ölçüler / Size GxDxY / WxDxH (mm)	Koli içi ad. / In box	Hacim / Volume (m3)	Ağırlık / Weight (kg)	Fiyat / Price (₺)
86074	tekli krom tabaklık / dish holder single	360 x 440 x 130	6	0,22	1,85	135
86073	iki katlı krom tabaklık / dish holder double	360 x 440 x 240	4	0,22	2,70	165
86072	uzun krom tabaklık / dish holder long	370 x 785 x 250	4	0,22	3,35	185

TSEK

DOMODEK®

## Dolap içi tabaklık-bardaklık / Plate -glass shelf

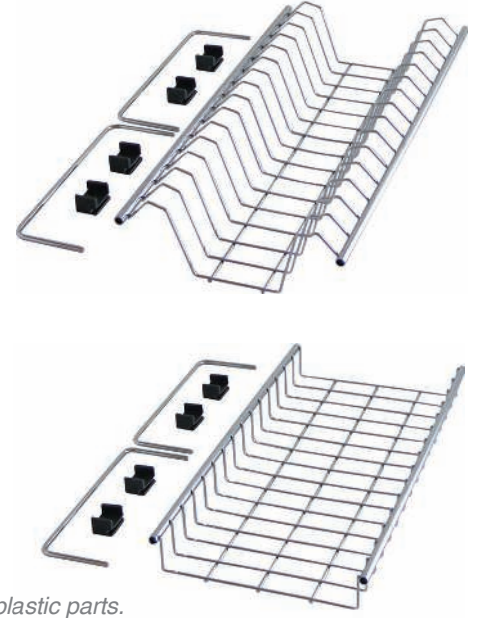

- Plastik aparatlarla dolap yanlarına bağlanır. • Fixed to the sides of the cabinet with plastic parts.
- Sabit ya da ayarlanabilir özelliklidir. • Can be fixed or adjustable.
- Sepetler krom kaplamadır. • Baskets are chrome plated.

### RENK SEÇENEKLERİ

KROM  
KOD XXXXX

ANTRASİT  
KOD XXXXX-A

#### Ayarlanabilir tabaklık-bardaklık / Adjustable plate-glass holder

Ürün Kodu / Product Code	Tip / Type	Modül / Modul	Ölçüler / Size GxDxY / WxDxH (mm)	Koli içi ad. / In box	Hacim / Volume (m3)	Ağırlık / Weight (kg)	Fiyat / Price (₺)
45010	tabaklık / dish holder	55-60	500 x 250 x 80	10	0,07	0,85	100
45011	tabaklık / dish holder	65-70	600 x 250 x 80	10	0,09	1,00	101
45012	tabaklık / dish holder	75-80	700 x 250 x 80	10	0,09	1,15	102
45013	tabaklık / dish holder	85-90	800 x 250 x 80	10	0,12	1,30	103
45014	tabaklık / dish holder	95-100	900 x 250 x 80	10	0,12	1,45	104
40010	bardaklık / glass holder	55-60	500 x 250 x 80	10	0,07	0,80	100
40011	bardaklık / glass holder	65-70	600 x 250 x 80	10	0,09	0,95	101
40012	bardaklık / glass holder	75-80	700 x 250 x 80	10	0,09	1,10	102
40013	bardaklık / glass holder	85-90	800 x 250 x 80	10	0,12	1,25	103
40014	bardaklık / glass holder	95-100	900 x 250 x 80	10	0,12	1,40	104



#### Damlalıklı tabaklık-bardaklık / Dish&bottle with dropper

Ürün Kodu / Product Code	Tip / Type	Modül / Modul	Ölçüler / Size GxDxY / WxDxH (mm)	Koli içi ad. / In box	Hacim / Volume (m3)	Ağırlık / Weight (kg)	Fiyat / Price (₺)
40141	bardaklık / glass holder	60	564 x 250 x 80	10	0,07	1,00	125
45141	tabaklık / dish holder	60	564 x 250 x 80	10	0,09	1,15	125
40143	bardaklık / glass holder	80	764 x 250 x 80	10	0,09	1,30	135
45143	tabaklık / dish holder	80	764 x 250 x 80	10	0,12	1,45	135
42141	tabaklık-bardaklık (SET) / dish and glass holder (SET)	60	564 x 250 x 80	1	0,02	2,15	225
44141	tabaklık-bardaklık (SET) / dish and glass holder (SET)	80	764 x 250 x 80	1	0,02	2,75	240





- Mutfaklarınıza ya da salonlarınıza dekoratif çözüm sunar.
- 4 farklı boru seçeneğiyle istediğiniz yerde kullanabilirsiniz.
- 5 farklı sepet seçeneği mevcuttur.
- Metal flanşlar dahildir.
- Sepetler, boru ve metal flanşlar krom kaplamadır.

- Provides decorative solutions to your kitchens or living rooms.
- 4 different pipe lengths are available.
- 5 different baskets are available.
- Metal flanges are included.
- Baskets, pipes and metal flanges are chrome plated



KOD: 53310



KOD: 53318



KOD: 53312



KOD: 53320



KOD: 53316



KOD: 533344

## RENK SEÇENEKLERİ

KROM  
KOD XXXXX

ANTRASİT  
KOD XXXXX-A

KOD: 53344



boru ile birlikte verilir. comes with the pipe.

### Bar grubu / Bar group

Ürün Kodu / Product Code	Tip / Type	Ölçüler / Size GxDxY / WxDxH (mm)	Koli içi ad. / In box	Hacim / Volume (m3)	Ağırlık / Weight (kg)	Fiyat / Price (₺)
53302	barborusu / bar pipe	1000 x (Ø) 42,5	1	0,01	4,30	225
53304	barborusu / bar pipe	1300 x (Ø) 42,5	1	0,01	4,60	250
53305	barborusu / bar pipe	1500 x (Ø) 42,5	1	0,02	5,00	340
53306	barborusu / bar pipe	2100 x (Ø) 42,5	1	0,02	5,40	370
53344	duvar bağlantısı / wall connector		5	0,08	0,80	155
53310	pleksi taban / plexy round	90x (Ø) 365	5	0,08	2,10	195
53312	ağşap taban / wooden round	70x (Ø) 365	5	0,08	2,10	195
53316	hasır döner taban / wire round	55x (Ø) 365	5	0,08	1,40	205
53318	hasır üçgen taban / wire triangle round	55x (Ø) 365	5	0,08	1,20	205
53320	kadehlik / drinking glass holder	70x (Ø) 365	5	0,08	1,30	205



## Bar grubu / Bar group



### RENK SEÇENEKLERİ

KROM  
KOD XXXXX

ANTRASİT  
KOD XXXXX-A

#### Bar grubu / Bar group

Ürün Kodu / Product Code	Tip / Type	Ölçüler / Size GxDxY / WxDxH (mm)	Koli içi ad. / In box	Hacim / Volume (m3)	Ağırlık / Weight (kg)	Fiyat / Price (₺)
53450	bar standı / bar stand	720 x 350 x 350	1	0,07	5,40	445

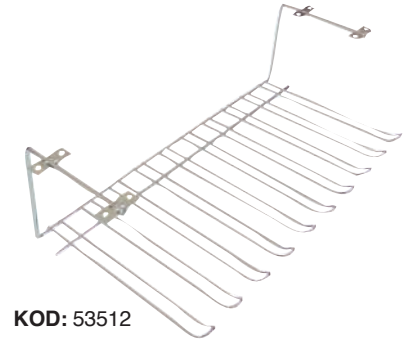

KOD: 53512

### RENK SEÇENEKLERİ

KROM  
KOD XXXXX

ANTRASİT  
KOD XXXXX-A

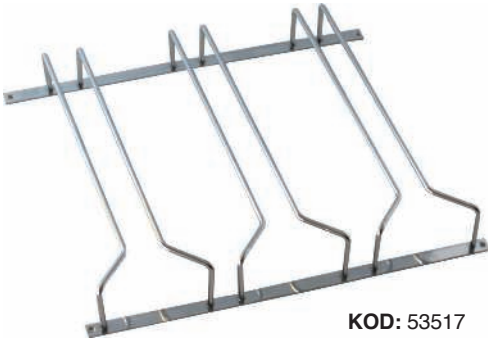

KOD: 53517

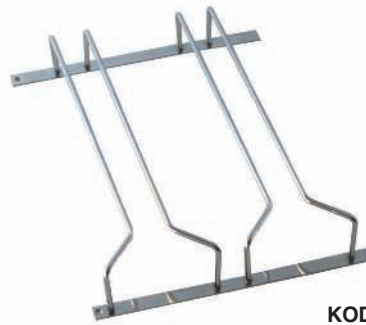

KOD: 53516



KOD: 53515

#### Bar grubu / Bar group

Ürün Kodu / Product Code	Tip / Type	Ölçüler / Size GxDxY / WxDxH (mm)	Koli içi ad. / In box	Hacim / Volume (m3)	Ağırlık / Weight (kg)	Fiyat / Price (₺)
53515	lamalı kadehlik tekli / single sheet	225 x 357 x 60	30	0,12	0,25	65
53516	lamalı kadehlik ikili / double sheet	265 x 357 x 60	20	0,12	0,55	90
53517	lamalı kadehlik üçlü / triple sheet	395 x 357 x 60	10	0,12	0,85	115
53512	sabit kadehlik / fixed sheet	460 x 240 x 150	20	0,12	0,90	125

TSEK

DOMODEK®

# Gardrop grubu / Wardrop group



Pantolon askısı grubu / Panth holder

## Yandan bağlantılı pantolon askısı grubu Side Tied Tis Panth Holder

Modül / Modul	Ölçüler / Size GxDxY / WxDxH (mm)	Koli içi ad. / In box	Hacim / Volume (m3)	Ürün Kodu / Product Code	Ağırlık / Weight (kg)	Fiyat / Price (₺)
30-35	260 x 500 x 30	5	0,03	75116	1,95	180
35-40	310 x 500 x 30	5	0,04	75117	2,05	181
40-45	360 x 500 x 30	5	0,04	75118	2,15	182
45-50	410 x 500 x 30	5	0,05	75119	2,25	183
50-55	460 x 500 x 30	5	0,05	75120	2,35	184
55-60	510 x 500 x 30	5	0,07	75121	2,45	185
60-65	560 x 500 x 30	5	0,07	75122	2,55	186
65-70	610 x 500 x 30	5	0,07	75123	2,65	187
70-75	660 x 500 x 30	5	0,09	75124	2,75	188
75-80	710 x 500 x 30	5	0,09	75125	2,85	189
80-85	760 x 500 x 30	5	0,09	75126	2,95	190
85-90	810 x 500 x 30	5	0,10	75127	3,05	191
90-95	860 x 500 x 30	5	0,10	75128	3,15	192
95-100	910 x 500 x 30	5	0,10	75129	3,25	193
100-105	960 x 500 x 30	5	0,10	75130	3,35	194

## RENK SEÇENEKLERİ

KROM  
KOD XXXXX

ANTRASİT  
KOD XXXXX-A



# Banyo aksesuarları grubu / Bath accessories

## RENK SEÇENEKLERİ

KROM  
KOD XXXXX

ANTRASİT  
KOD XXXXX-A



Askılı çamaşır sepeti / Hooked laundry basket

Ürün Kodu / Product Code	Modül / Modul	Ölçüler / Size GxDxY / WxDxH (mm)	Koli içi ad. / In box	Hacim / Volume (m3)	Ağırlık / Weight (kg)	Fiyat / Price (₺)
79377	300	230 x 315 x 500	4	0,177	2,45	120
79378	350	280 x 315 x 500	4	0,212	2,85	135
79379	400	330 x 315 x 500	4	0,247	3,10	140
79380	450	380 x 315 x 500	4	0,281	3,35	145
79381	500	430 x 315 x 500	4	0,316	3,65	150
79382	550	480 x 315 x 500	4	0,342	3,75	155
79383	600	530 x 315 x 500	4	0,368	3,85	170

## RENK SEÇENEKLERİ

KROM  
KOD XXXXX

ANTRASİT  
KOD XXXXX-A

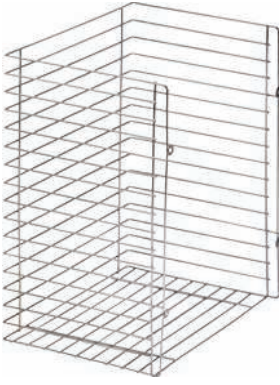

Kapağa monte çamaşır sepeti / Laundry basket

Ürün Kodu / Product Code	Tip / Type	Modül / Modul	Ölçüler / Size GxDxY / WxDxH (mm)	Koli içi ad. / In box	Hacim / Volume (m3)	Ağırlık / Weight (kg)	Fiyat / Price (₺)
79080		300	230 x 250 x 500	8	0,12	0,80	105
79081		350	280 x 250 x 500	8	0,12	0,90	106
79082		400	330 x 250 x 500	8	0,12	1,30	107
79083		450	380 x 250 x 500	8	0,12	1,50	110
79084		500	430 x 250 x 500	8	0,12	1,50	120
79085		550	480 x 250 x 500	8	0,15	1,70	135
79086		600	530 x 250 x 500	8	0,15	1,90	145
79087		650	580 x 250 x 500	8	0,15	2,10	170

## RENK SEÇENEKLERİ

KROM  
KOD XXXXX

ANTRASİT  
KOD XXXXX-A



Banyo köşe / Bath corner

Ürün Kodu / Product Code	Tip / Type	Ölçüler / Size GxDxY / WxDxH (mm)	Koli içi ad. / In box	Hacim / Volume (m3)	Ağırlık / Weight (kg)	Fiyat / Price (₺)
79410	ikili / single	310 x 230 x 315	20	0,22	1,10	75
79412	üçle / triple	310 x 230 x 525	16	0,22	1,40	90

TSEK

DOMODEK®



# Sertifikalarımız / Our Certifications



**СИСТЕМА СЕРТИФИКАЦИИ ГОСТ Р**  
ФЕДЕРАЛЬНОЕ АГЕНТСТВО ПО ТЕХНИЧЕСКОМУ РЕГУЛИРОВАНИЮ И МЕТРОЛОГИИ

**СЕРТИФИКАТ СООТВЕТСТВИЯ**

№ РОСС TR.ДЕ01.Н38643  
Срок действия с 24.06.2013г. по 23.06.2016г.  
№ 0651535

**ОРГАН ПО СЕРТИФИКАЦИИ**  
РОСС DE.0001.11ДЕ01  
ДИН ГОСТ ТЮФ БЕРЛИН-БРАНДЕНБУРГ Общество по сертификации в Европе,  
Будапештер Штр. 31, 10787 Берлин, Германия, Тел: +49/302601 2110, Факс: +49/302601 1210, service@din-gost.de

**ПРОДУКЦИЯ**  
изделия кухонные и ванные из черных металлов (Сталь или Алюминий), хромированные: полочки, стеллажи, сетки, держатели, полки-карусели, бутылочницы, корзины, крючки, подставки, вешалки  
серийный выпуск  
СООТВЕТСТВУЕТ ТРЕБОВАНИЯМ НОРМАТИВНОГО ДОКУМЕНТА  
ГОСТ Р 51687-2000, код ОК 005 (ОКП): 14 8000

**ИЗГОТОВИТЕЛЬ**  
DOMODEK NURETT'YN SEVG'YN  
KOSBY ANKARA ASFALTI 26.KM KEMALPAŞA / İZMİR

**СЕРТИФИКАТ ВЫДАН**  
DOMODEK NURETT'YN SEVG'YN  
KOSBY ANKARA ASFALTI 26.KM KEMALPAŞA / İZMİR

**НА ОСНОВАНИИ**  
сертификата № 0110-13 от 19.06.2013 г., выданного

**МІНІСТЕРСТВО ОХОРОНИ ЗДОРОВ'Я УКРАЇНИ**  
**ДЕРЖАВНА САНИТАРНО-ЕПІДЕМІОЛОГІЧНА СЛУЖБА**

**ЗАТВЕРДЖУЮ**

Міністерство охорони здоров'я України  
(назва установи)  
вул.Грушевського, 7, м.Київ, 01601  
(місцезнаходження)  
253-94-84, 559-29-88

Перший заступник головної державно-санітарної інспекції України  
О.П. Кравчук

**к державної санітарно-епідеміологічної експертизи**

24. 2013р. № 05.03.02-03/ 62298

тки, тримачі, полиці-каруселі, бутылочниця, корзини, гачки, релінги, тримачі, сталі, алюміній хромовані)  
(об'єкт експертизи)

(код за ДСТН, код за УКТНД експертизи)

**кухонь, ванні, оптово-роздрібна торгівля**  
(сфери застосування та реліації об'єкта експертизи)

**TIN SEVG'IN\*, Туреччина, KOSBI ANKARA ASFALTI 26.KM KEMALPAŞA / İZMİR**  
(назва виробника, адреса, місцезнаходження, телефон, факс, E-mail, WWW)

**TIN SEVG'IN\*, Туреччина, KOSBI ANKARA ASFALTI 26.KM KEMALPAŞA / İZMİR**  
(назва експертизи, адреса, місцезнаходження, телефон, факс, E-mail, WWW)

**до документів, що супроводжують вантаж**  
(назва протоколу на проведення об'єкта експертизи в Україні)

**відповідає встановленим медичним критеріям безпеки / показникам: стання не чинить шкідливого впливу на здоров'я людей.**  
(критерії безпеки / показники)

**при використанні / застосуванні, зберіганні, транспортуванні, утилізації, знищення**  
виробленої продукції необхідно дотримуватись вимог даного висновку, чинного (санітарних норм та правил, особливості умов використання, застосування, зберігання, транспортування, утилізації, знищення)

даного санітарно-епідеміологічної експертизи Полочки, стелажі, сітки, тримачі, полиці, корзини, гачки, релінги, тримачі, підставки, вешалки (сталь, алюміній хромовані), за умов відповідала вимогам діючого санітарного законодавства України і за умов його висновку може бути використаний в зазначеній сфері застосування.

**згідно рекомендацій виробника.**  
не, використання згідно з інструкцією виробника. Висновок не може бути використаний як якостей виробу або продукції.  
(інформація щодо етикетки, інструкції, правила тощо)

**з 12 липня 2015 р.**

підписання вимог цього висновку несе заявник.  
технології виготовлення, які можуть змінити властивості об'єкта експертизи або її вплив на здоров'я людей, сфери застосування, умов застосування об'єкта експертизи

**TSEK TÜRK STANDARDLARI ENSTİTÜSÜ**  
**KRİTERE UYGUNLUK BELGESİ**  
**TURKISH STANDARDS INSTITUTION**  
**CERTIFICATE OF CONFORMANCE TO CRITERIA**

Markanın Tanımı	Description of the Mark
<b>TSEK</b> veya / <b>TSEK</b>	
<b>BELGE NUMARASI</b> REFERENCE NUMBER OF LICENCE	079514-TSEK-01/01
<b>BELGENİN İLK VERİLİŞ TARİHİ</b> DATE OF FIRST ISSUE OF LICENCE	27.05.2008
<b>BELGENİN SON GEÇERLİLİK TARİHİ</b> LICENCE VALID UNTIL	27.05.2019
<b>BELGE SAHİBİ KURULUŞUN ADI</b> NAME OF THE LICENCE HOLDER	DOMODEK METAL PLASTİK MAKİNA SAN. VE TİC.LTD. ŞTİ
<b>BELGE SAHİBİ KURULUŞUN ADRESİ</b> ADDRESS OF THE LICENCE HOLDER	ANSIZCA SANAYİ SİTESİ SOKAK NO : 346/A ORGANİZE SANAYİ BÖLGESİ KEMALPAŞA - İZMİR İZMİR
<b>ÜRETİM YERİ ADI</b> NAME OF THE MANUFACTURING PLACE	DOMODEK METAL PLASTİK MAKİNA SAN. VE TİC.LTD. ŞTİ
<b>ÜRETİM YERİ ADRESİ</b> ADDRESS OF THE MANUFACTURING PLACE	ANSIZCA SANAYİ SİTESİ SOKAK NO : 346/A ORGANİZE SANAYİ BÖLGESİ KEMALPAŞA - İZMİR İZMİR
<b>TESCİLLİ TİCARİ MARKASI</b> REGISTERED TRADE MARK	DOMODEK
<b>İLGİLİ BELGELENDİRME KRİTERİ</b> RELATED TURKISH STANDARD	UBM-00-BK-000 / Kriteri Seçilmemiş Sözleşmeler için / 24.08.2010
<b>BELGE KAPSAMI</b> SCOPE OF LICENCE	MUTFAK DOLAP İÇİ RAF (KİLER) SİSTEMLERİ VE AKSESUARLARI DOLAP İÇİ VEYA ASMA SİSTEMLİ KROM KAPLI.

2016  
**AHMET NAMLI**  
İZMİR BELGELENDİRME MÜDÜRÜ

\*Bu belge, belgelendirilen ürünün üretim sürecinin enstitümüzün belgelendirip garanti altına aldığıdır.  
\*Bu belge bir diğer belgeyi iptal etmez. Herhangi bir değişiklikten önceki belgeler geçerli ve aynı zamanda.  
\*TSE CMBB BELGELENDİRME MÜDÜRLÜĞÜ Adres: Etiler Mah. Nispetiye (İZMİR) Tel: 0232 378 24 28(31) Faks: 0 232 448 42 30 \* Web: \* e-mail: \*  
\*TSE BELGELENDİRME MERKEZİ BAŞKANLIĞI Adres: Nispetiye Mah. No:112 08100 Bakırköy/İZMİR - Tel: 0 312 416 64 91 / 416 64 27, Faks: 0 312 416 66 17  
e-posta: tse@tse.org.tr, web : www.tse.org.tr

## Notlar / Notes

- Baskıda oluşacak tipografik hatalardan firmamız sorumlu tutulamaz.
- Hammade ile ilgili maliyet artışları fiyatlara yansıtılacaktır.
- Bu katalog içeriği ve görselleri, izin alınmaksızın çoğaltılamaz ve başka yerde kullanılamaz.

"Firmamız ürün tasarımlarında ve görsellerinde değişiklik yapma hakkını saklı tutar. Sevk edilen ürünlerde katalogdaki referans resimler değil, güncel tasarımlar göz önünde bulundurulur."

# DOMODEK®

İZMİR

**Metal mutfak aksesuarları kiler, banyo, gardrop ve bar sistemleri**  
*Metal kitchen accessories pantry, bathroom, wardrop and bar systems*

**Fabrika (Factory):**

Adres (Address): Kemalpaşa O.S.B. Ansızca San. Sit. Sk. No: 346/A 35170 Kemalpaşa  
**İZMİR TURKEY**

Tel: +90 232 878 00 15 – Fax: +90 232 878 61 74

**Web: [www.domodek.com](http://www.domodek.com)**

E-mail: [bilgi@domodek.com](mailto:bilgi@domodek.com)



0536 353 02 02

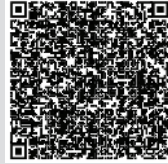

**Made in Turkey**

**TSEK**

